

Doorsnede B-B

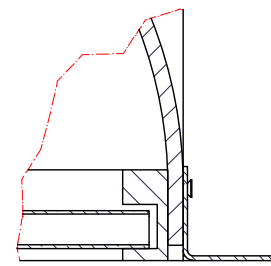

Detail C (1 : 5)

Afsluitbaar d.m.v. hangslot
(Niet meegeleverd)

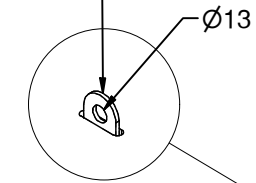

Detail F (1 : 5)

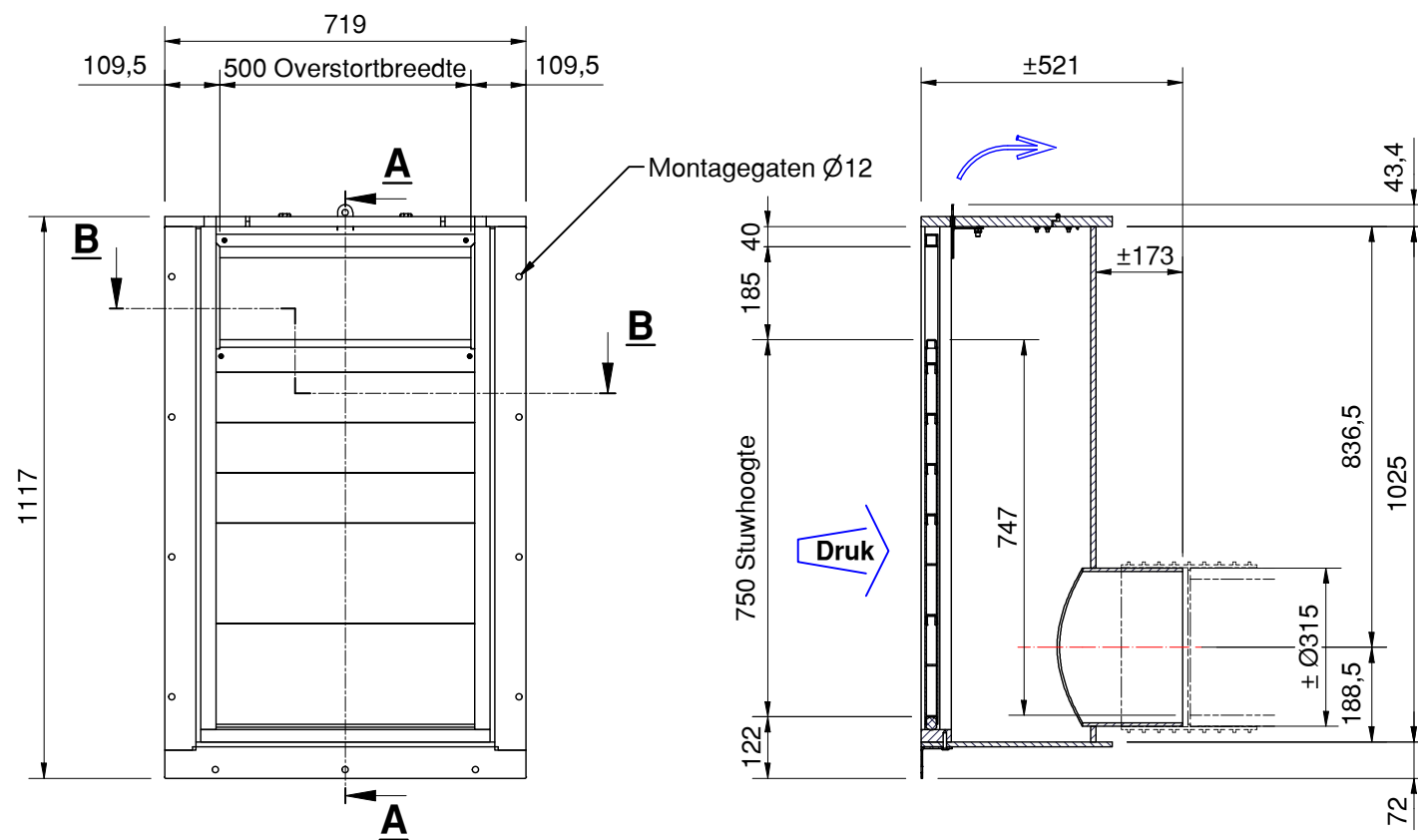

Vooraanzicht (1 : 15)

Doorsnede A-A

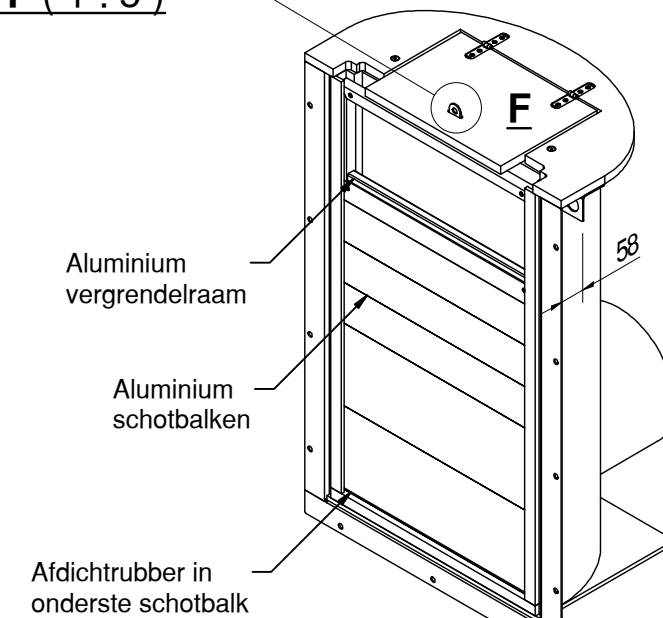

- Materiaal ;

- Alle stalen onderdelen zijn AISI 304 (L), tenzij anders aangegeven.
- Alle bevestigingsmiddelen zijn AISI 316 (A4).
- Alle kunststof onderdelen zijn HDPE, tenzij anders aangegeven.
- EPDM afdichtrubber.

Company	Waterschap Limburg	The design and technical information appearing on this drawing is the property of KWT Holding and is disclosed in confidence. It is not to be copied, reproduced, revealed, to or appropriated by others, either in whole or in part, without prior access written consent from KWT Holding.			
Project company	P360057 - 702620 Pilot Extra Boerenstuwen	Tenzij anders aangegeven ; Maatvoering in mm Peilmaten in meters t.o.v. NAP			
Project KWT	KWT Overstortput type KOP	Pending TER GOEDKEURING			
Description	KOP 304L, 500x750x200-TWK315	Designed	Checked	Date 14-10-2020	
	Wentelploeg 42 8256 SN Biddinghuizen The Netherlands Tel. : +31 (0)321 33 55 66 Fax : +31 (0)321 33 55 76 E-mail : info@kwt.nl Internet : www.kwt.nl	Detailed	Checked	Date 14-10-2020	
		Projection		37 kg	Sheet / size A3
		Drawing nr.	Company :	Rev.	
Member of BERGSCHENHOEK GROEP		KWT :	201909.010.KWT.A	1	