

Dwarsprofiel DP-01
t.o.v. as ALM - Middle
bij metreering 448.043
Schaal 1:250 (lengte) / 150 (hoogte)
-5.000m t.o.v. NAP

Ontwerp	Hoogte	Afstand
	0.75	
Bestaand	Hoogte	Afstand
	0.75	

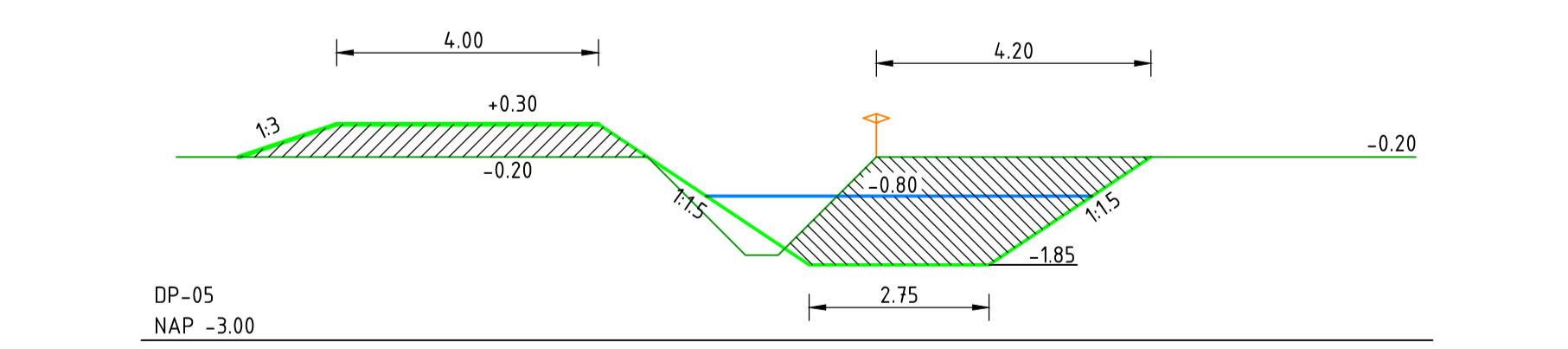

dwarsprofielen
schaal 1:100

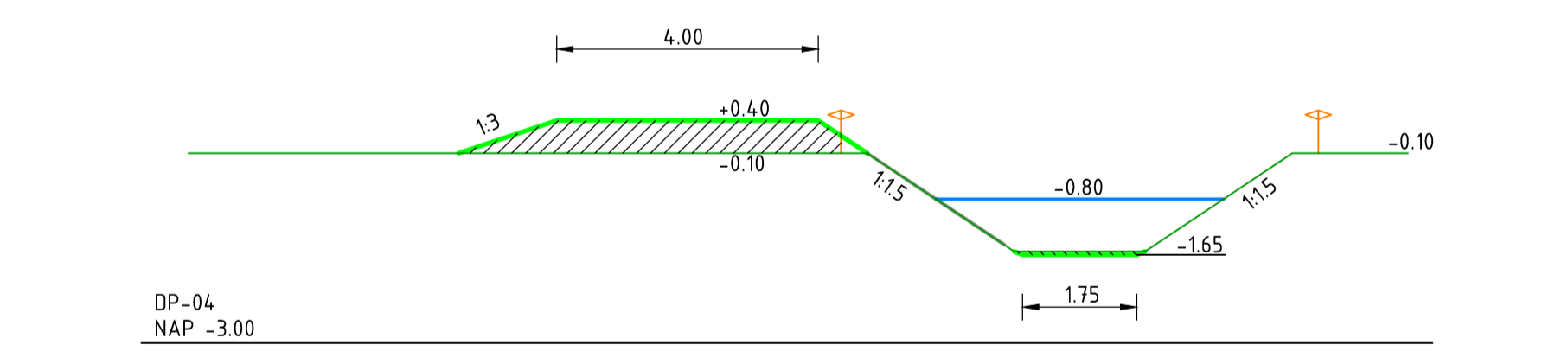
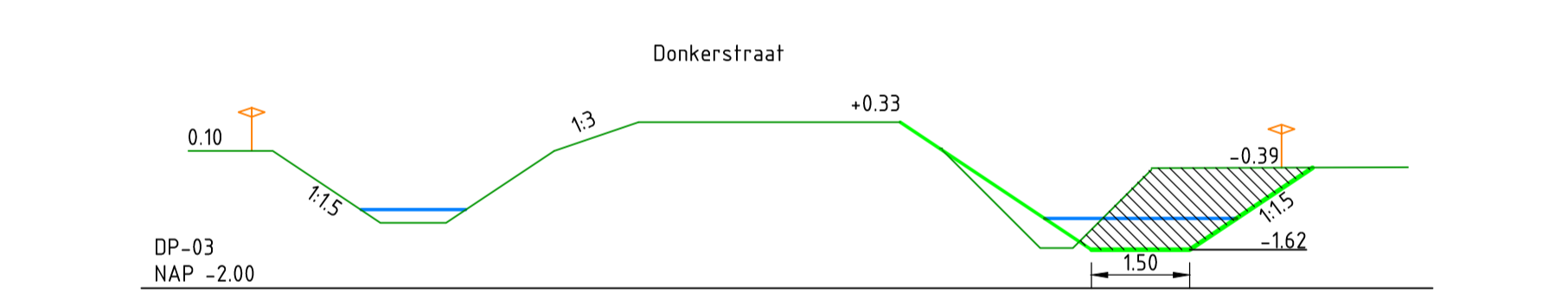
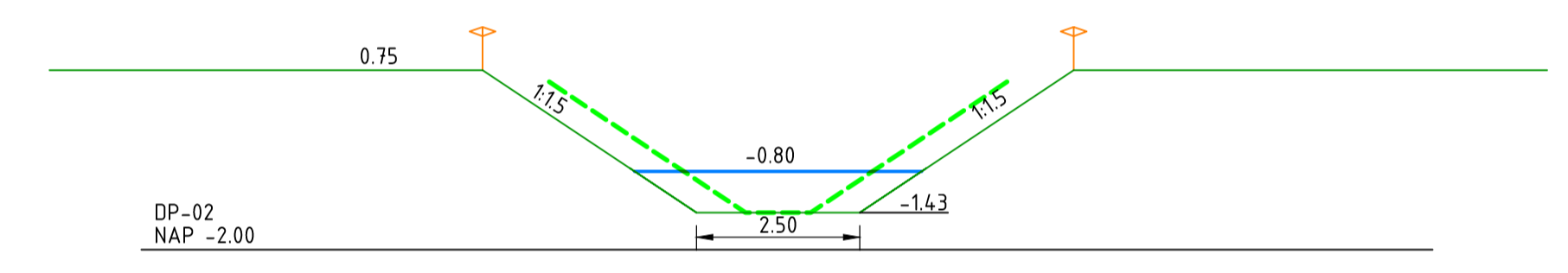
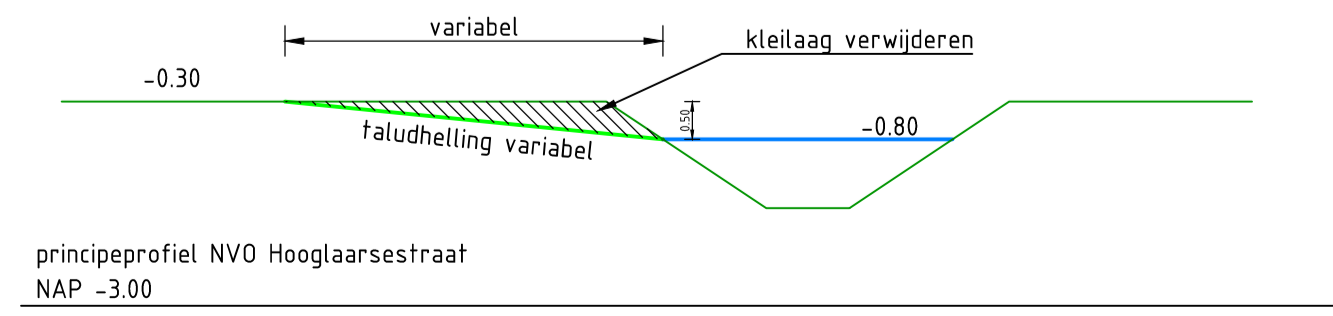
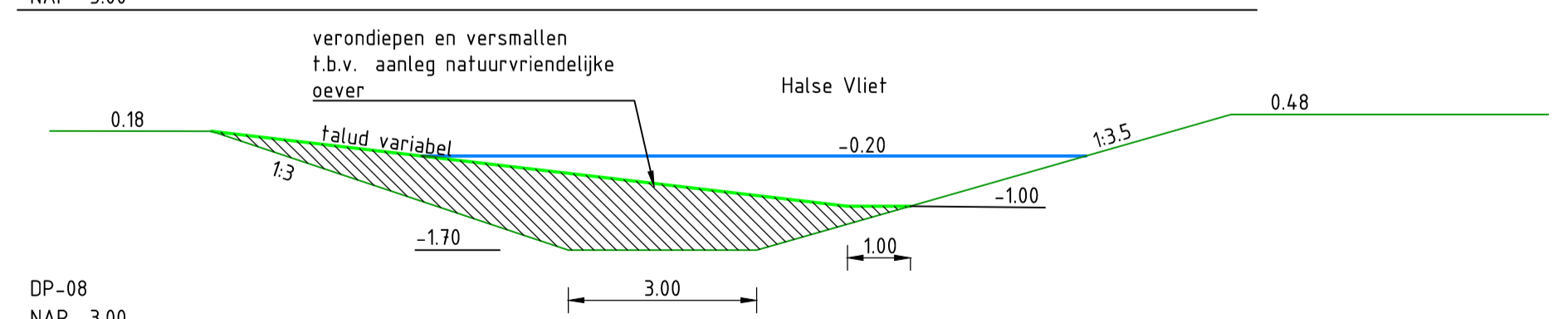
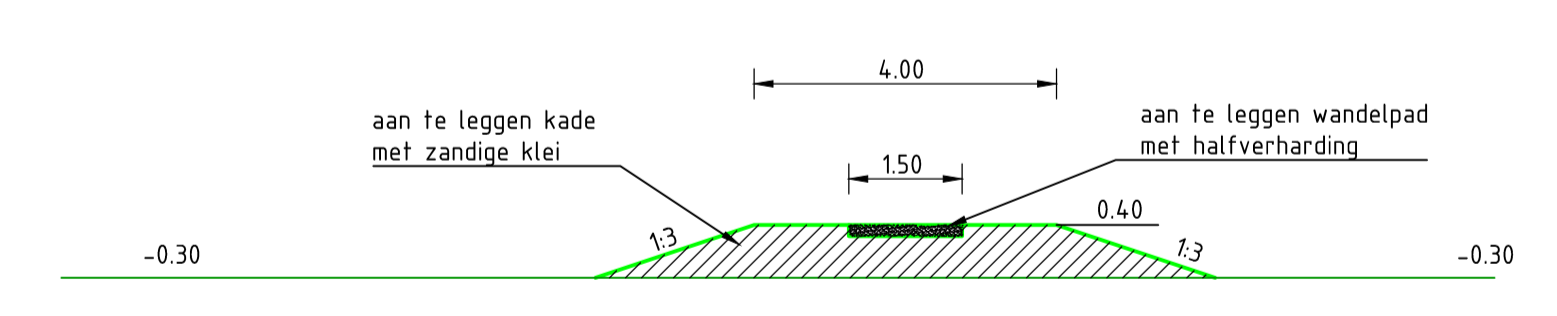
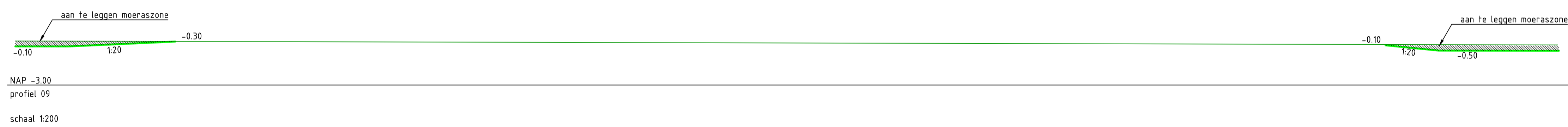

principeprofiel NVO Hoogaarsestraat
NAP -3.00

Legenda

- As
- Bestaande kadastrale grens
- Ontgraven
- Aanvullen
- Waterlijn
- Bestaande situatie
- Nieuwe situatie

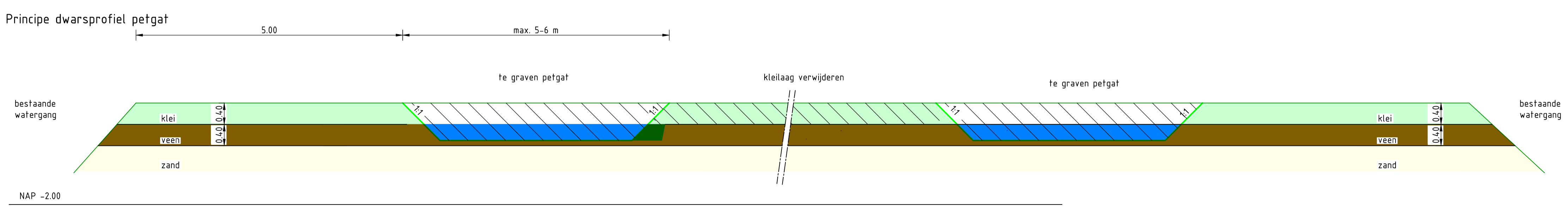
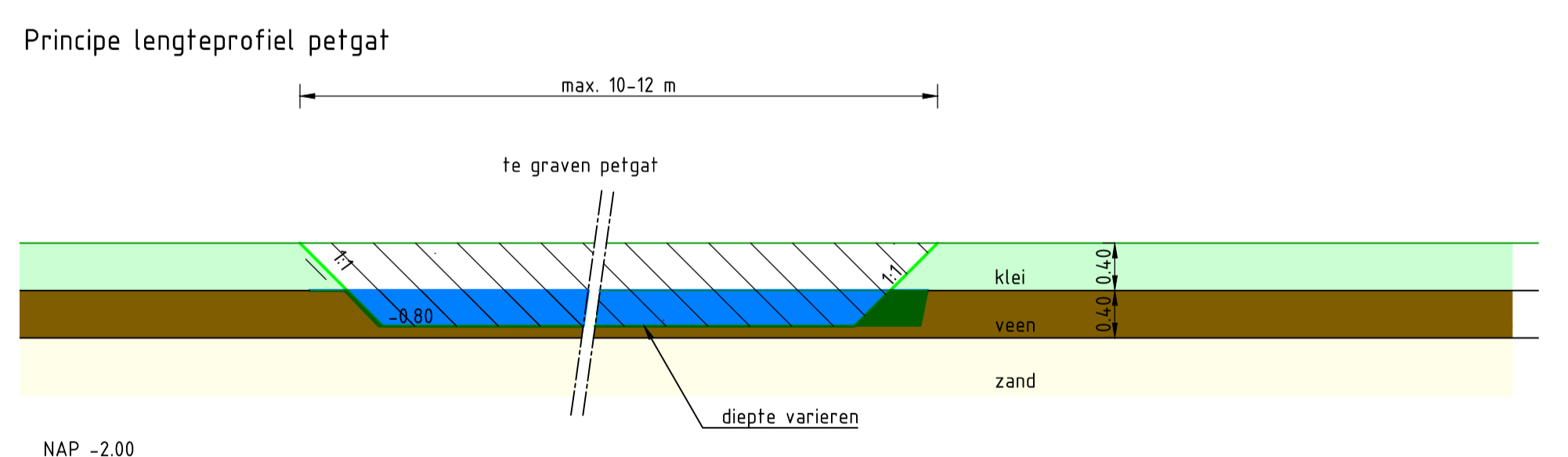

versie	omschrijving wijzigingen	max. review	van	tot
V08	Datum: 12-06-2023	Get.: R. Jansen	Con.: R. Jansen	Vrij.: A. ter Harmsel
V09	Datum: 04-10-2023	Get.: S. Thio	Con.: R. Jansen	Vrij.: A. ter Harmsel

Opdrachtgever Contact

Advies- en Ingenieursorganisatie Architect

ARCADIS

Project Noordrand Midden-west Contact: Arjan ter Harmsel

Projectnummer: Definitief Ontwerp
Fase: Definitief Ontwerp
Onderwerp: dwarsprofielen Strijpen de Berk

Schaal: zie tekening
Contractnummer: Bladformaat: A++
Tekeningnummer: Bladnummer: 1 van 1
Status: definitief
Versie: 2