

3D aanzicht zettingsconstructie

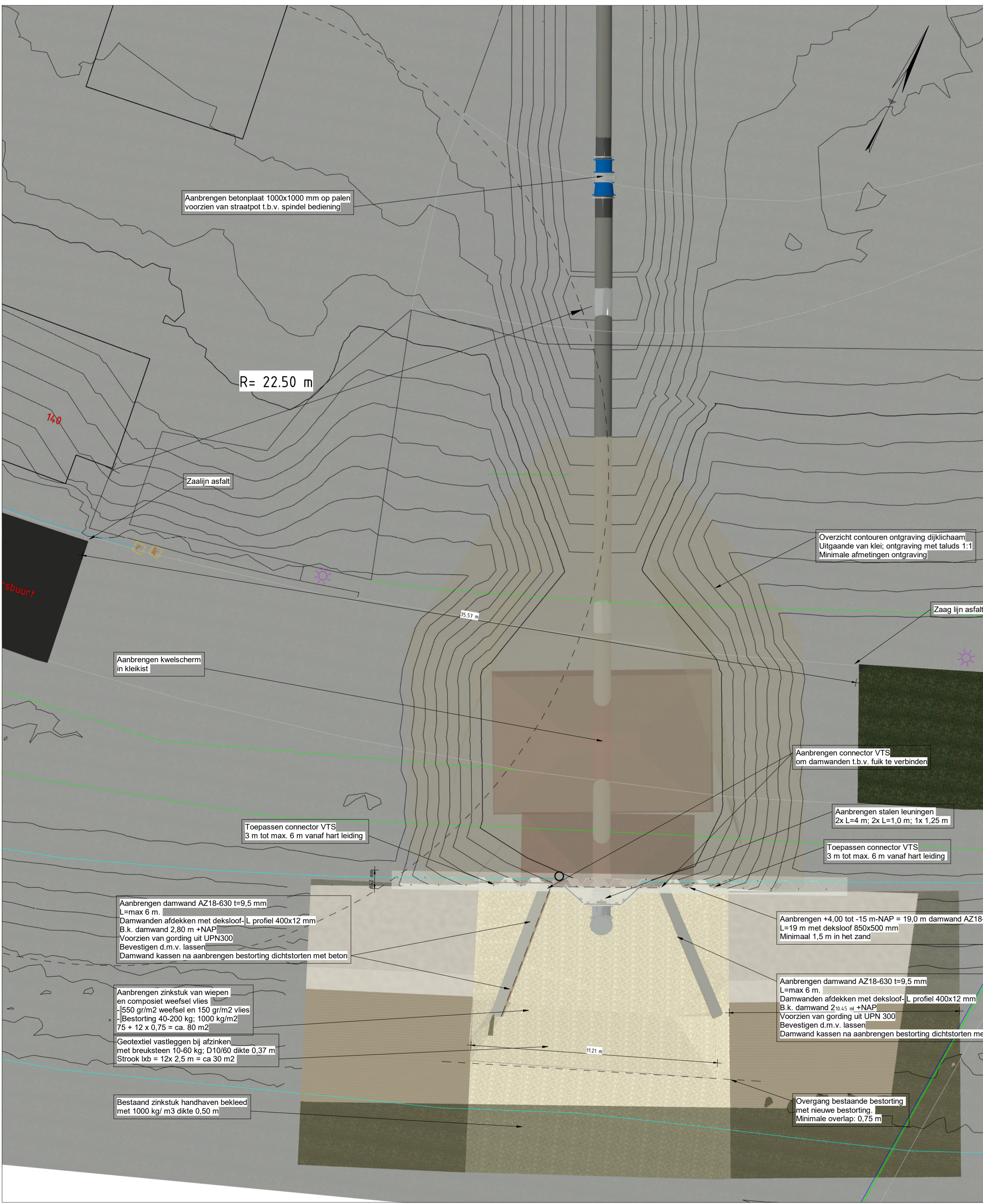

Nieuw trace - detail dijk aansluiting

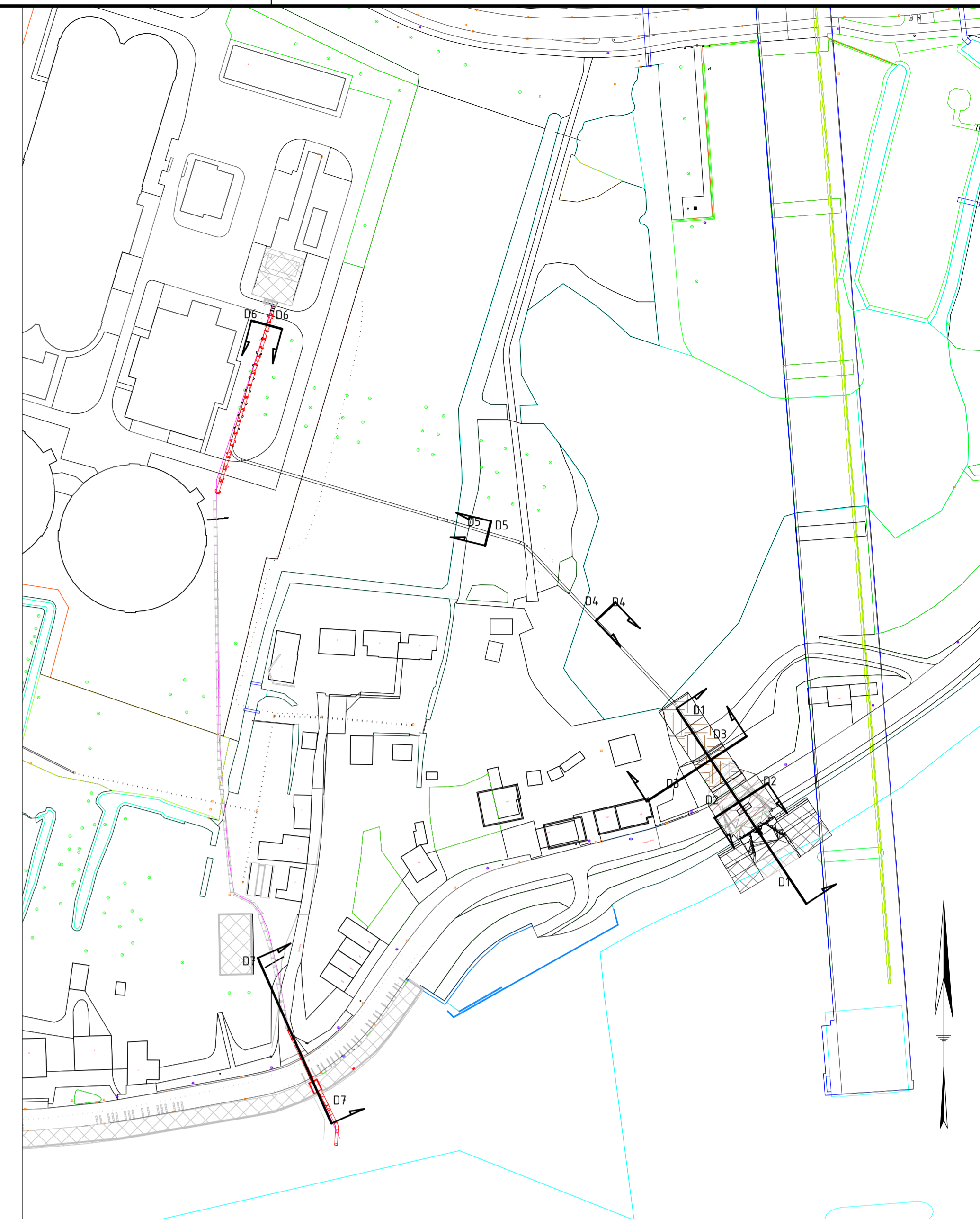
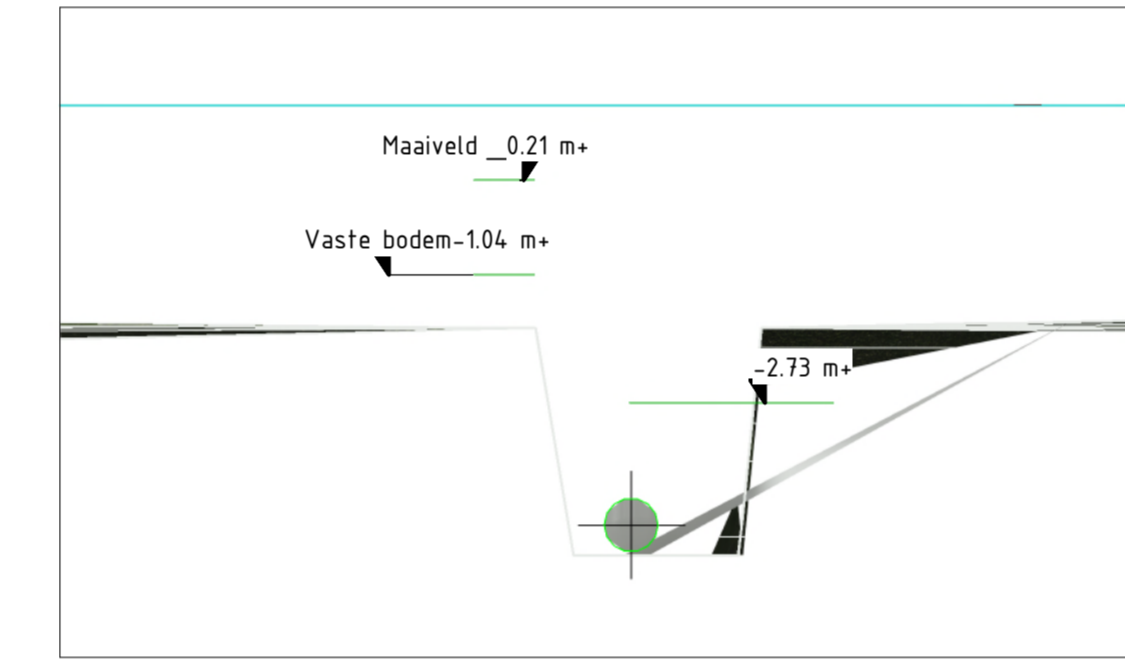

Doorsnede 4 - doorsnede Grote Wiel  
schaal 1: 100

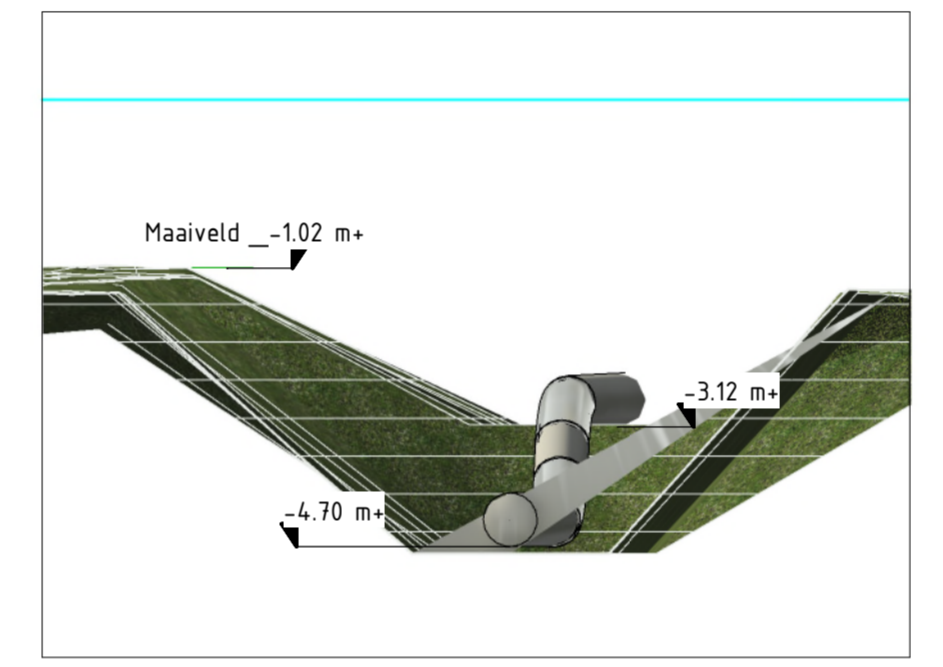

Doorsnede 5 - ontgraving t.p.v. zinker  
schaal 1: 100

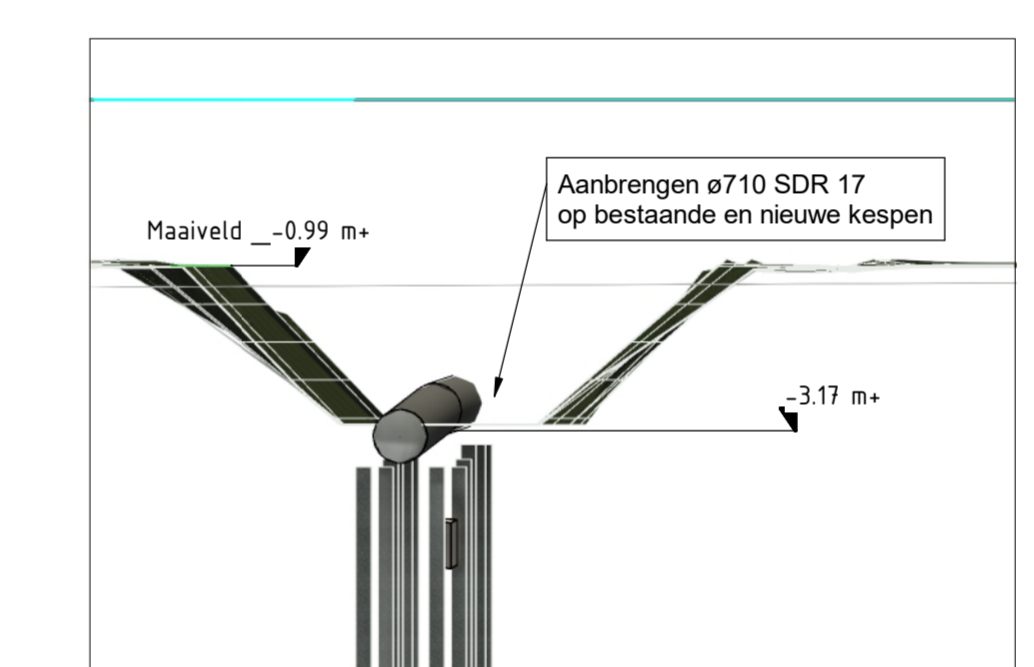

Doorsnede 6 - bestaand/ nieuw trace  
schaal 1: 100

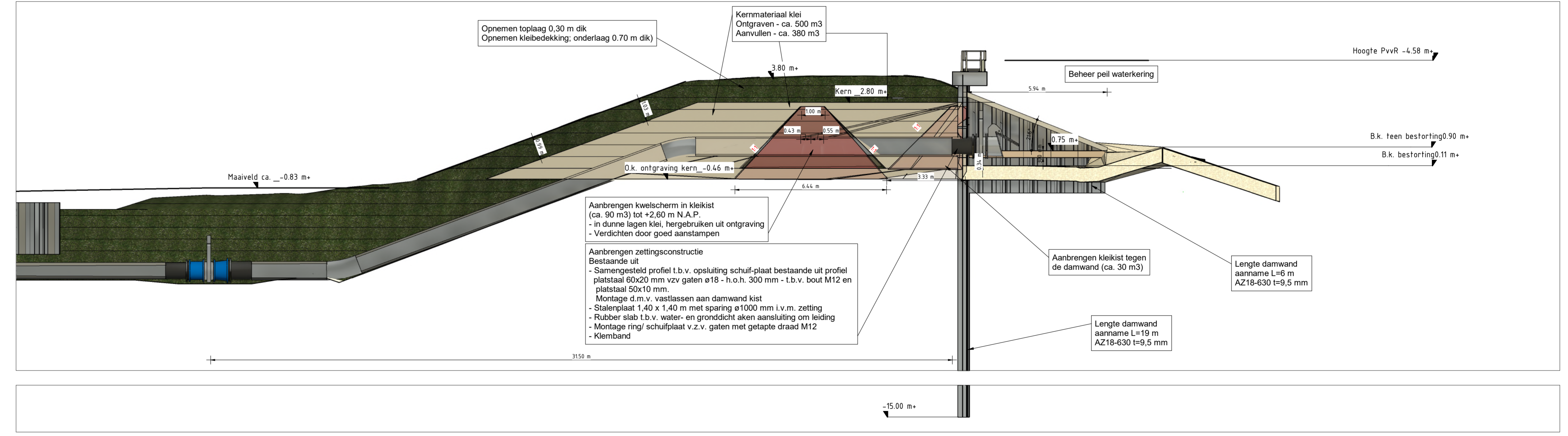

Doorsnede 1  
schaal 1: 100

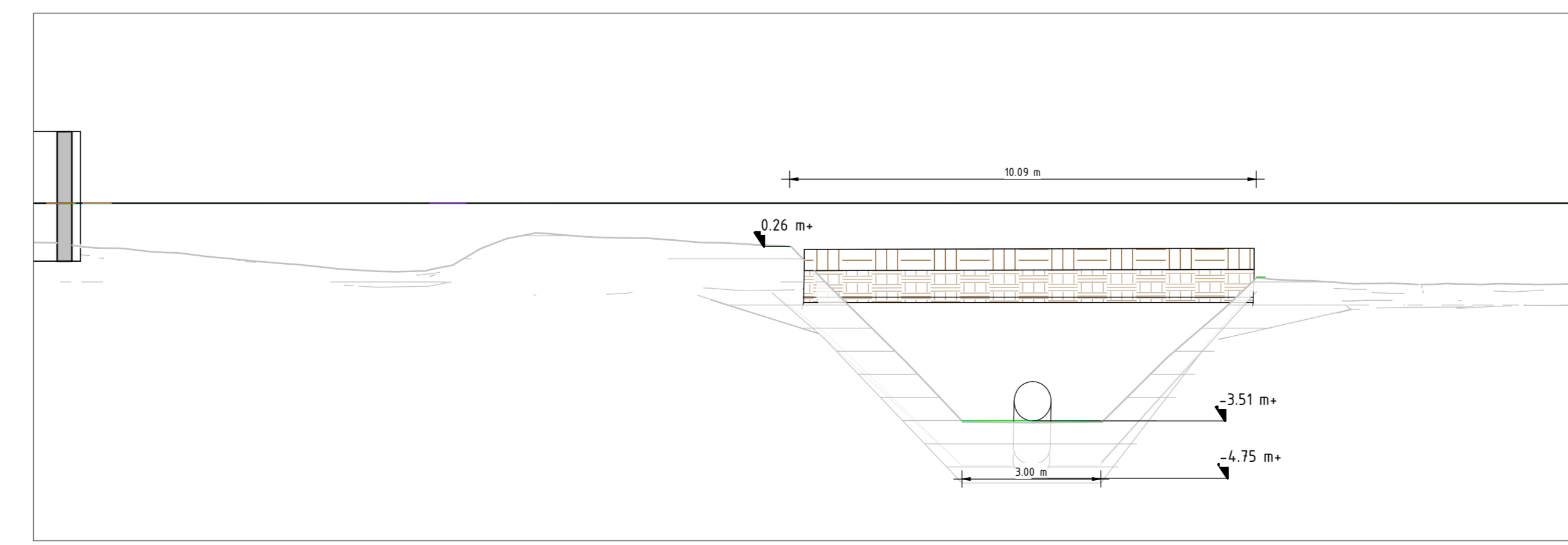

Doorsnede 3 - inrit Vissersbuurt 140  
schaal 1: 100

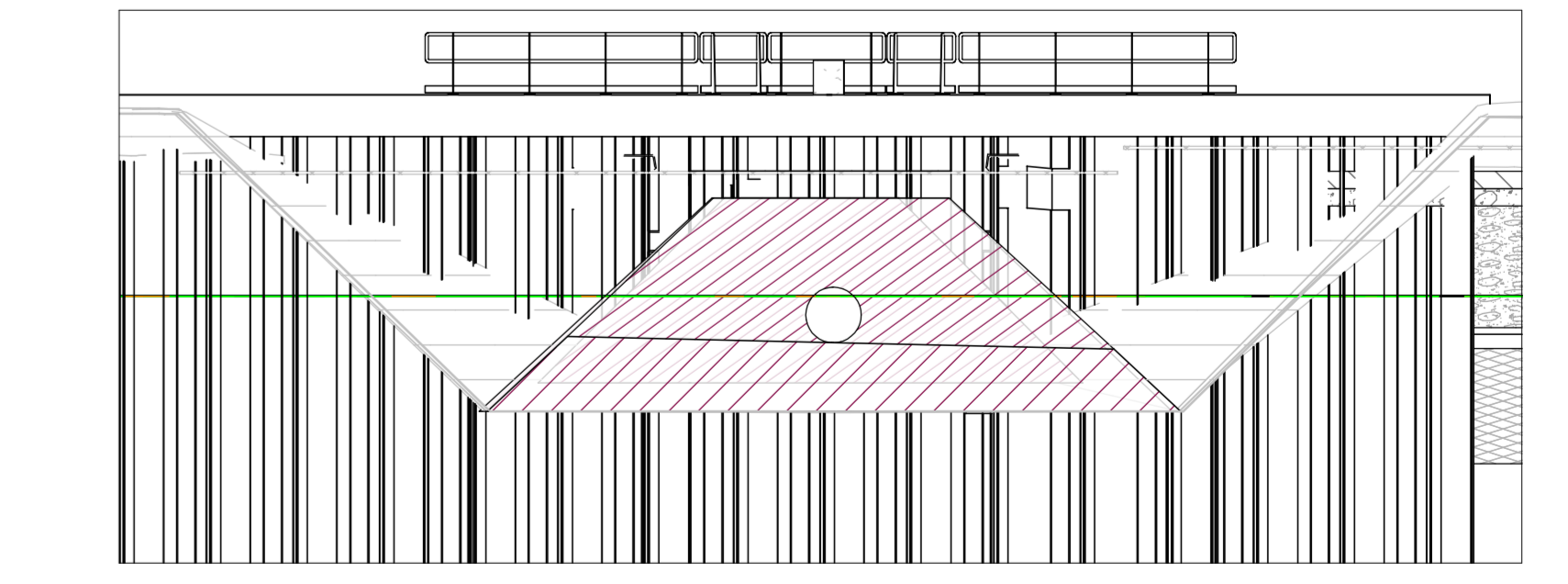

Doorsnede 2 - dijk doorkruising  
schaal 1: 100

Versie: Datum: Omschrijving:		Getekend: Gecontroleerd:	
Project: Effluentleiding Papendrecht Definitief ontwerp			
Onderdeel: Nieuwe dijk doorkruising	Datum: 18-10-2022	Blad: 2 van 6	
Projectnr: 100847	Postcode: 4000 AH	Status: Definitief	
Geplaatst: De Binnengordel 1	Postbus 199	Getekend: RA	
4000 SK, Tel: 034461 64 90 90	4000 AH, Tel: 034461 64 90 90	Gecontroleerd: GK	
URL: www.waterschaprivierland.nl		Besteknr: --	
		Schaal: As indicated	
		Formaat: A0	
Tekeningnr: GVL-ZTW-TekC_2_401			