



LM design

bouwkundig teken- en adviesbureau

Birkstraat 95-3
3768 HD Soest

Tel 035-6023424
info@lmdesign.nl

P R O J E C T

26 woningen te Barneveld

O P D R A C H T G E V E R

Van de Kolk Ontwikkeling BV
Koningsweg 29 3886 KC Garderen

O N D E R D E E L

PRINCIPE DETAILS

O M S C H R I J V I N G

Aanvraag Omgevingsvergunning

Schaal	1:5	Formaat	A3
--------	-----	---------	----

Datum	28-01-2019	Getekend	PV
-------	------------	----------	----

Gewijzigd

A	20-03-2019	F
---	------------	---

B	26-03-2019	G
---	------------	---

C		H
---	--	---

D		I
---	--	---

E		J
---	--	---

ROOZENBEEK ARCHITECT BNA

Blauwgras 9
3776 NC Stroe

Tel 0342.44.39.69
info@roozenbeek.nl

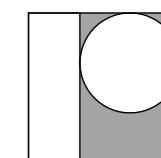

ROOZENBEEK

W E R K N R
3026

B L A D N R
DE01

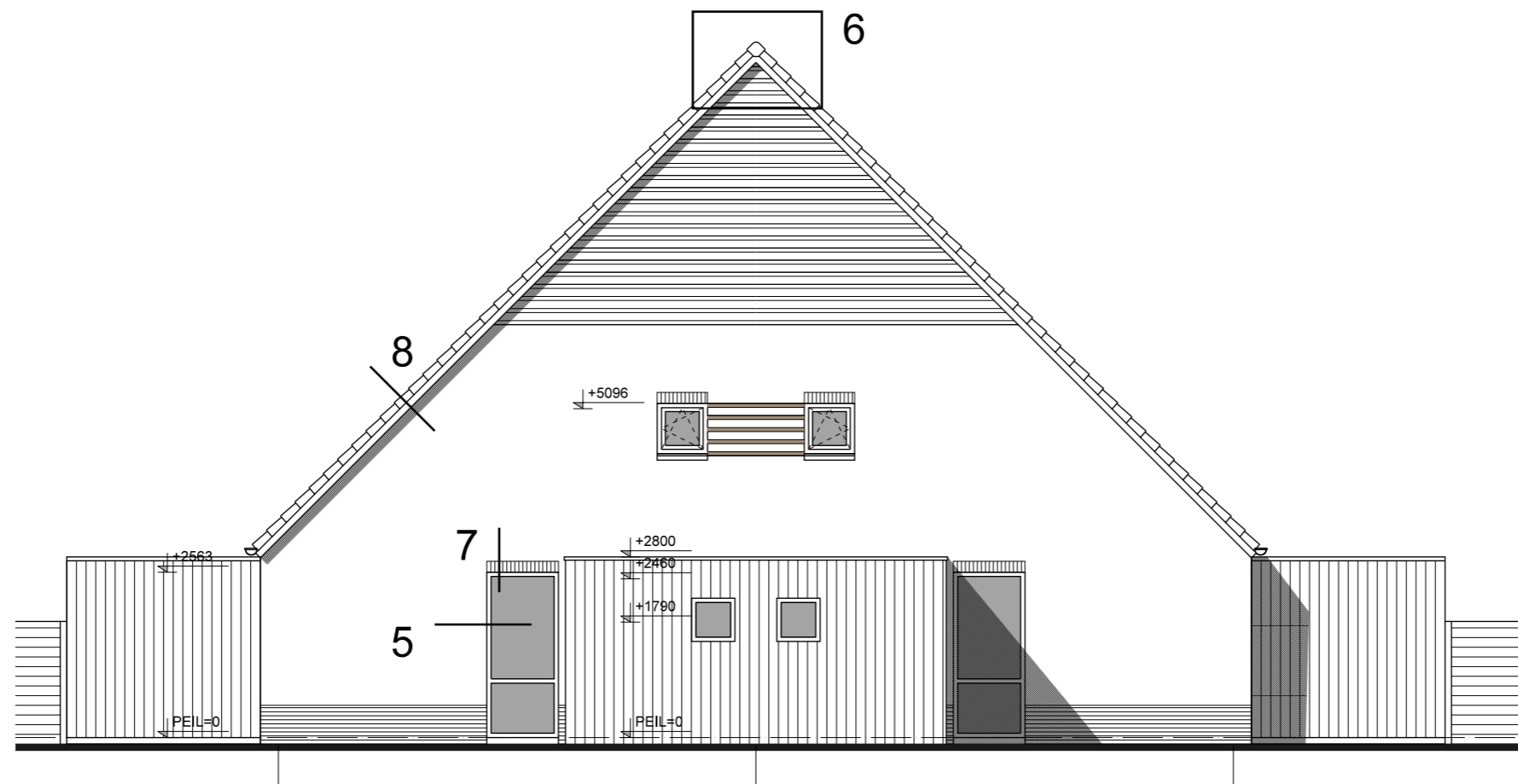
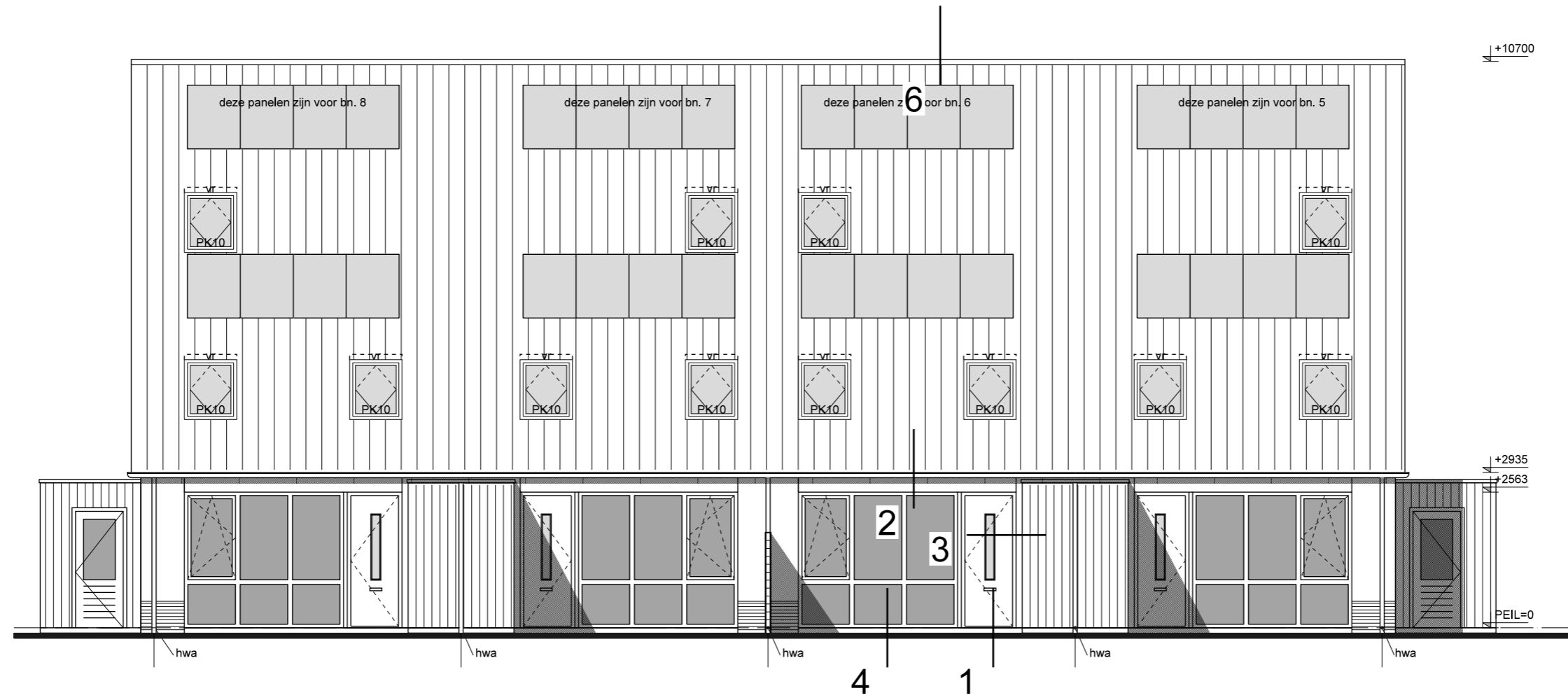

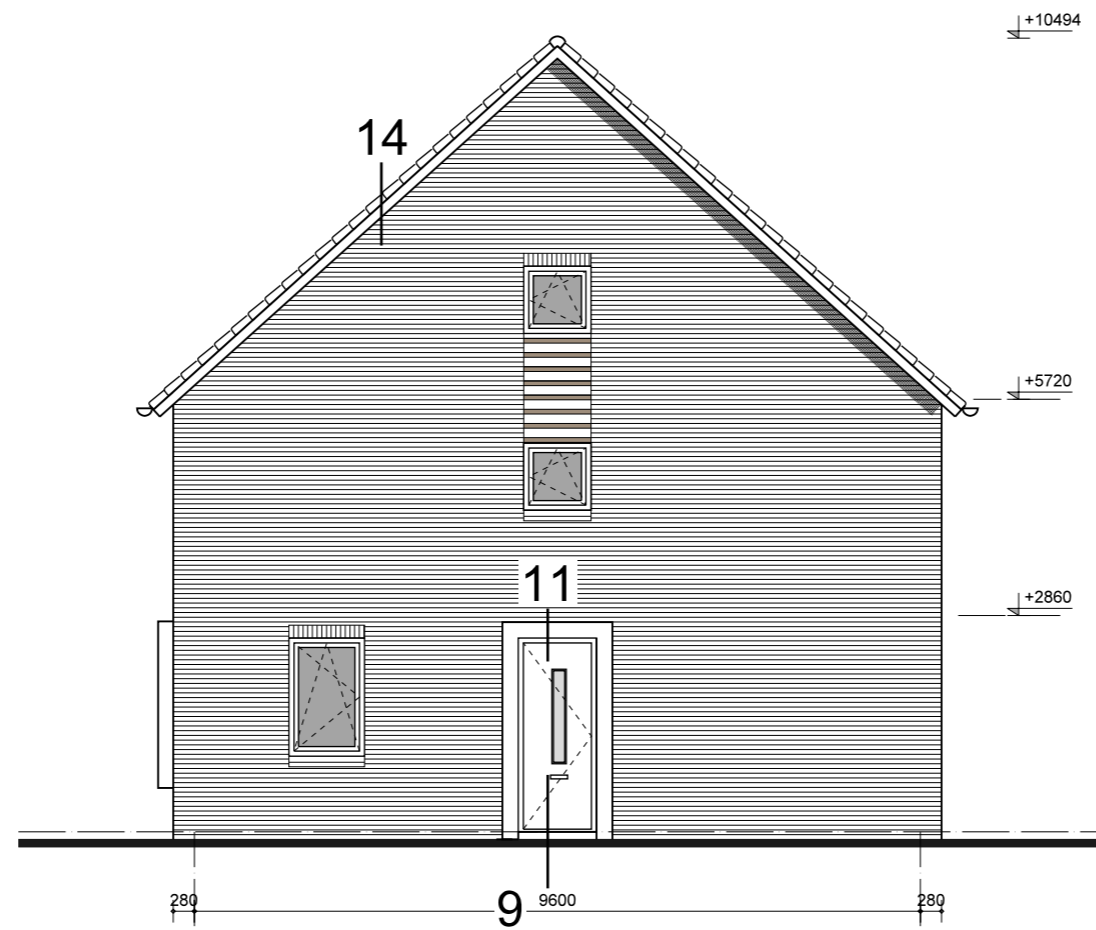
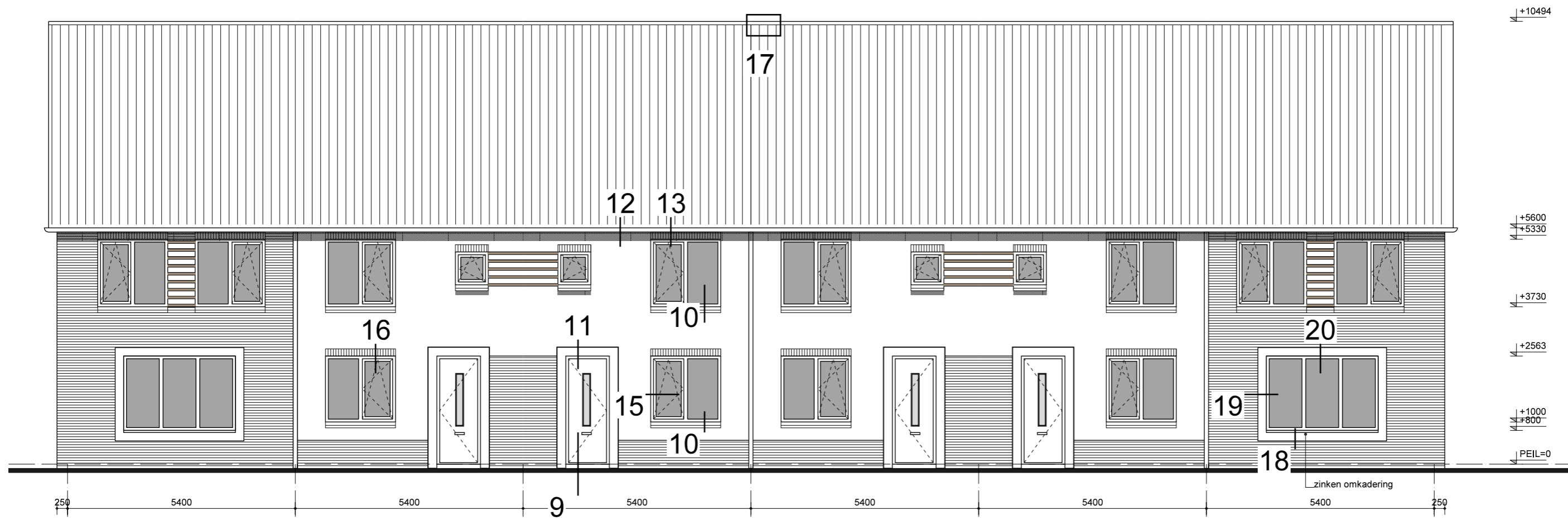

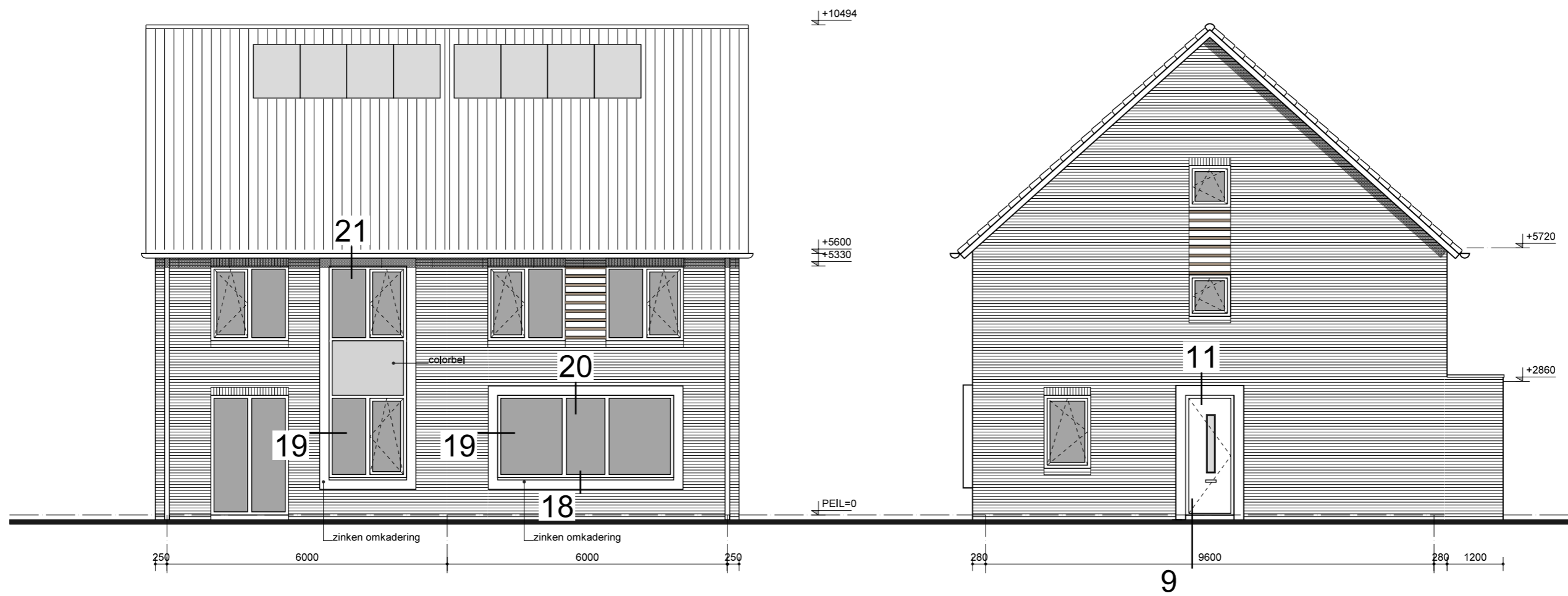

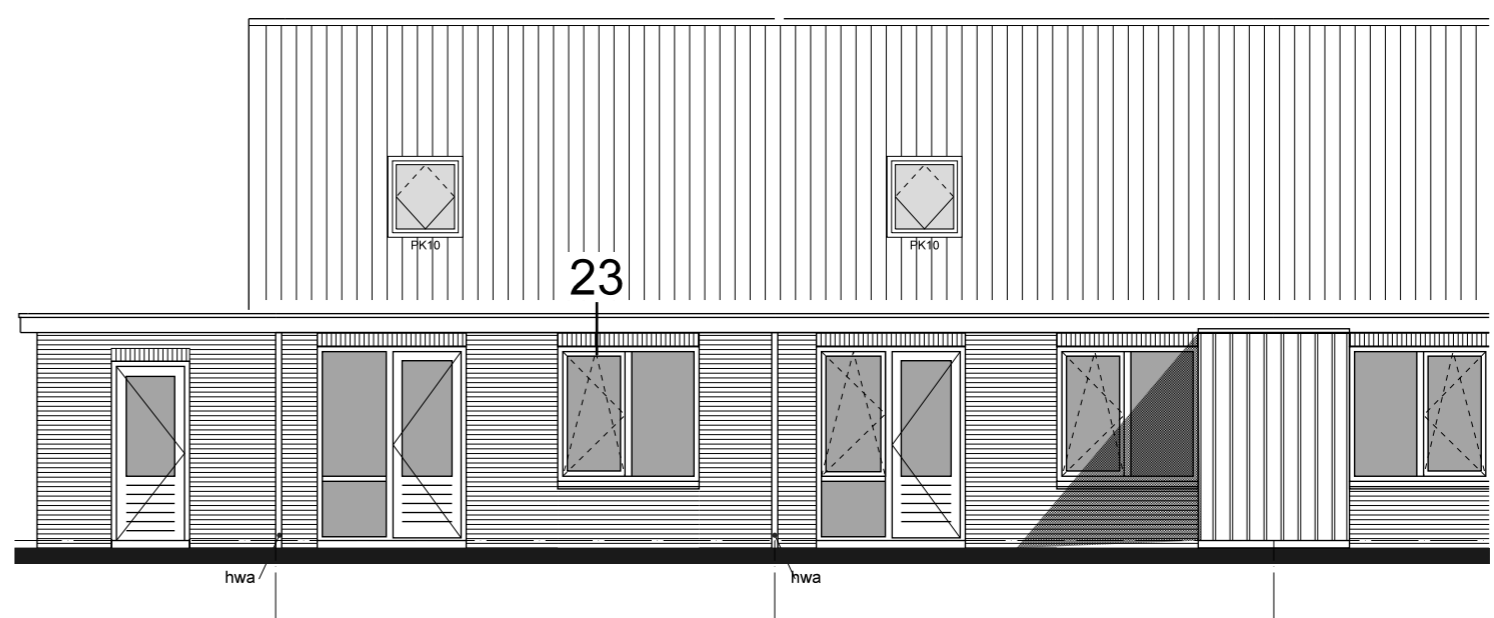
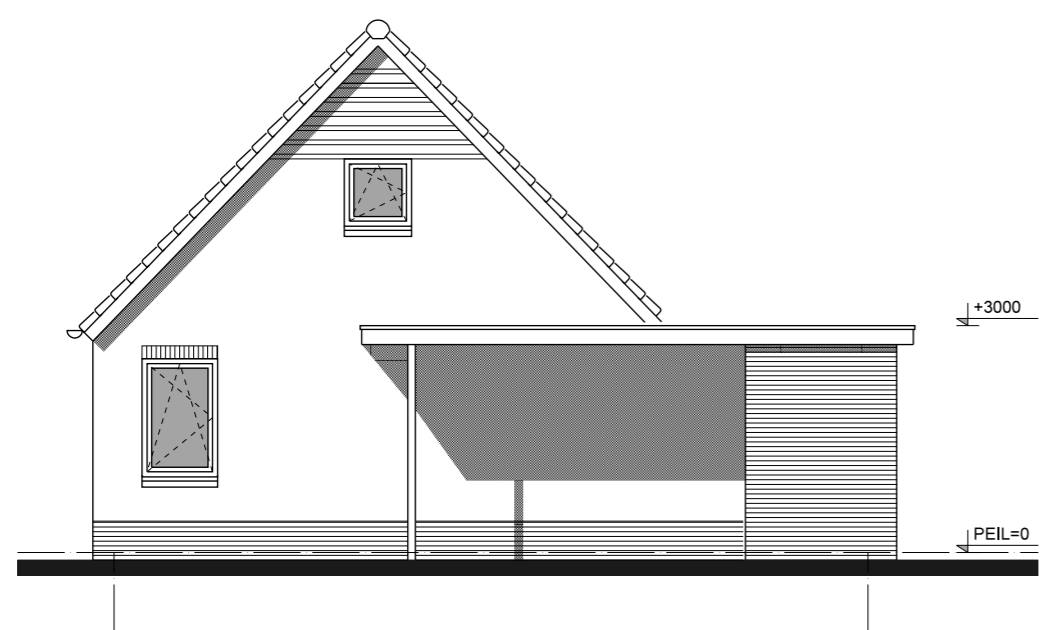
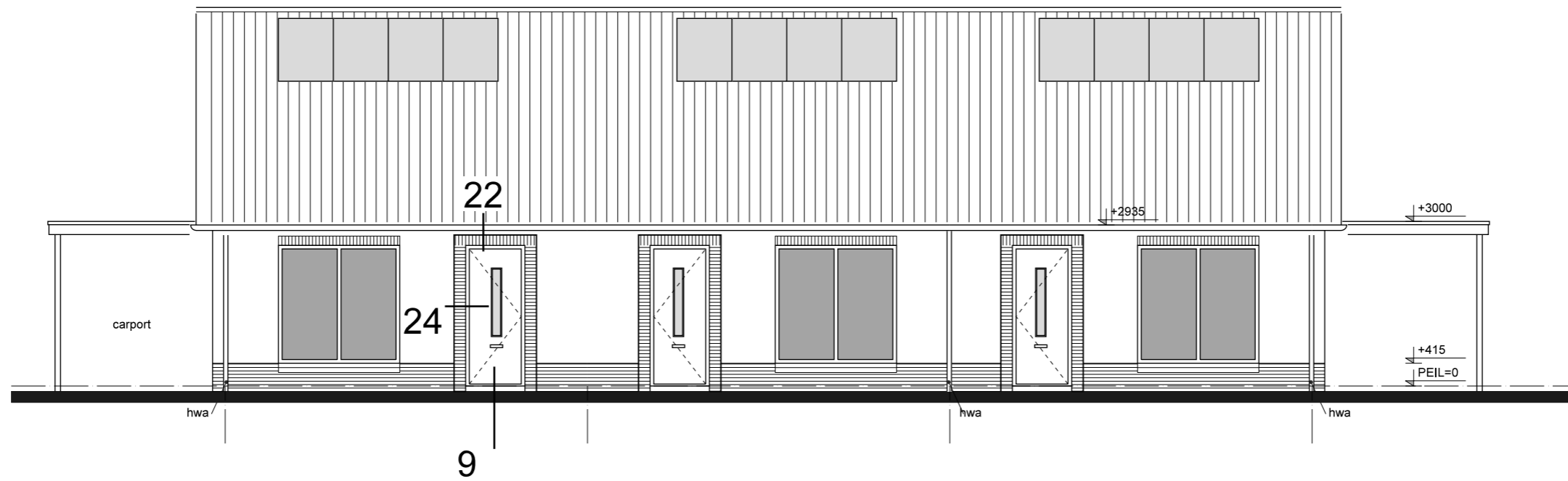

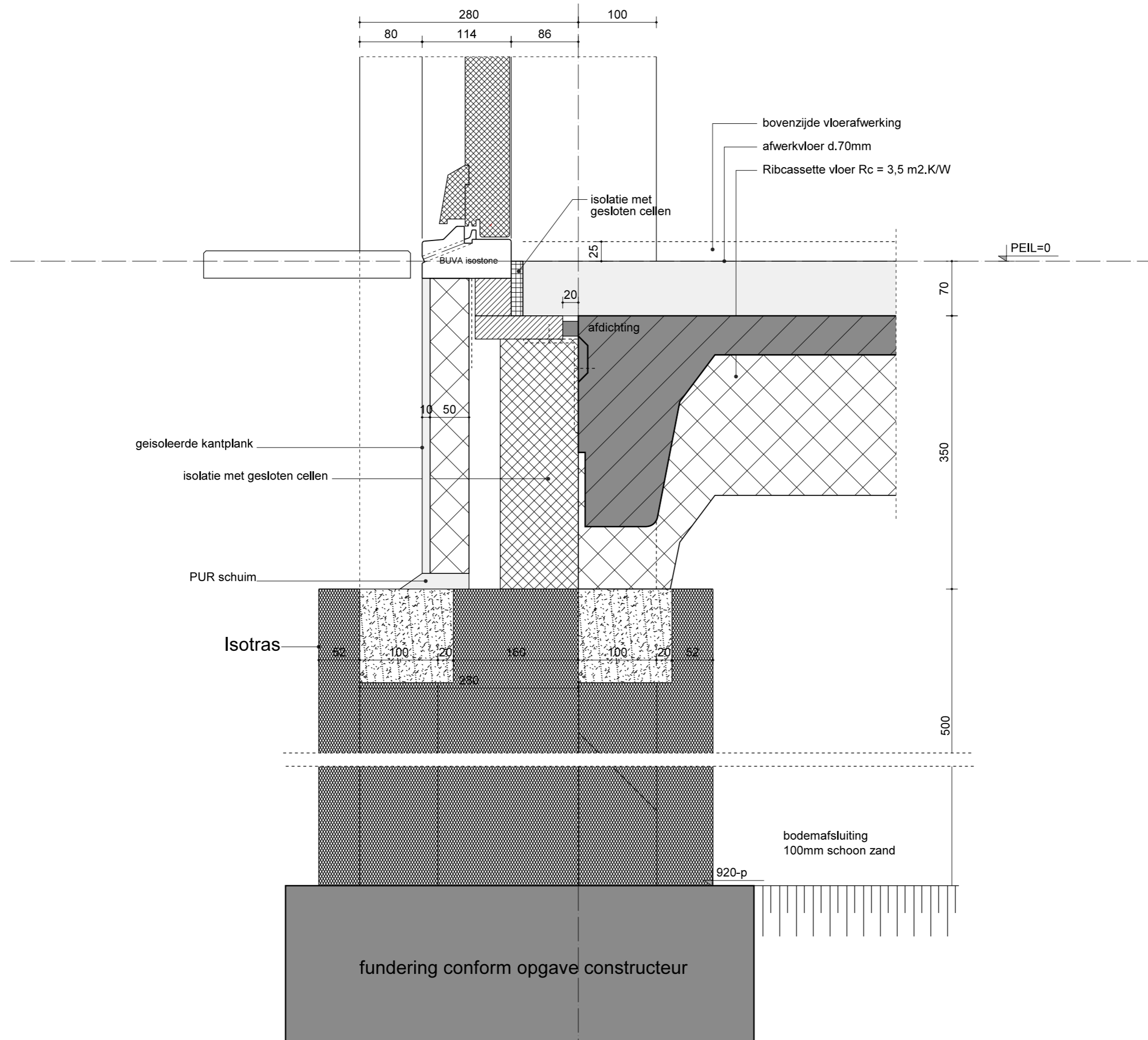

detail 1

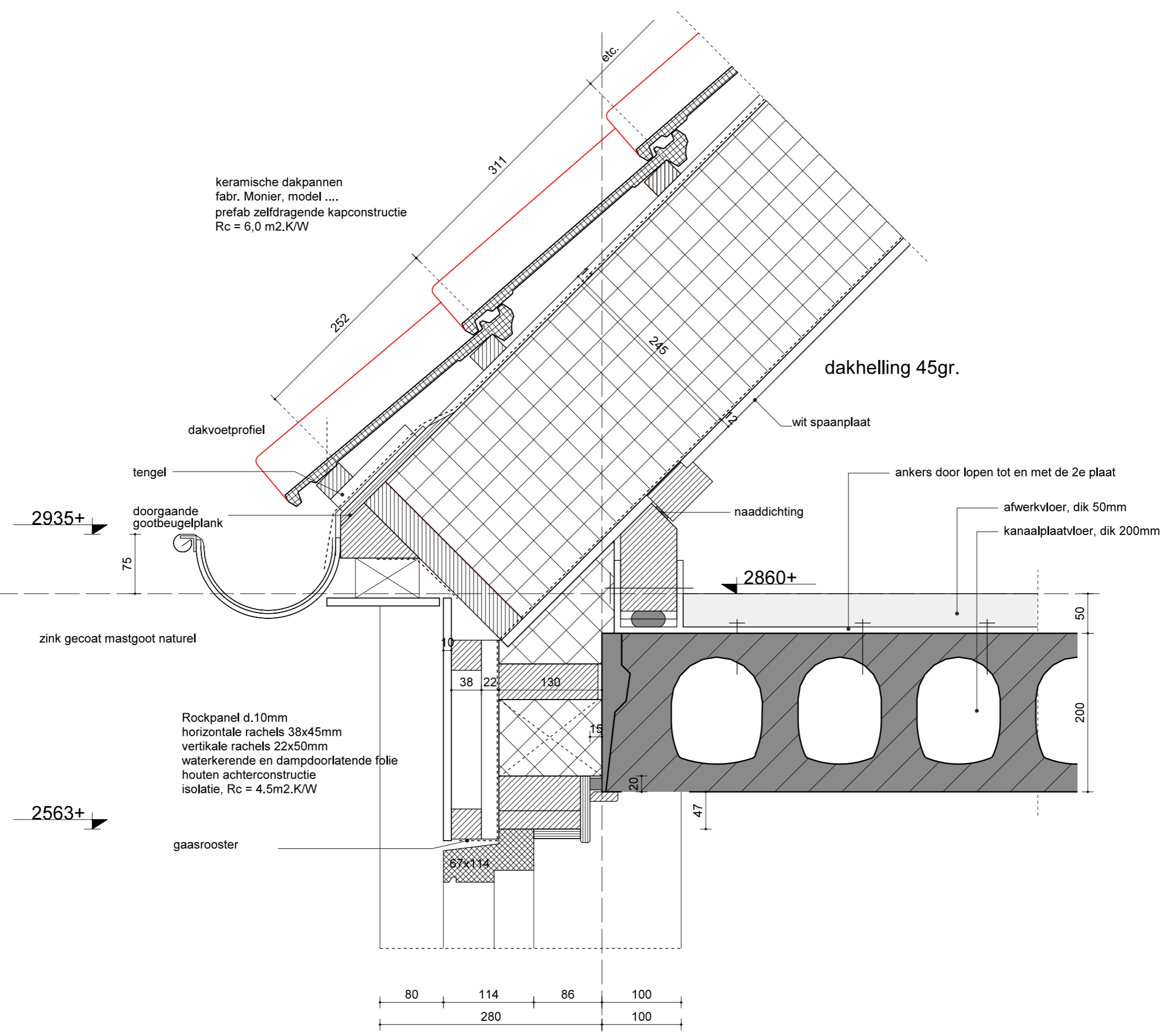

detail 2

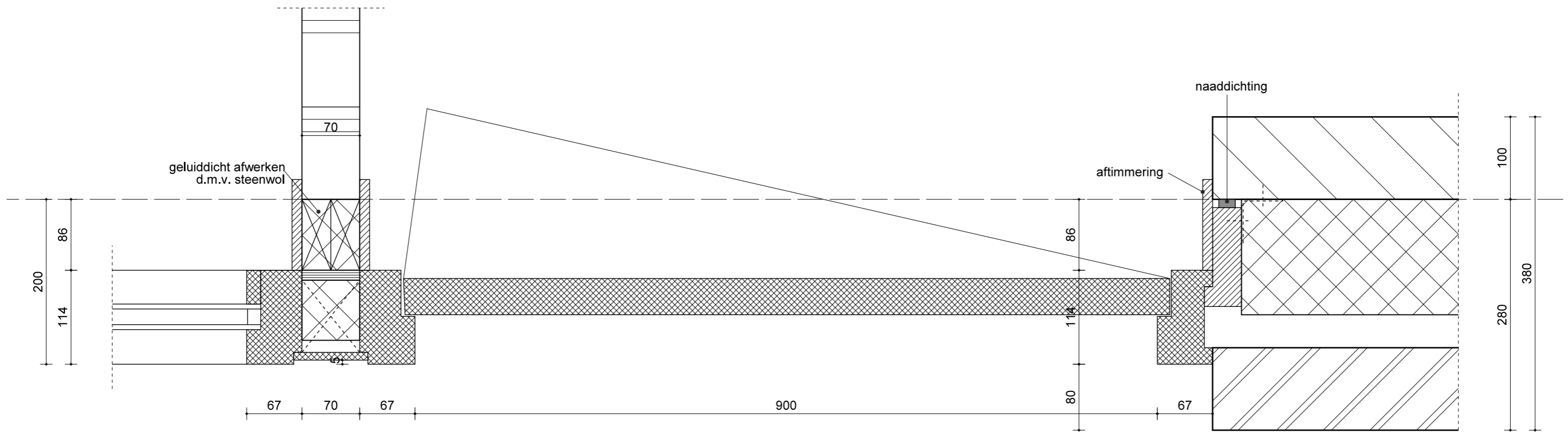

detail 3

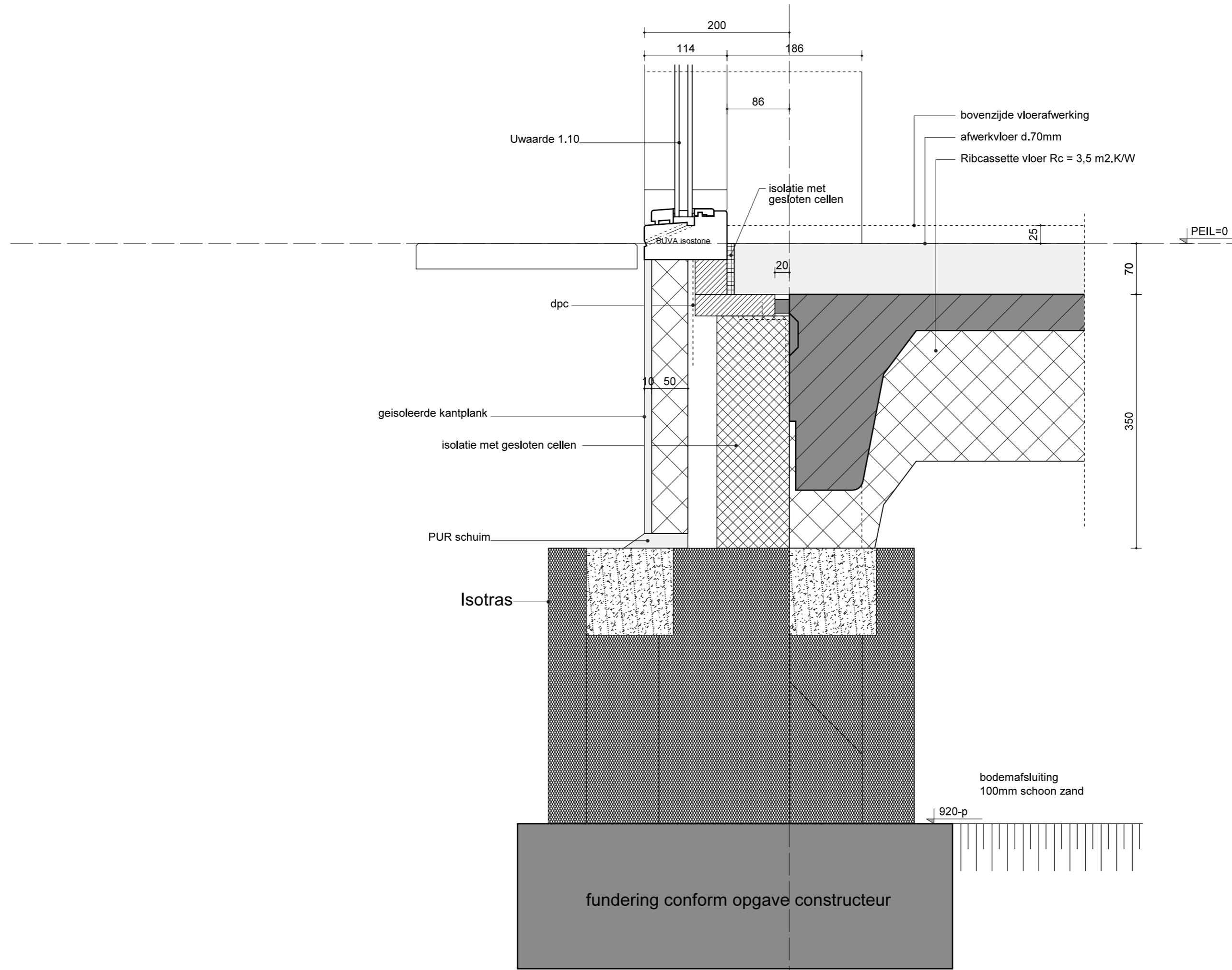

detail 4

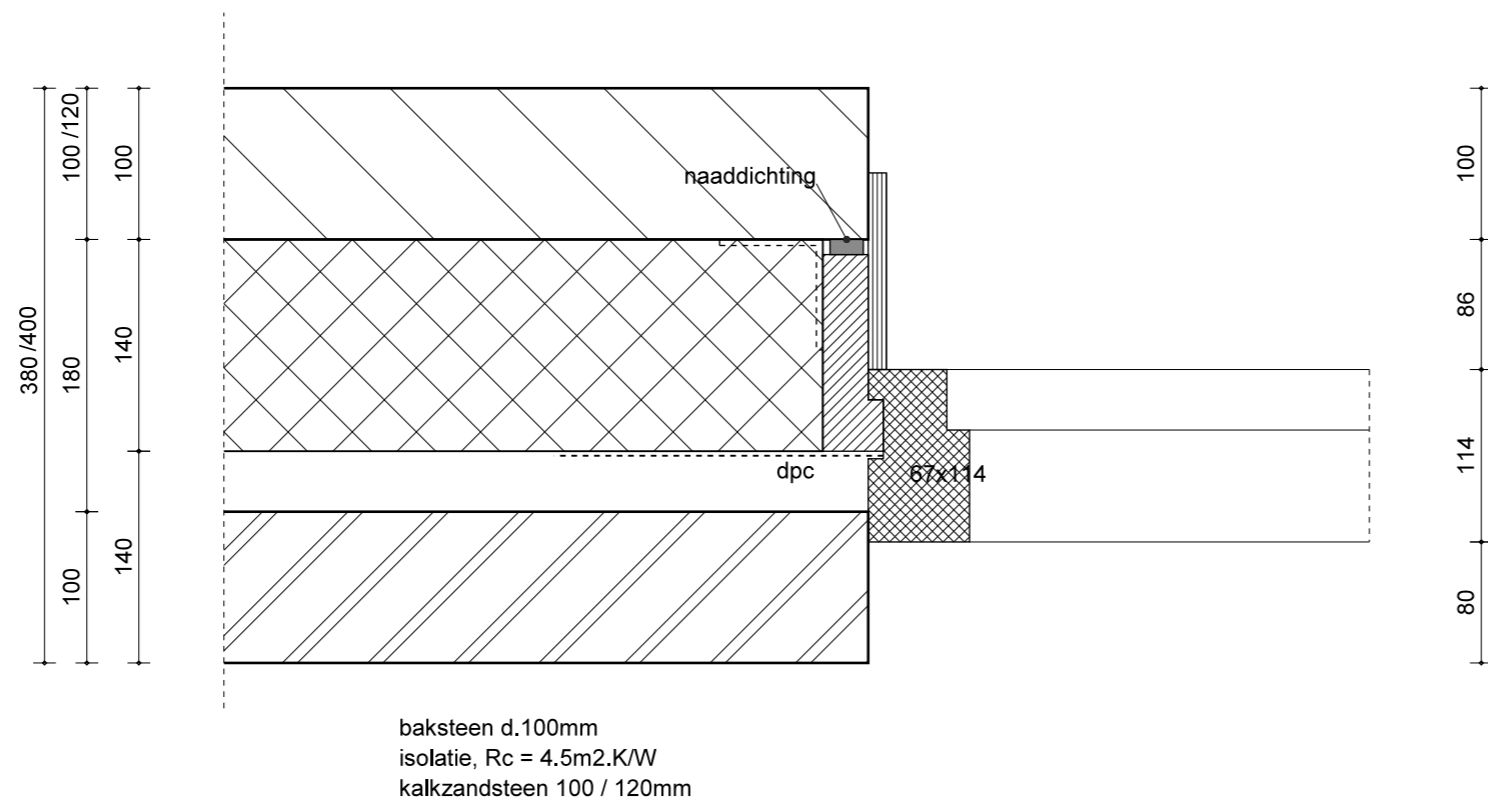

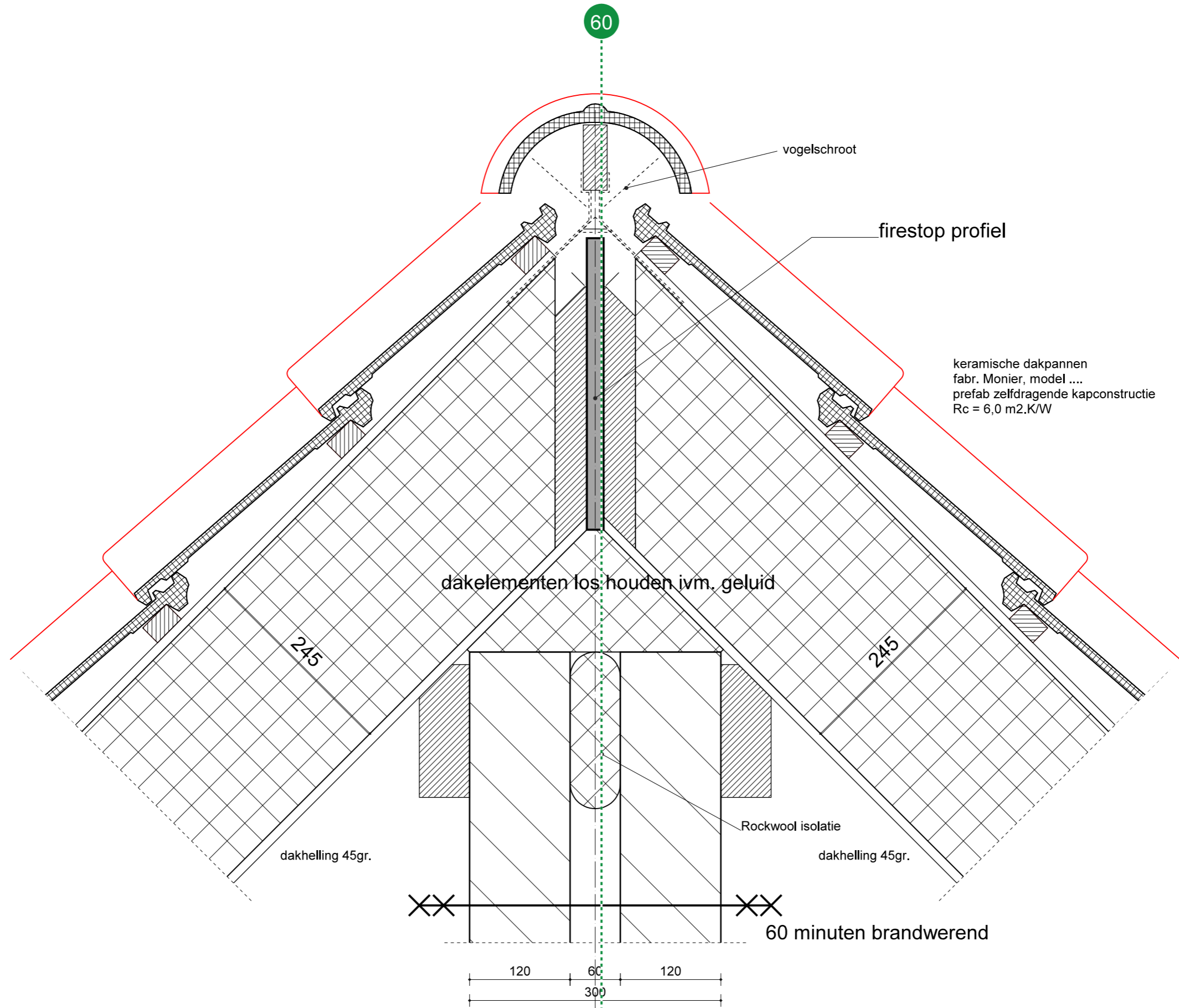

keramische dakpannen
 fabr. Monier, model
 prefab zelfdragende kapconstructie
 Rc = 6,0 m2.K/W

dakelementen los houden ivm. geluid

245

245

dakhelling 45gr.

dakhelling 45gr.

Rockwool isolatie

60 minuten brandwerend

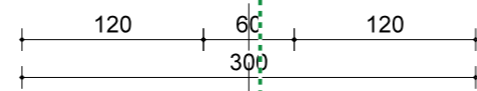

Detail afstemmen met kapleverancier t.a.v. geluid !

$l_{u;k} > 0 \text{ dB}$ en $l_{co} > +5 \text{ dB}$

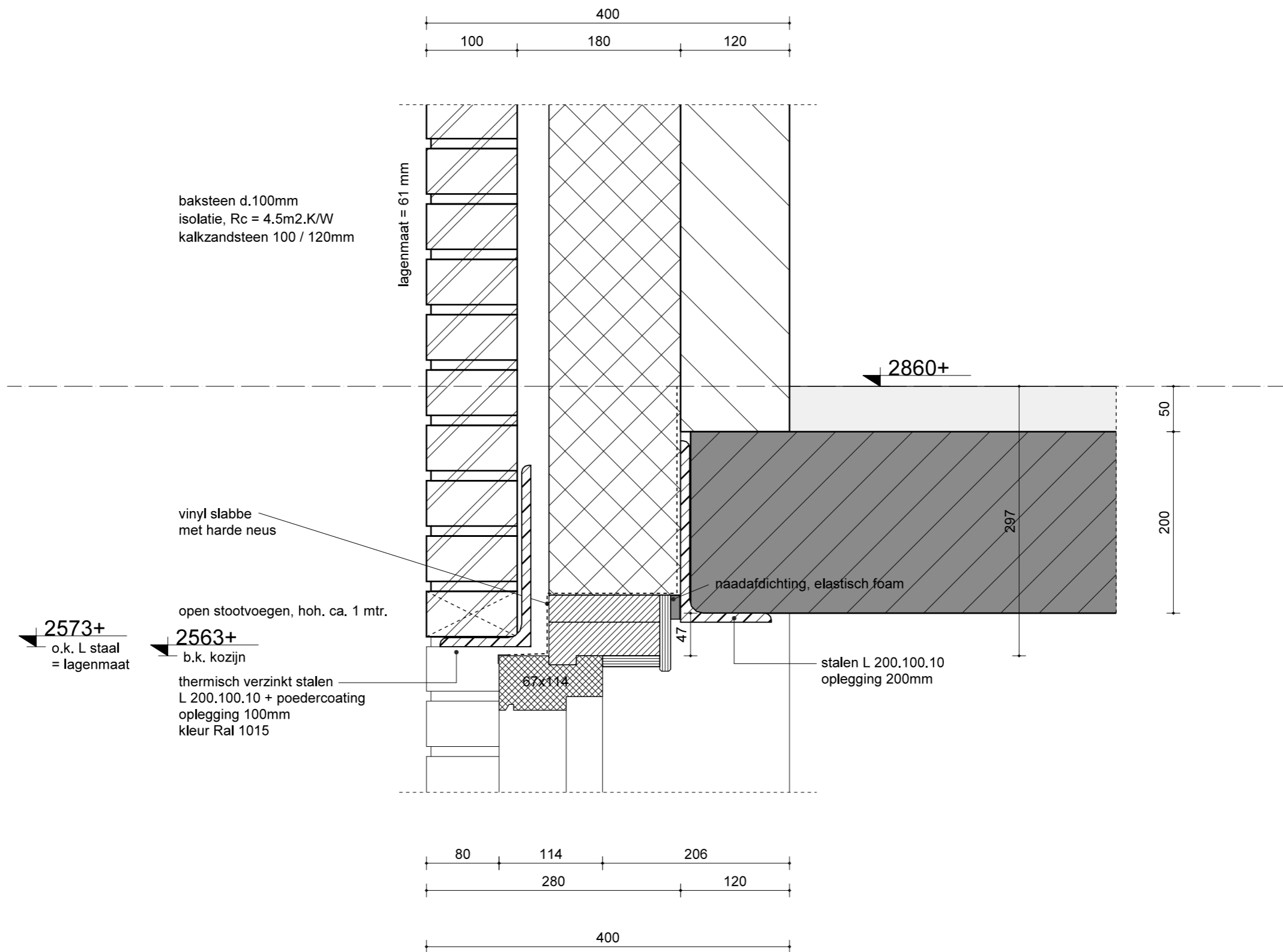

detail 7

keramische dakpannen
fabr. Monier, model
prefab zelfdragende kapconstructie
Rc = 6,0 m2.K/W

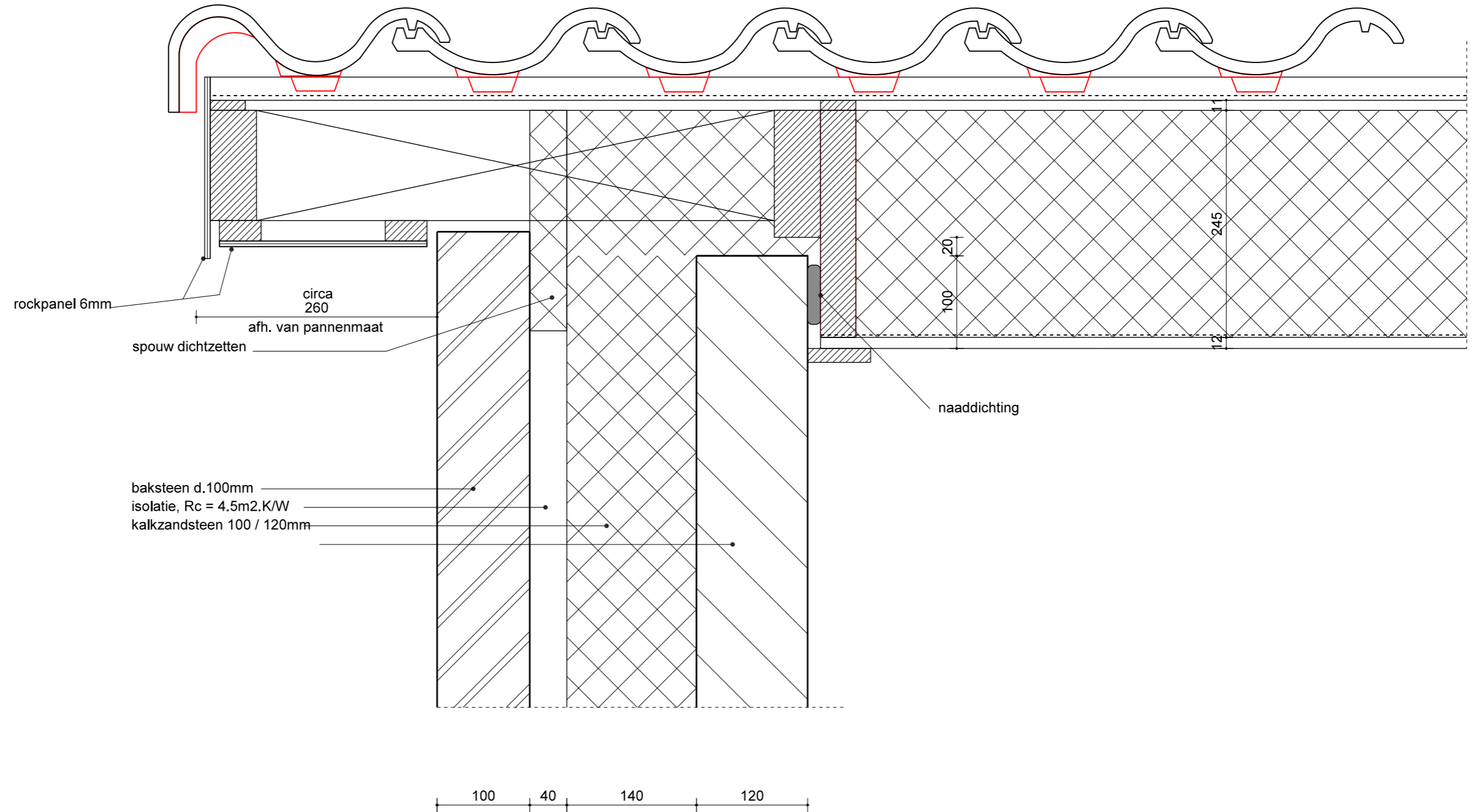

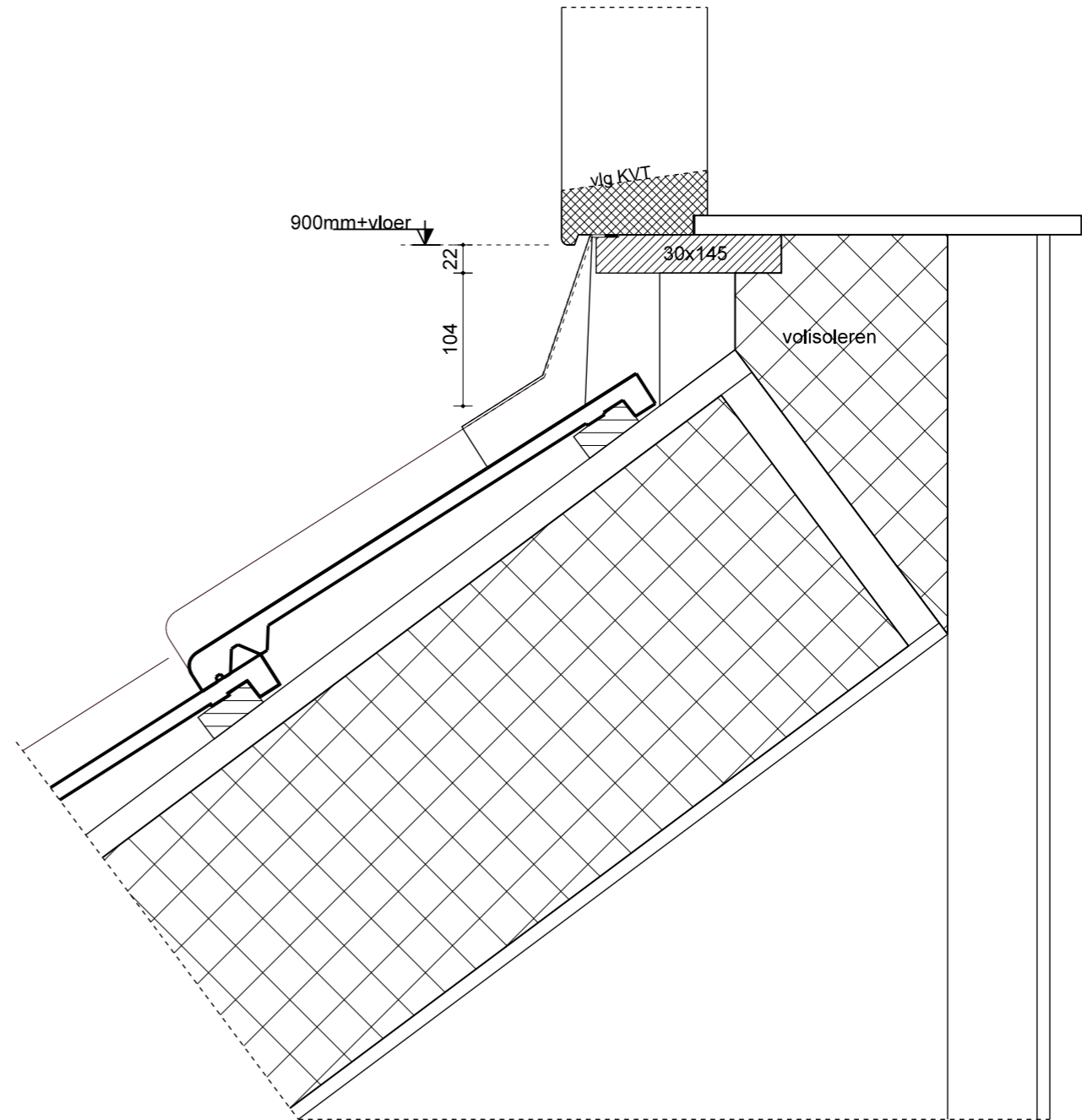
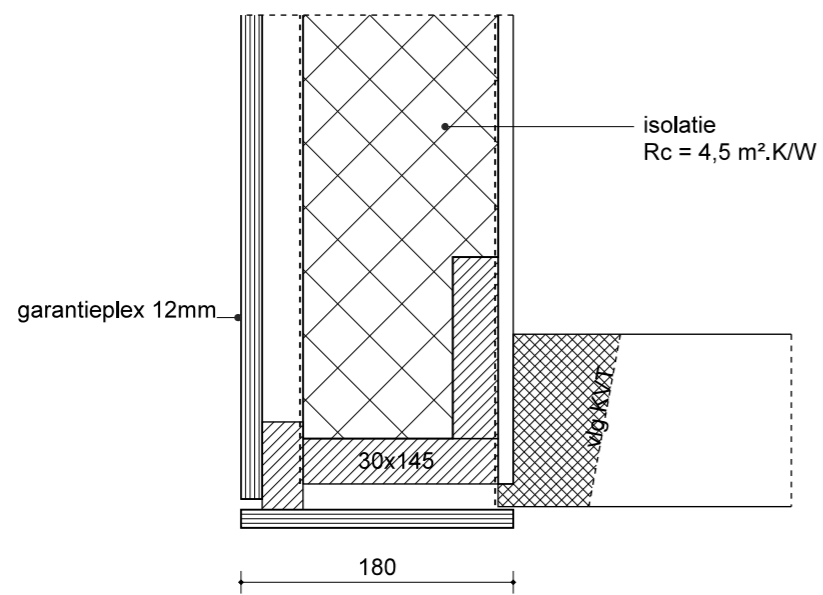
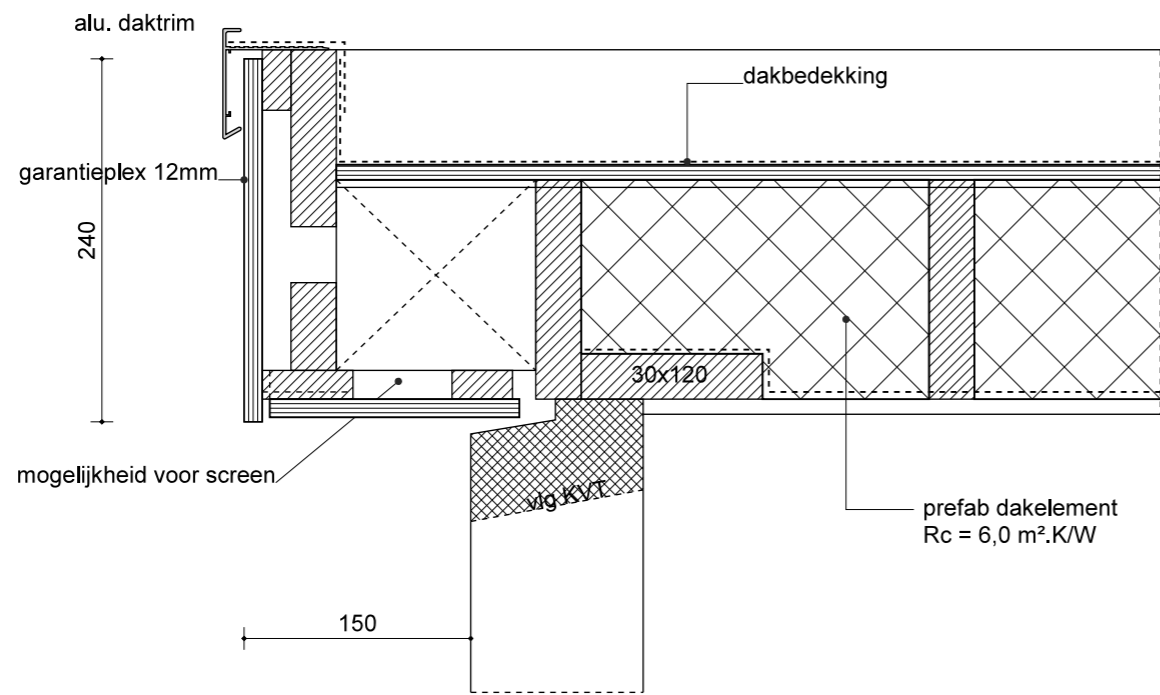

principe details dakkapel

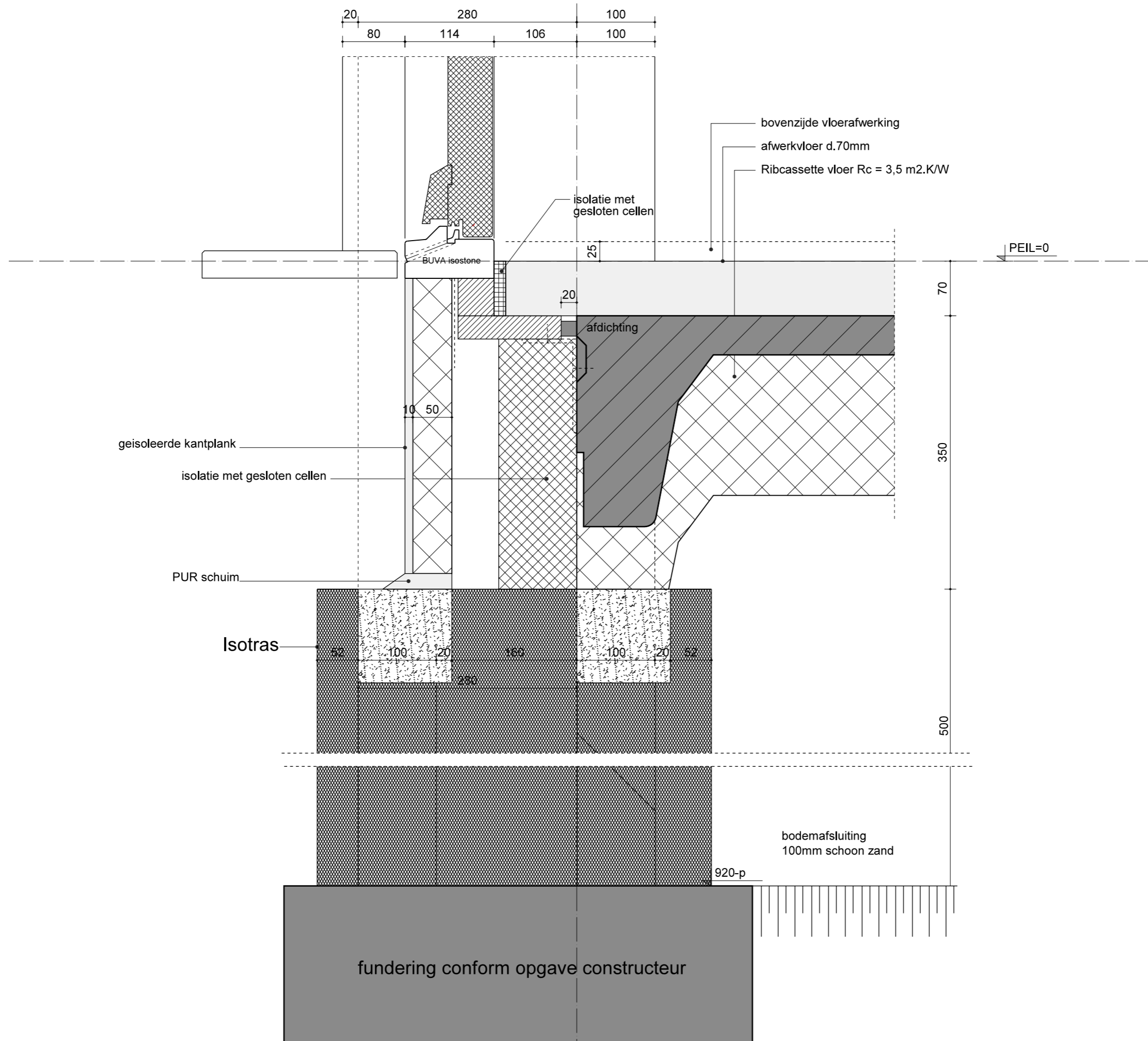

detail 9

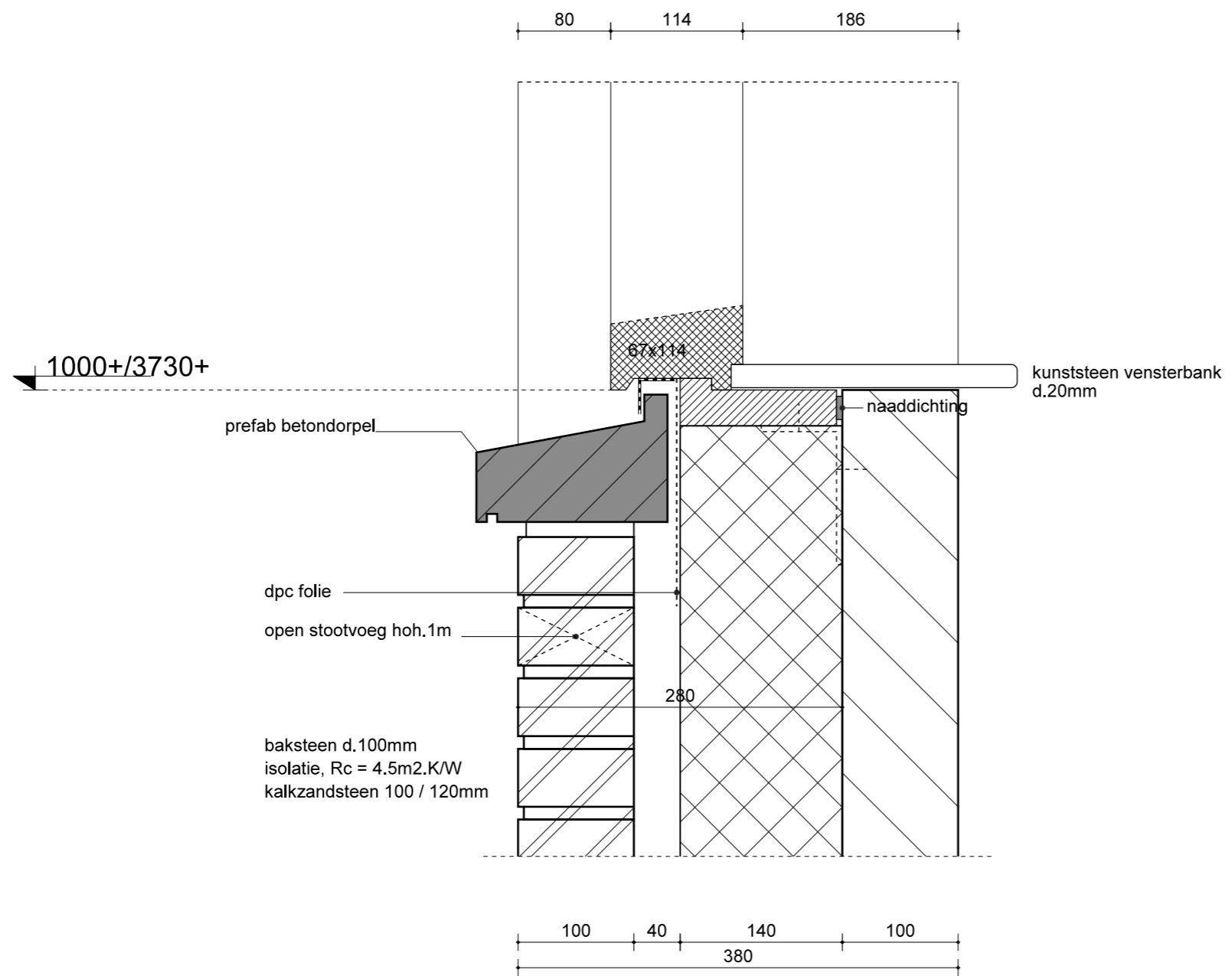

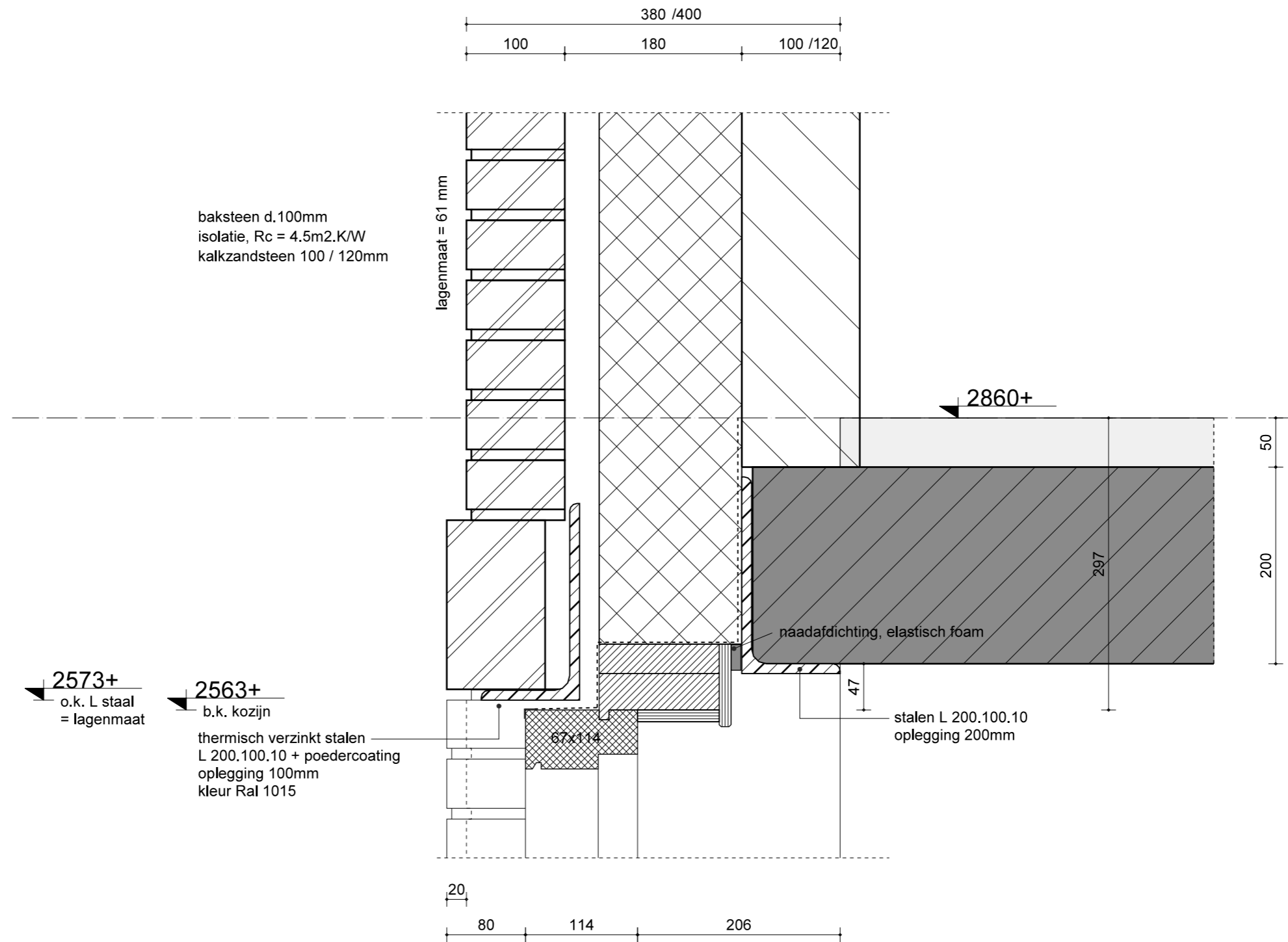

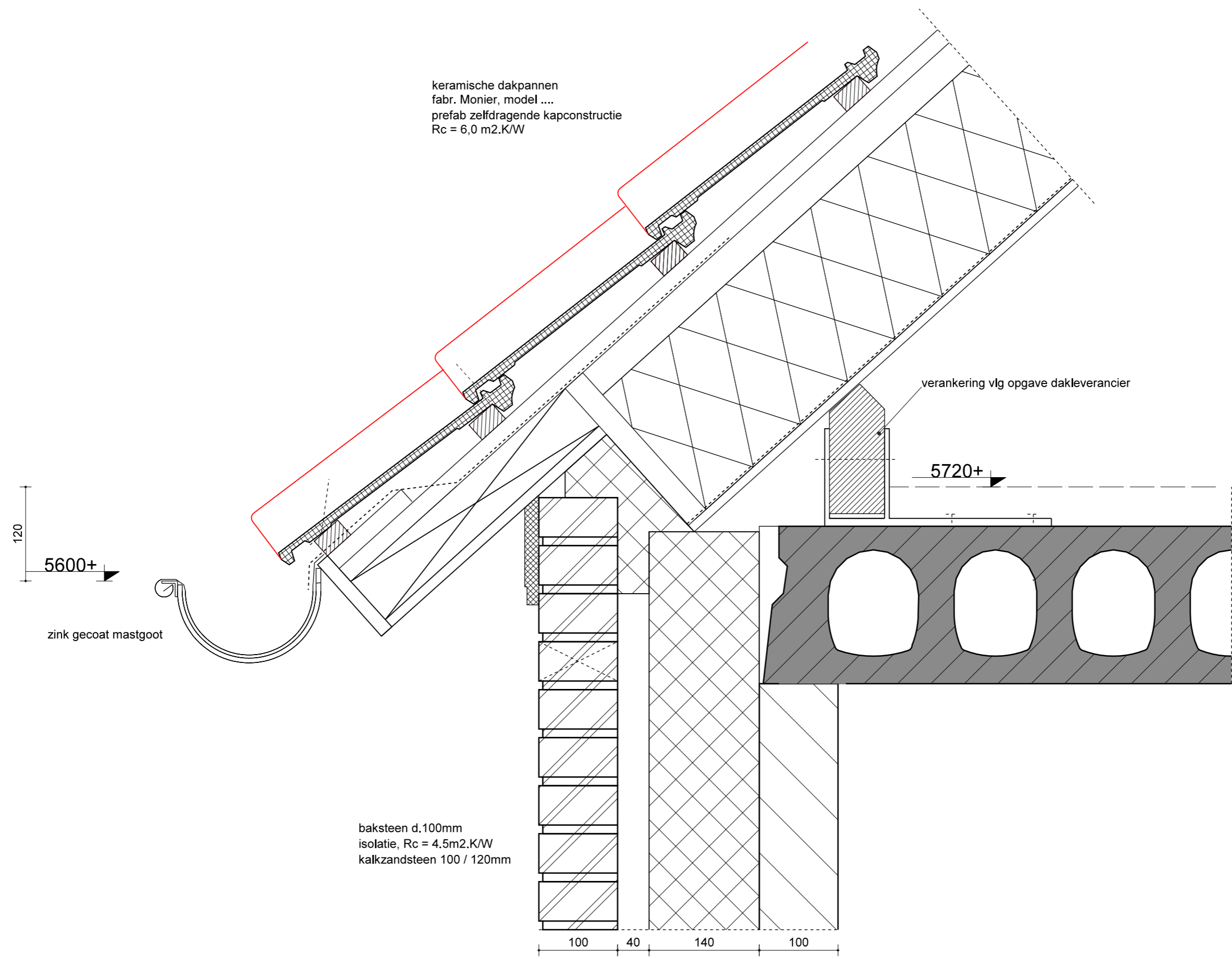

keramische dakpannen
 fabr. Monier, model
 prefab zelfdragende kapconstructie
 Rc = 6,0 m2.K/W

verankering vlg opgave dakleverancier

120
 5600+

zink gecoat mastgoot

5720+

baksteen d.100mm
 isolatie, Rc = 4.5m2.K/W
 kalkzandsteen 100 / 120mm

100 40 140 100

keramische dakpannen
fabr. Monier, model
prefab zelfdragende kapconstructie
Rc = 6,0 m2.K/W

120
5600+
zink gecoat mastgoot
270
5330+

verankering vlg opgave dakleverancier

5720+

390

80 114 86 100
280 100

detail 13

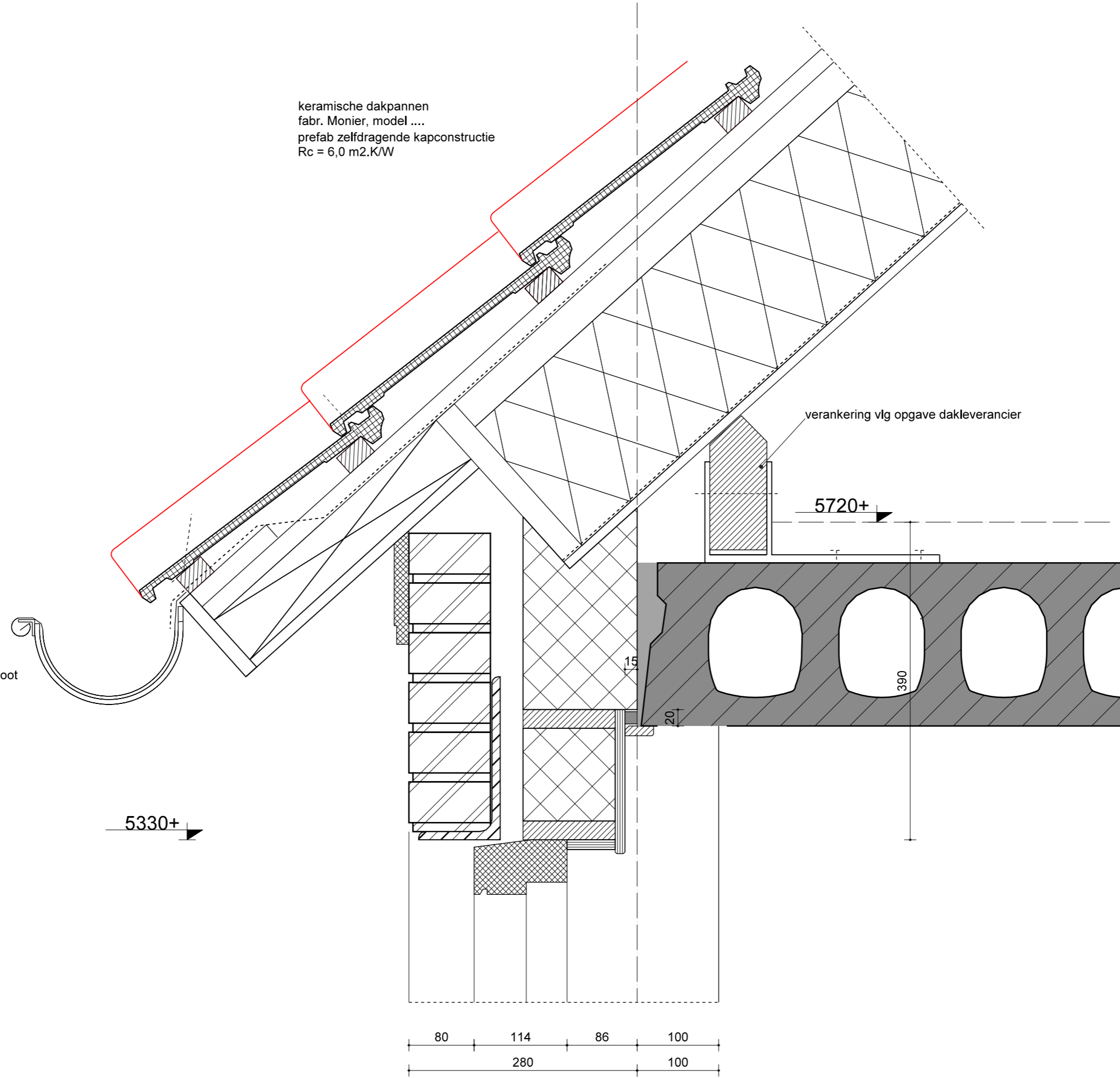

keramische dakpannen
fabr. Monier, model ...
prefab zelfdragende kapconstructie
Rc = 6,0 m².K/W

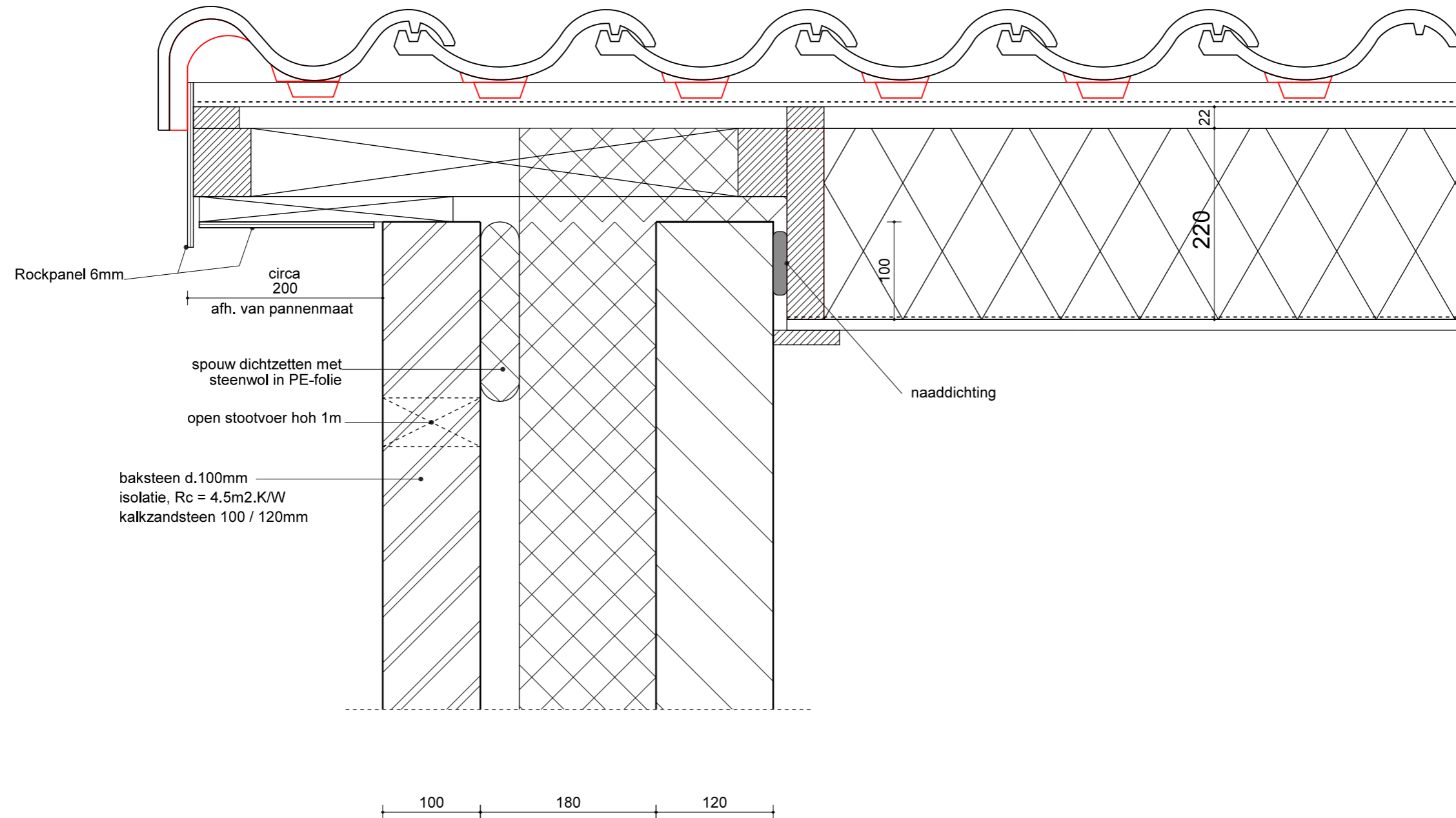

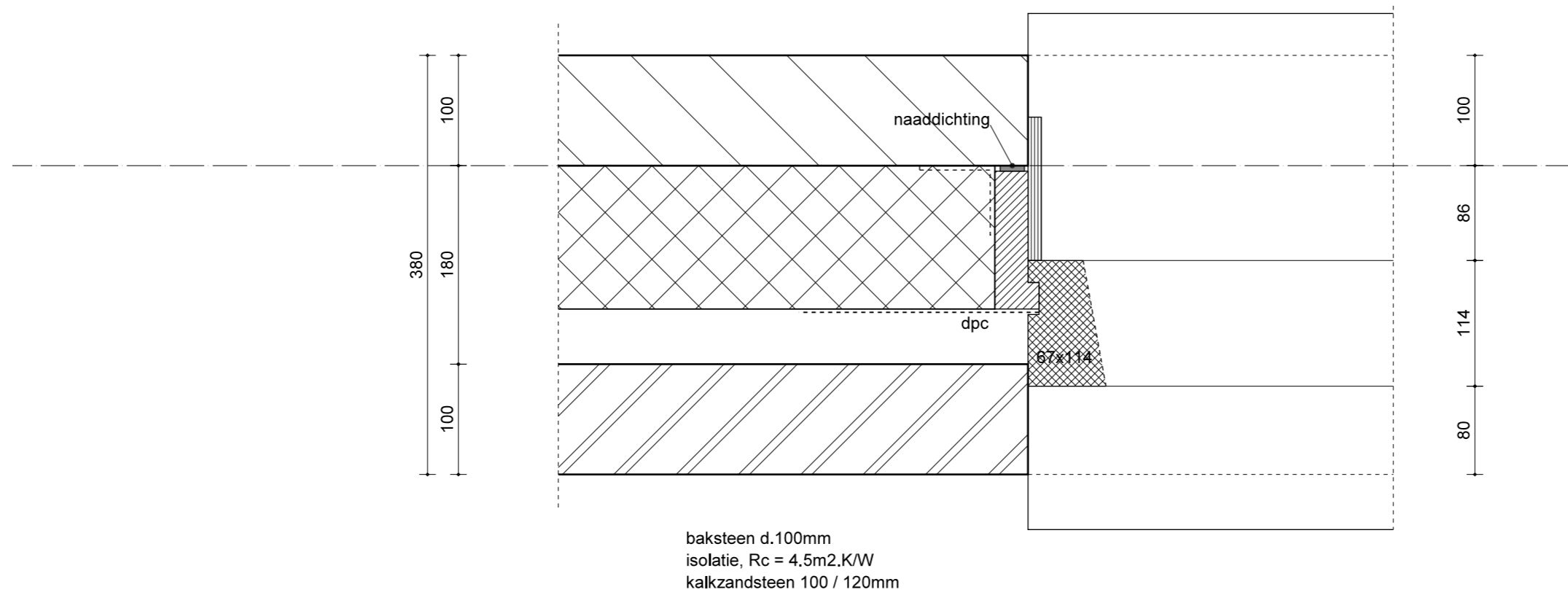

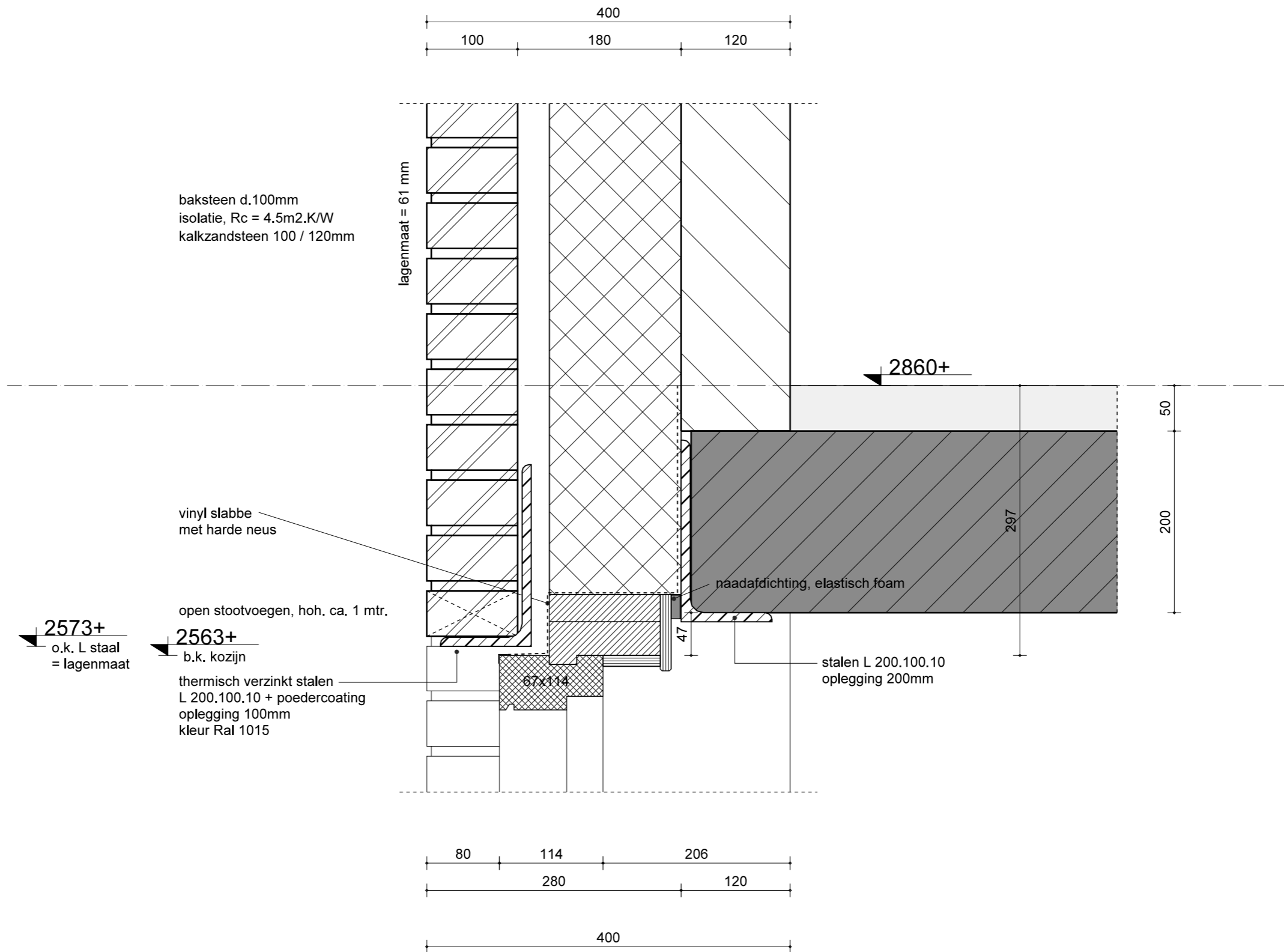

detail 16

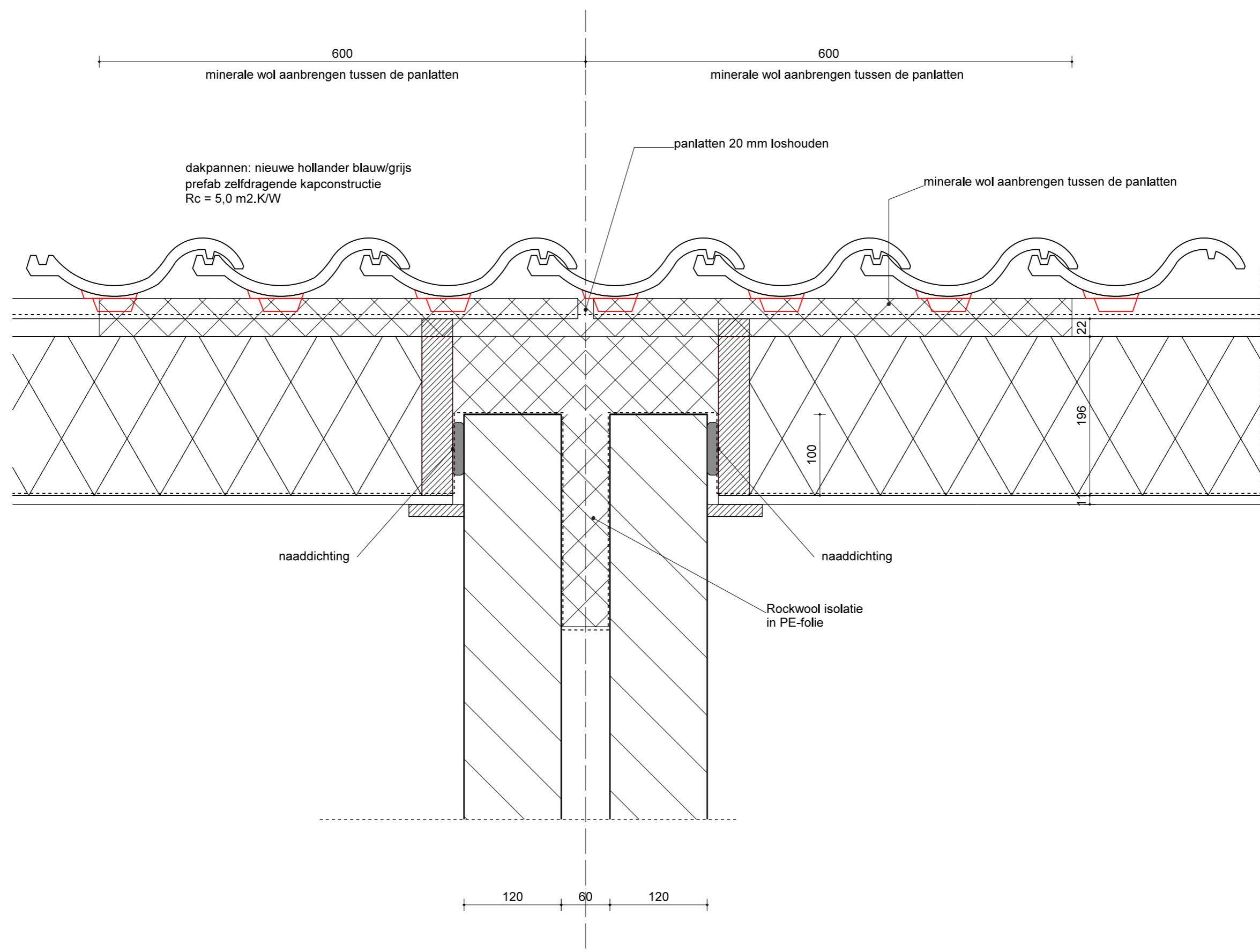

detail 17

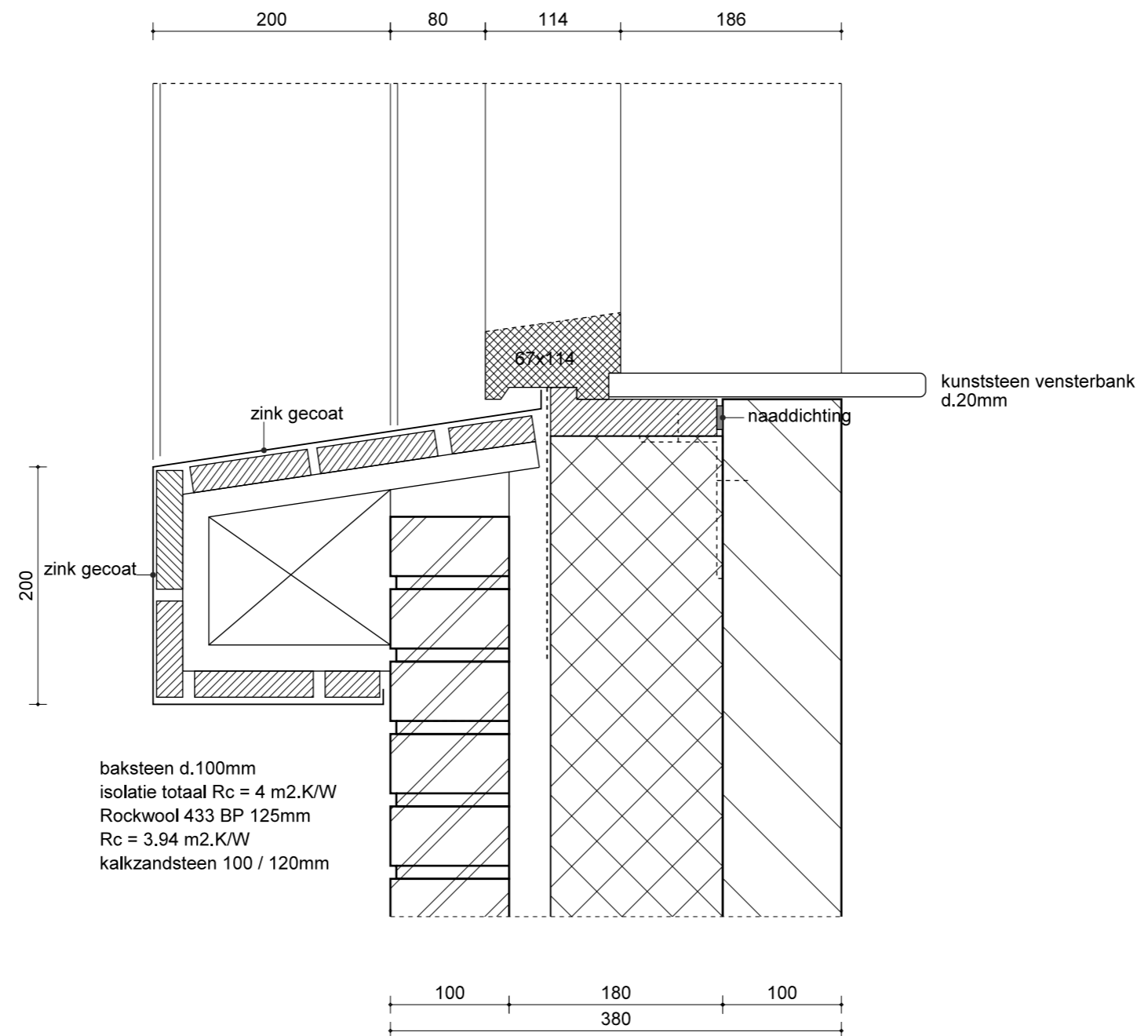

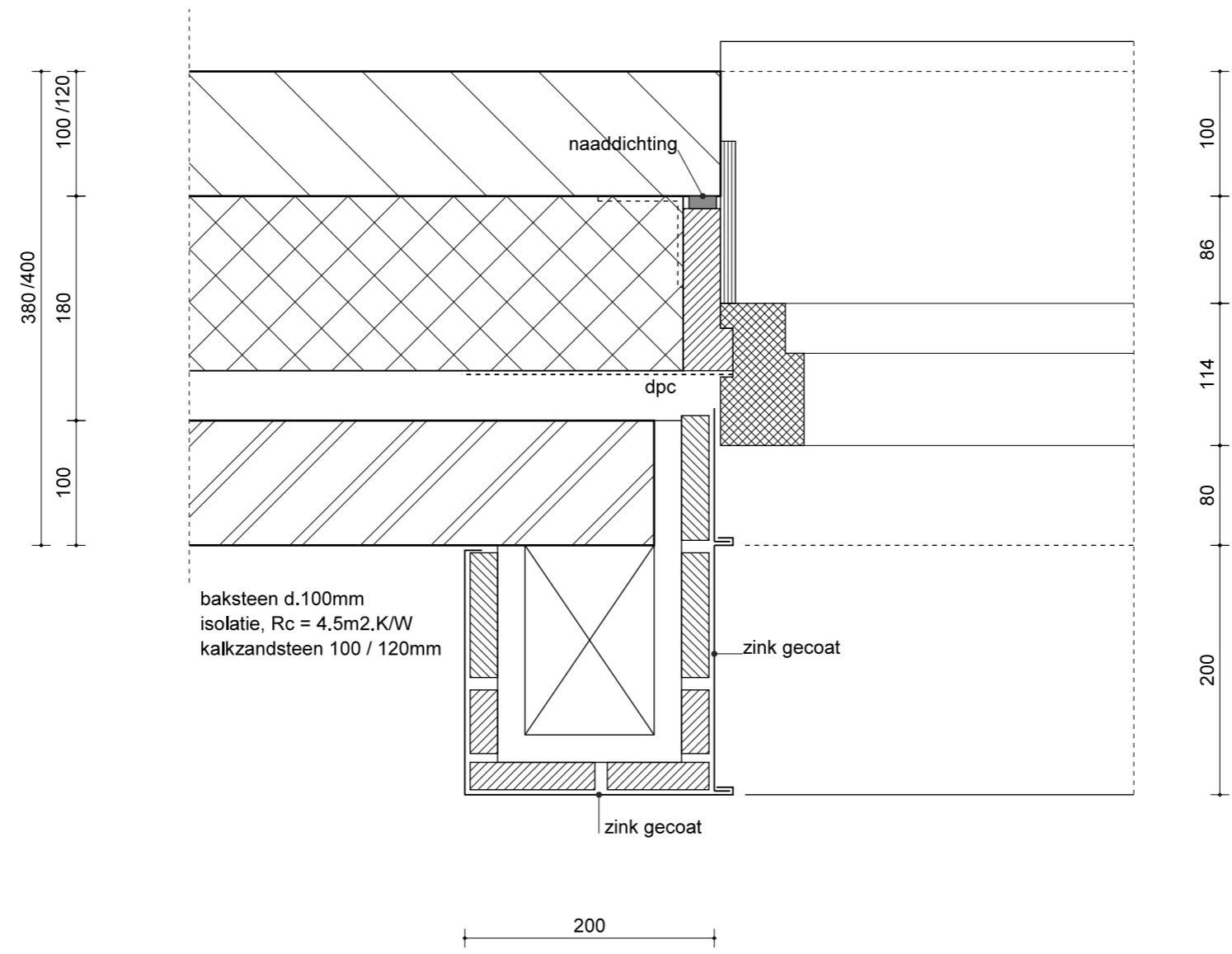

detail 19

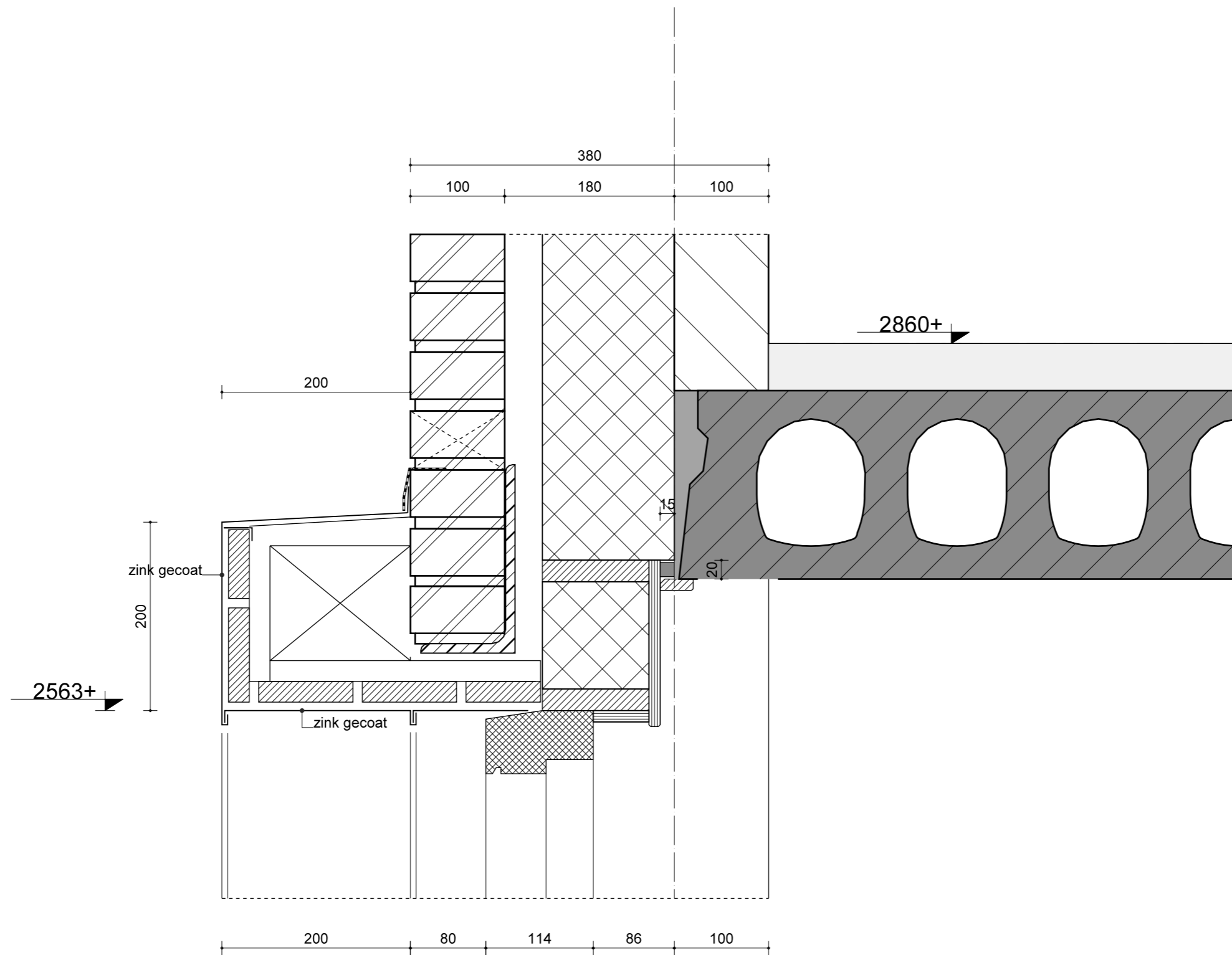

detail 20

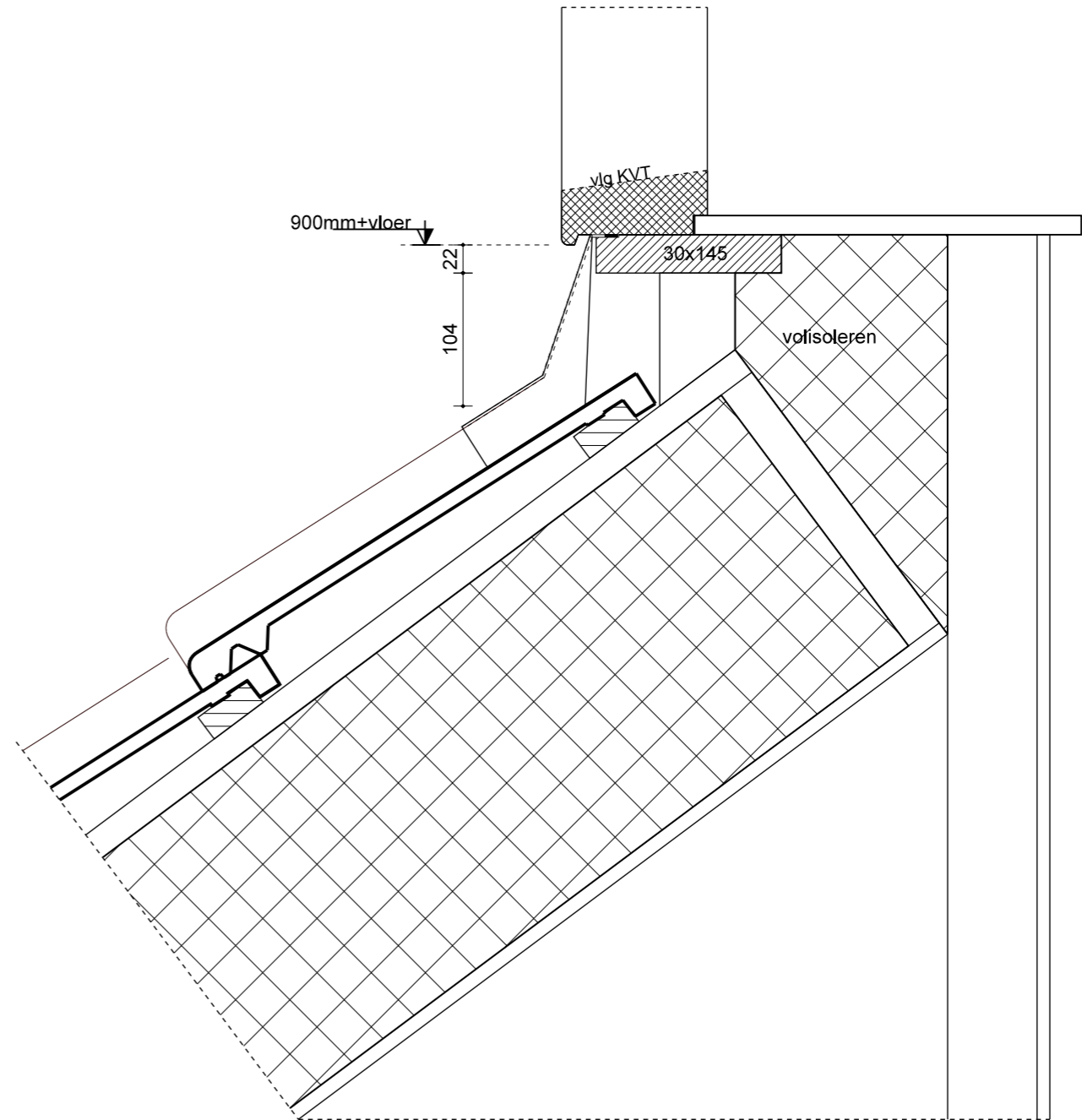
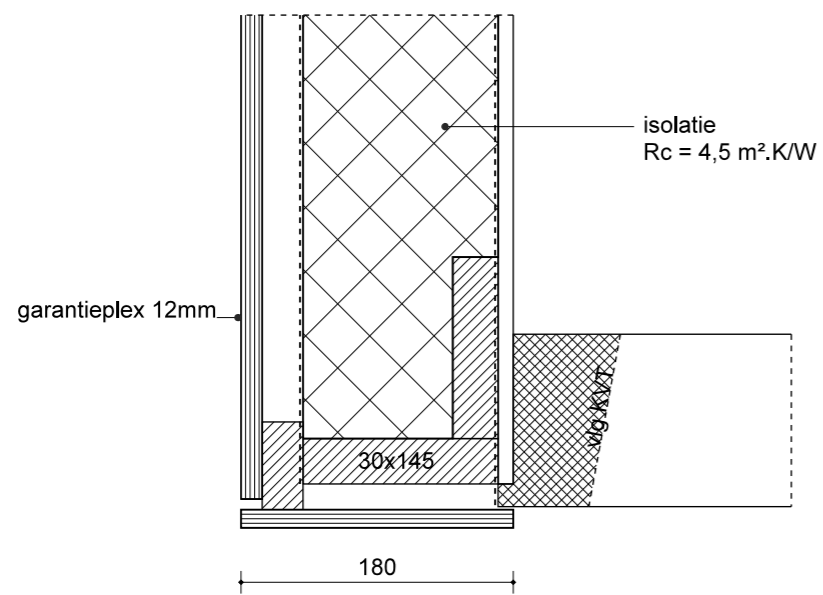
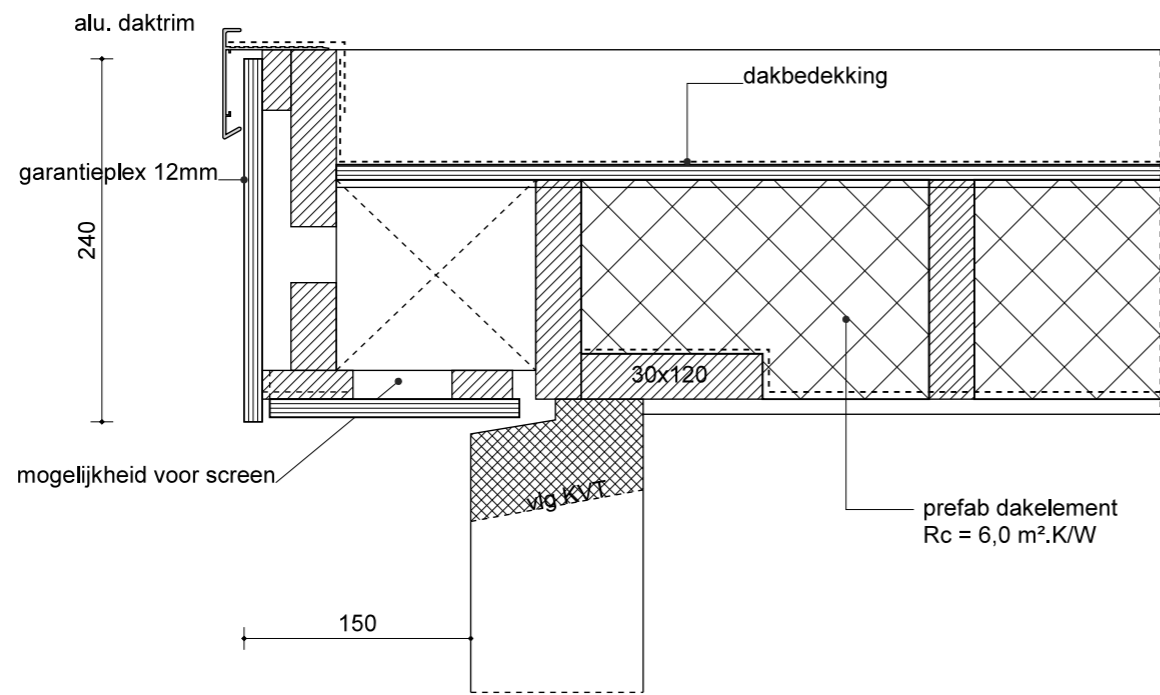

principe details dakkapel

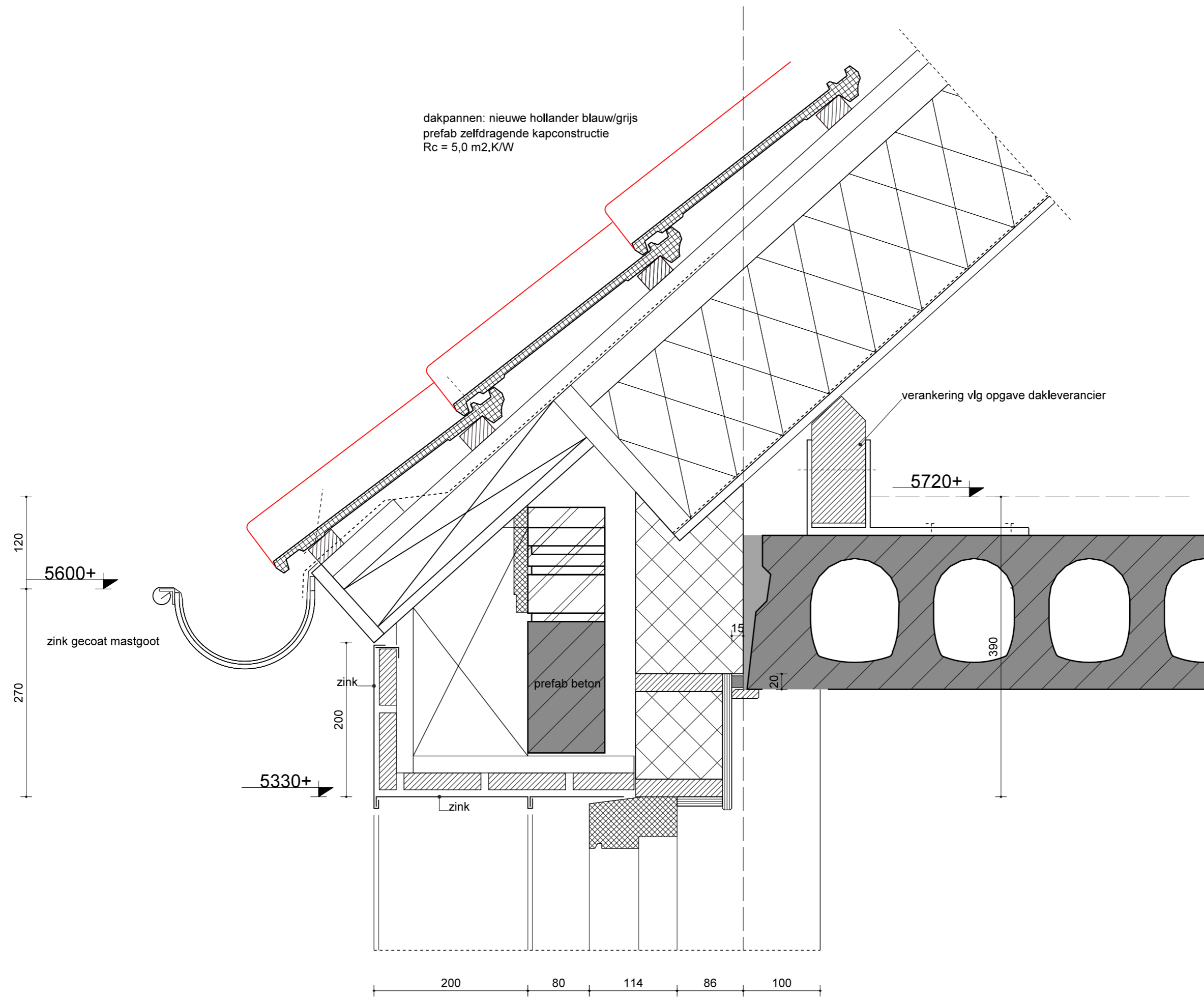

dakpannen: nieuwe hollander blauw/grijs
 prefab zelfdragende kapconstructie
 $R_c = 5,0 \text{ m}^2\cdot\text{K/W}$

verankering vlg opgave dakleverancier

5600+

zink gecoat mastgoot

120

270

5330+

zink

200

prefab beton

zink

5720+

390

200

80

114

86

100

detail 21

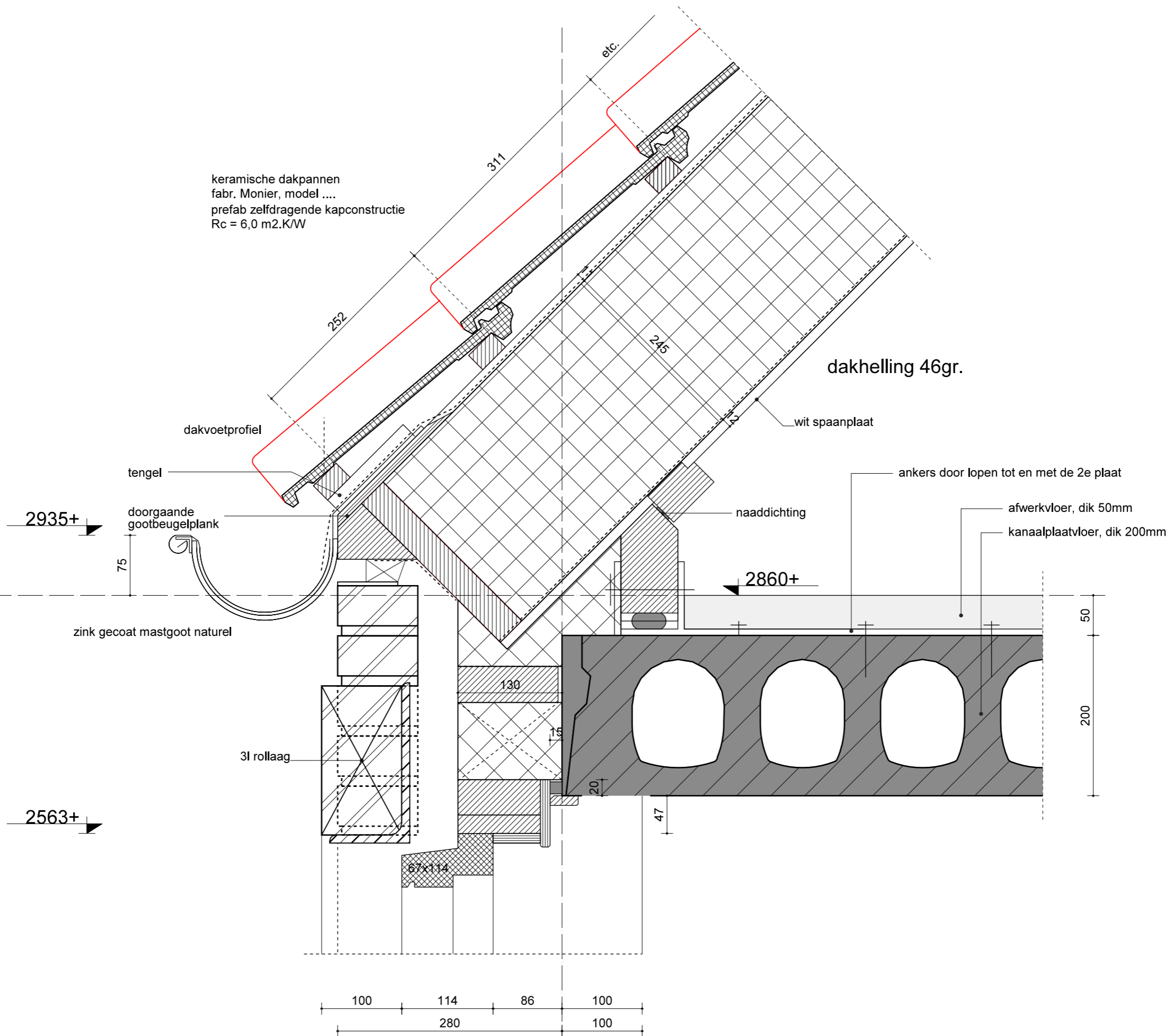

detail 22

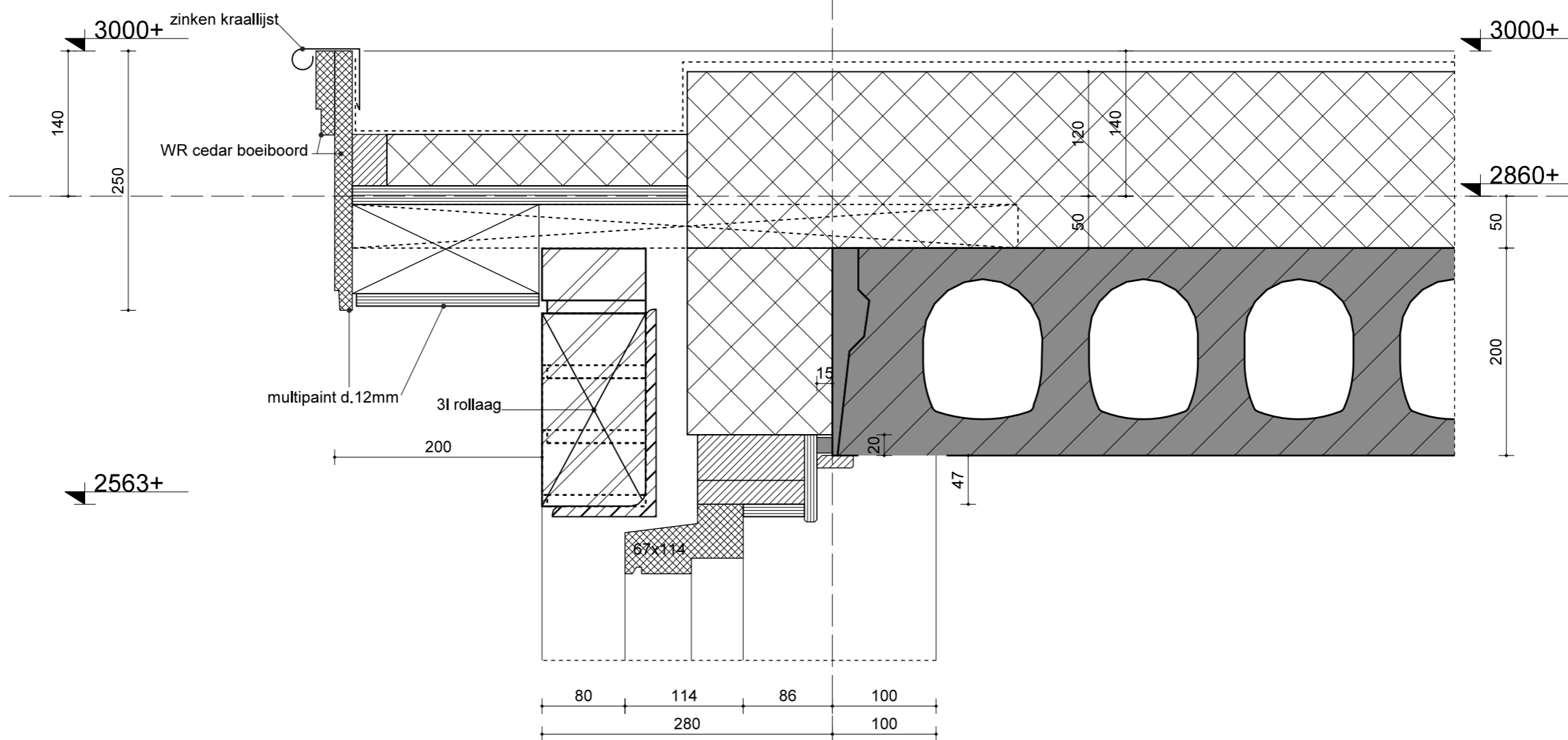

3000+

140

250

2563+

zinken kraallijst

WR cedar boeiboord

multipaint d.12mm

3l rollaag

200

80 114 86 100

280 100

3000+

2860+

50

200

detail 23

