

- Verklaring:**
- Duiker
  - Uitstroombuis
    - CC075 CC075 1/m CC075, CC079 1/m CC079 en CC083 1/m CC083 conform detail 1
    - CC084 conform detail 2
    - CC082 conform detail 3
  - Inspectieput van beton
  - Doorsteek bermslagings Maaiveld ca 50 mm lager aanbrengen dan omgeving
  - Aanbrengen verlaagde berm
  - Oligraven waterpartij/waiergang
  - Bestaande waiergang, te handhaven
  - Dempen waiergang

OPDRACHTGEVER	TEREENAAR	SCHAAL
Gemeente Tilburg	DCr	1:200
PROJECTLEIDER	FORMAAT	
Falkgoud Spoorlijn Eindhoven	A0	
TEKENINGENOMMER	BLAD IN RIJEN	
180262	1 van 2	
TEKENINGENOMMER	WIJZ AN	
180262	1	
TEKENINGENOMMER	WIJZ AN	
180262	1	
TEKENINGENOMMER	WIJZ AN	
180262	1	

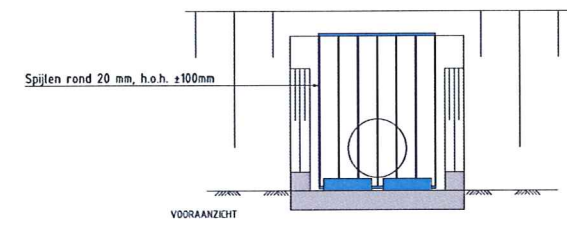

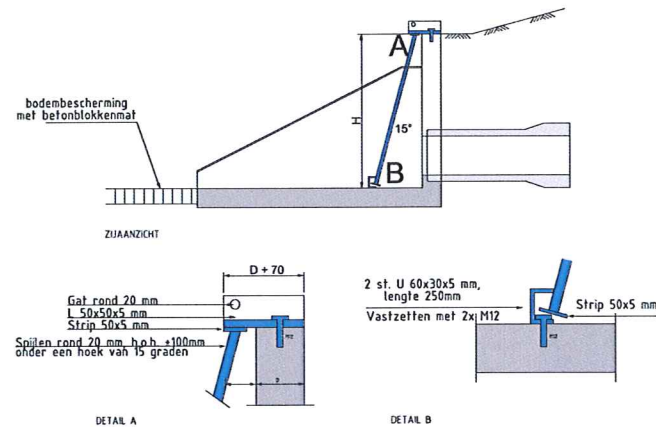



Alle verbindingen gelast en alle materialen van thermisch verzinkt staal (80 micron);  
Alle genoemde maten zijn in mm;

**Detail 1 Taludbak met Spijlenrooster**  
Schaal 1:50

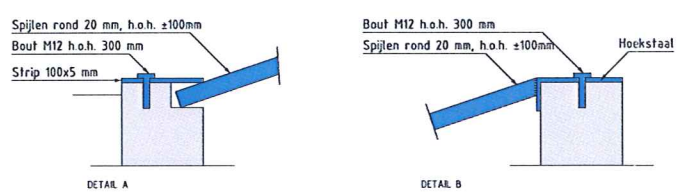
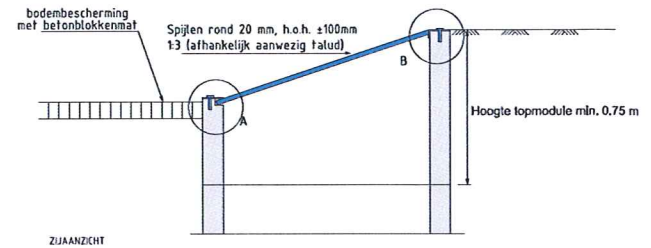

**Detail 2 Taludbak met Spijlenrooster**  
Schaal 1:50

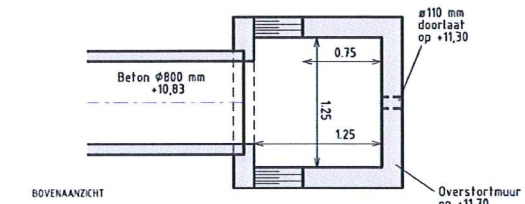
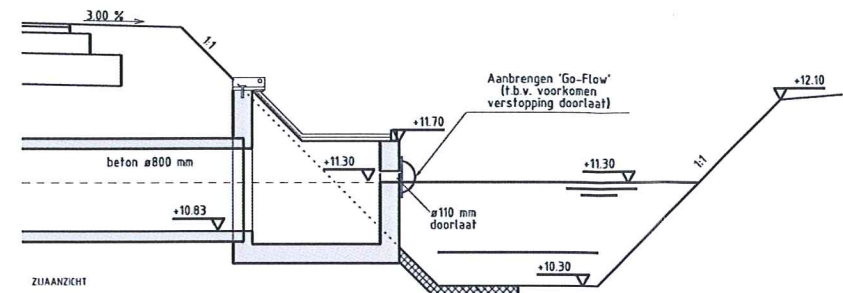

**Detail 3 Stuwput met Spijlenrooster**  
Schaal 1:50

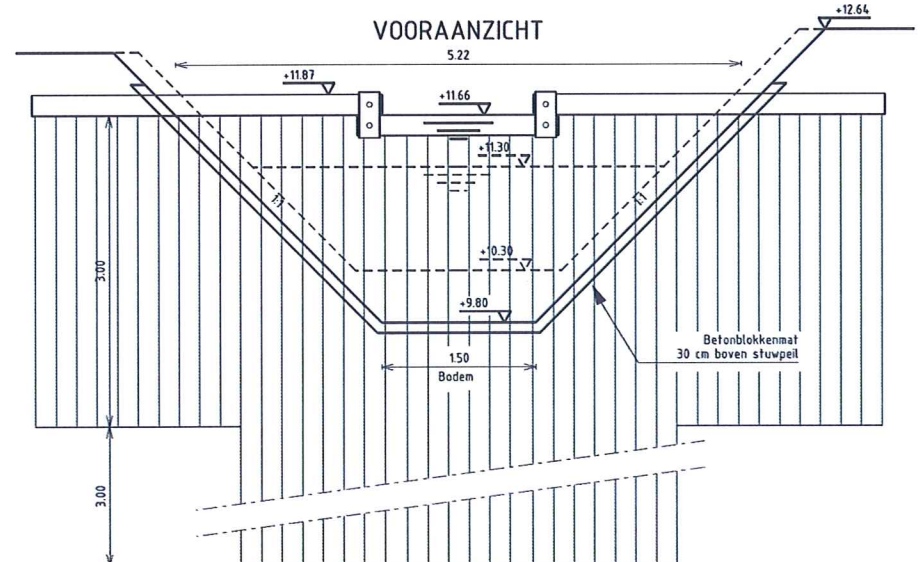

**Detail 4: Vervangen 'bestaande stuw'**  
Schaal 1:50

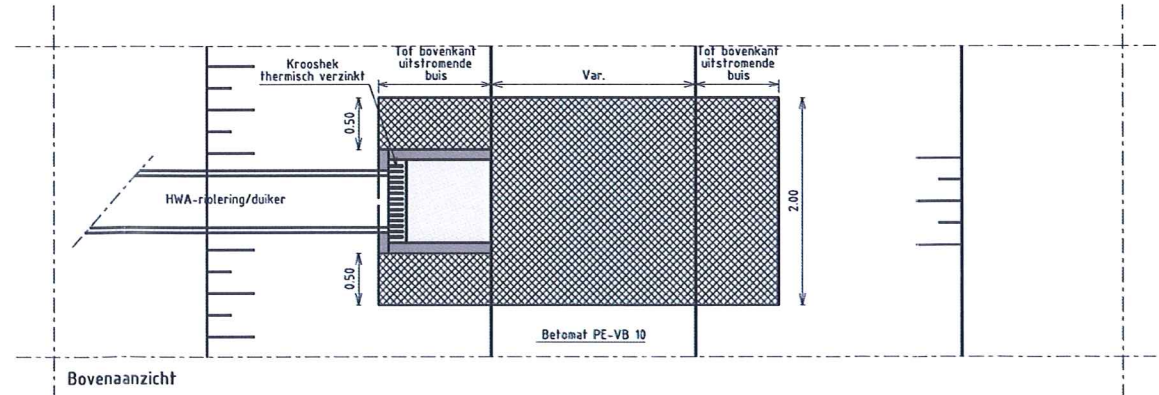

**Detail 5: Principe bodembescherming (m.u.v. detail 9, locatie stuwput)**  
Schaal 1:50

<b>OPDRACHTGEVER</b> Gemeente Tilburg	<b>TEKENAAR</b> DCr	<b>SCHAAL</b> 1:200
<b>PROJECTOMSCHRIJVING</b> Fietspad Sportlane Eindhoveneseweg	<b>PROJECTLEIDER</b> DRa	<b>FORMAAT</b> A0
<b>TEKENINGOMSCHRIJVING</b> Watervergunning	<b>TEKENINGNUMMER</b> 180263	<b>BLAD IN BLADEN</b> 2 IN 2
<b>DOCUMENTSOORT</b> TEKENING	<b>STATUS</b> Definitief	<b>WIJZ.NR</b> 1
Rasenberg INFRA Rat Verlegstraat 120 4800 CE, BREDA		Postbus 2238 076 5 781 200 076 5 781 218
Onderdeel van: 		