

Nulpunt 3.75 +NAP

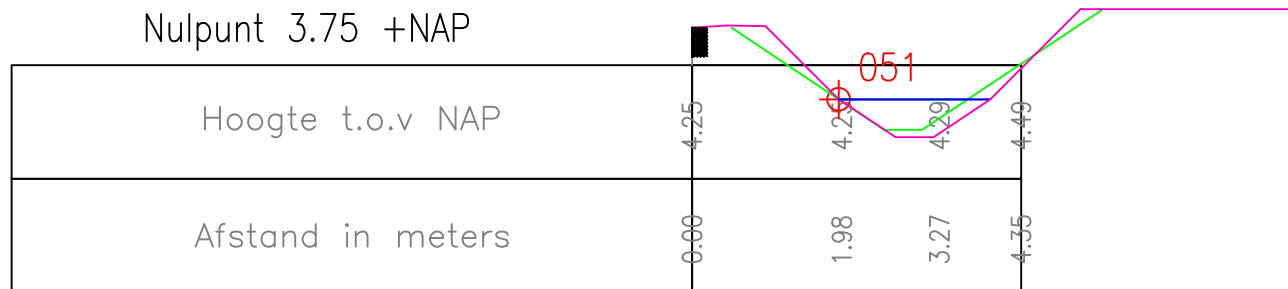

Oprachtgever		 HOOGHEEMRAADSCHAP DE STICHTSE RIJNLANDEN		Postbus 550 3990 GJ Houten		Poldermolen 2 3994 DD Houten	
				Tel.: (030) 634 57 00		e-mail: post@hdsr.nl	
				Fax: (030) 634 59 98		www.destichtserijnlanden.nl	
Project							
Herprofilering Gooyerwetering							
Onderdeel							
ontwerp-profiel							
Projectnr.		Besteknr(s).		Documentnr.		Status	
401024						concept	
Formaat	Schaal	Getek.	Datum	Goedgek.	Akk.	Tek.nr.	Versie
A4	1:100	D.S.	8-4-2015			51	1

Nulpunt 3.75 +NAP

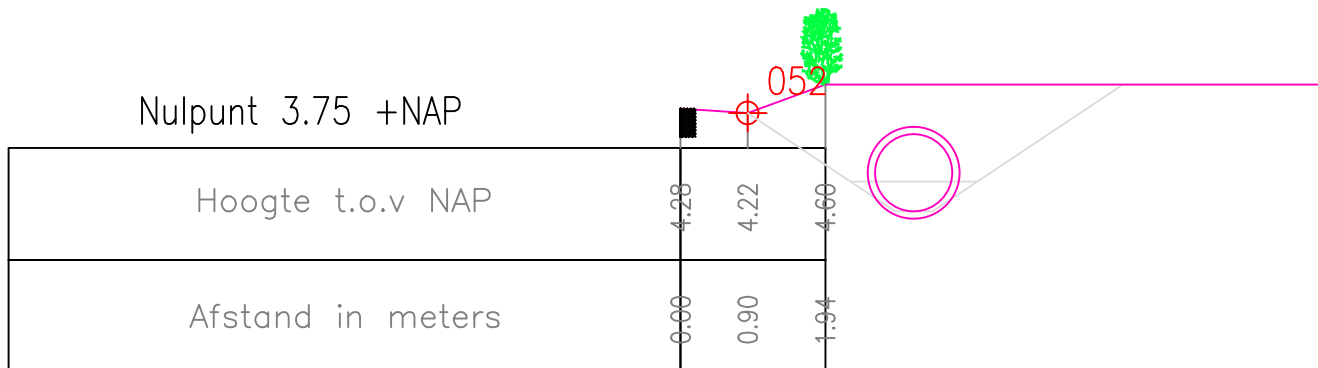

Oprachtgever			HOOGHEEMRAADSCHAP DE STICHTSE RIJNLANDEN		Postbus 550 3990 GJ Houten	Poldermolen 2 3994 DD Houten							
Project			Herprofilering Gooyerwetering										
Onderdeel		ontwerp-profiel				Tel.: (030) 634 57 00 Fax: (030) 634 59 98		e-mail: post@hdsr.nl www.destichtserijnlanden.nl					
Projectnr.	401024	Besteknr(s).		Documentnr.	Status			concept					
Formaat	A4	Schaal	1:100	Getek.	D.S.	Datum	8-4-2015	Goedgek.	Akk.	Tek.nr.	52	Versie	1

Nulpunt 2.75 +NAP

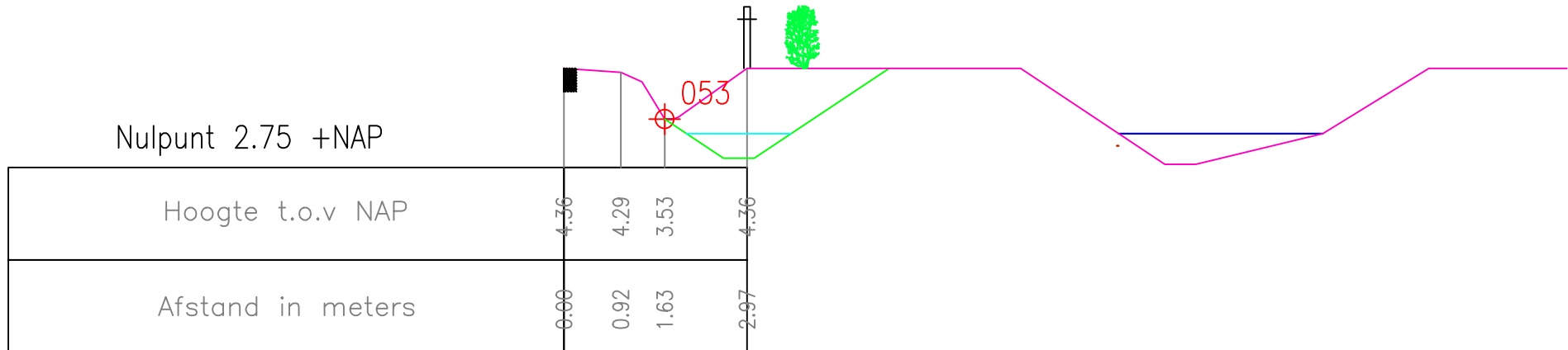

Opdrachtgever		 HOOGHEEMRAADSCHAP DE STICHTSE RIJNLANDEN	Postbus 550 3990 GJ Houten	Poldermolen 2 3994 DD Houten
Project			Tel.: (030) 634 57 00 Fax: (030) 634 59 98	e-mail: post@hdsr.nl www.destichtserijnlanden.nl
Herprofilering Gooyerwetering Onderdeel ontwerp-profiel				
Projectnr.	401024	Besteknr(s).	Documentnr.	Status concept
Formaat A4	Schaal 1:100	Getek. D.S.	Datum 8-4-2015	Goedgek. Akk. Tek.nr. 53
				Versie 1

Nulpunt 2.75 +NAP

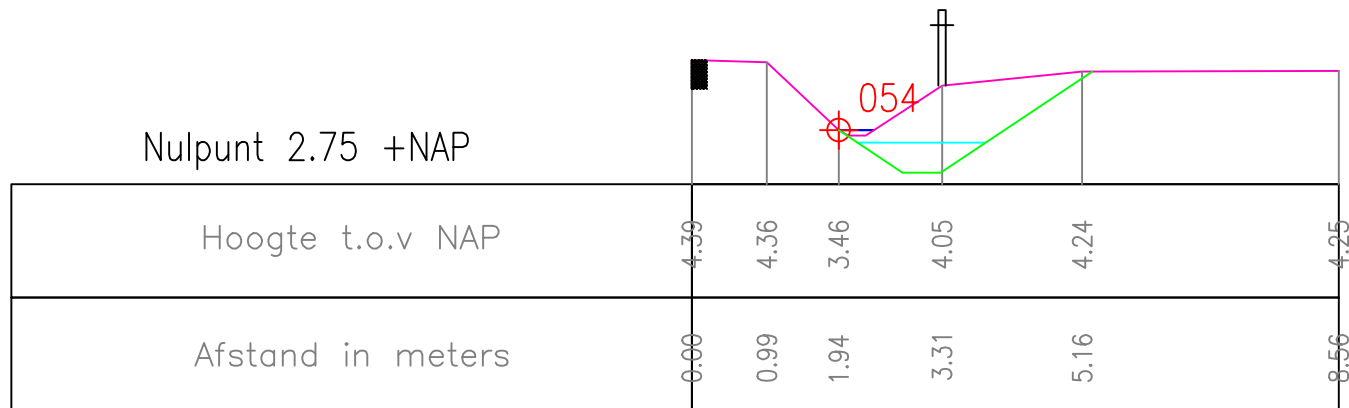

Oprachtgever



HOOGHEEMRAADSCHAP
DE STICHTSE
RIJNLANDEN

Postbus 550
3990 GJ Houten

Poldermolen 2
3994 DD Houten

Tel.: (030) 634 57 00
Fax: (030) 634 59 98

e-mail: post@hdsr.nl
www.destichtserijnlanden.nl

Project

Herprofilering Gooyerwetering

Onderdeel

ontwerp-profiel

Projectnr.

401024

Besteknr(s).

Documentnr.

Status

concept

Formaat

A4

Schaal

1:100

Getek.

D.S.

Datum

8-4-2015

Goedgek.

Akk.

Tek.nr.

54

Versie

1

Nulpunt 2.75 +NAP

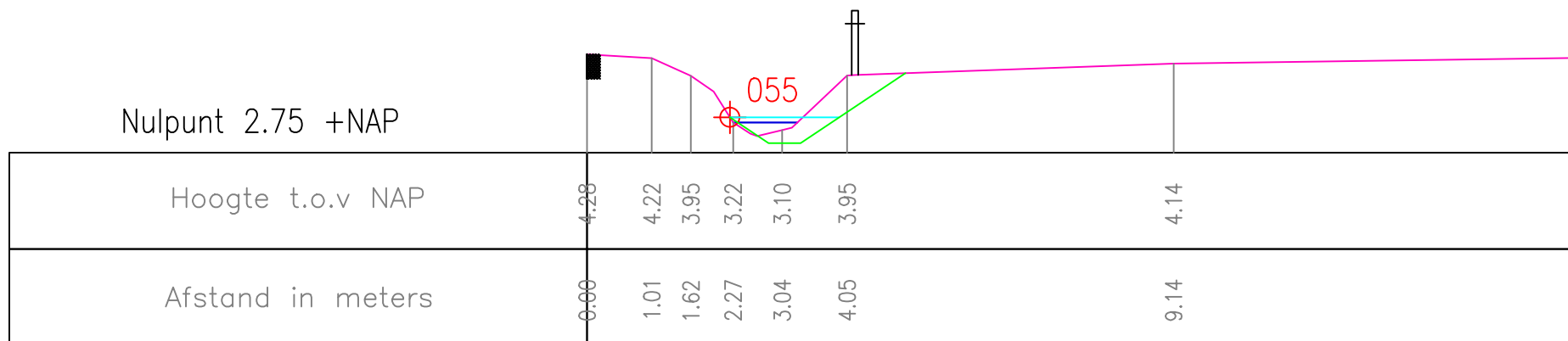

Oprachtgever		 HOOGHEEMRAADSCHAP DE STICHTSE RIJNLANDEN	Postbus 550 3990 GJ Houten	Poldermolen 2 3994 DD Houten									
Project			Tel.: (030) 634 57 00 Fax: (030) 634 59 98	e-mail: post@hdsr.nl www.destichtserijnlanden.nl									
Herprofilering Gooyerwetering Onderdeel ontwerp-profiel													
Projectnr.	401024	Besteknr(s).	Documentnr.	Status concept									
Formaat	A4	Schaal	1:100	Getek.	D.S.	Datum	8-4-2015	Goedgek.	Akk.	Tek.nr.	55	Versie	1

Nulpunt 1.75 +NAP

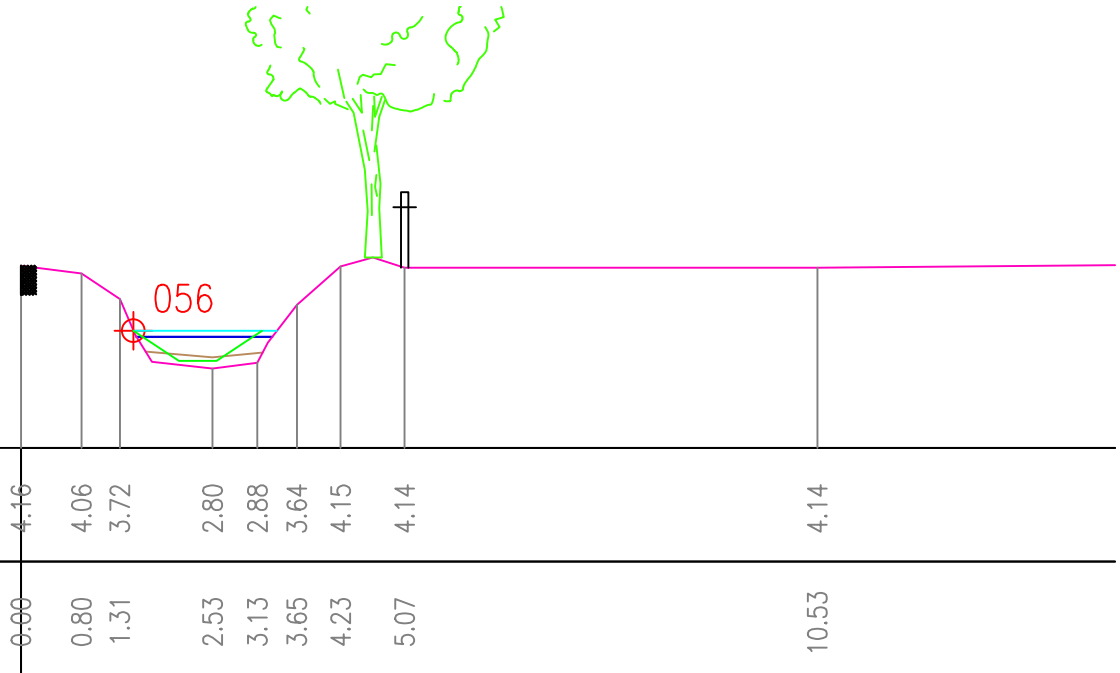

Opdrachtgever		 HOOGHEEMRAADSCHAP DE STICHTSE RIJNLANDEN		Postbus 550 3990 GJ Houten		Poldermolen 2 3994 DD Houten	
Project		Herprofilering Gooyerwetering					
Onderdeel		ontwerp-profiel					
Projectnr.	401024	Besteknr(s).		Documentnr.		Status	concept
Formaat	A4	Schaal	1:100	Getek.	D.S.	Datum	8-4-2015
		Goedgek.		Akk.		Tek.nr.	56
						Versie	1

Nulpunt 1.75 +NAP

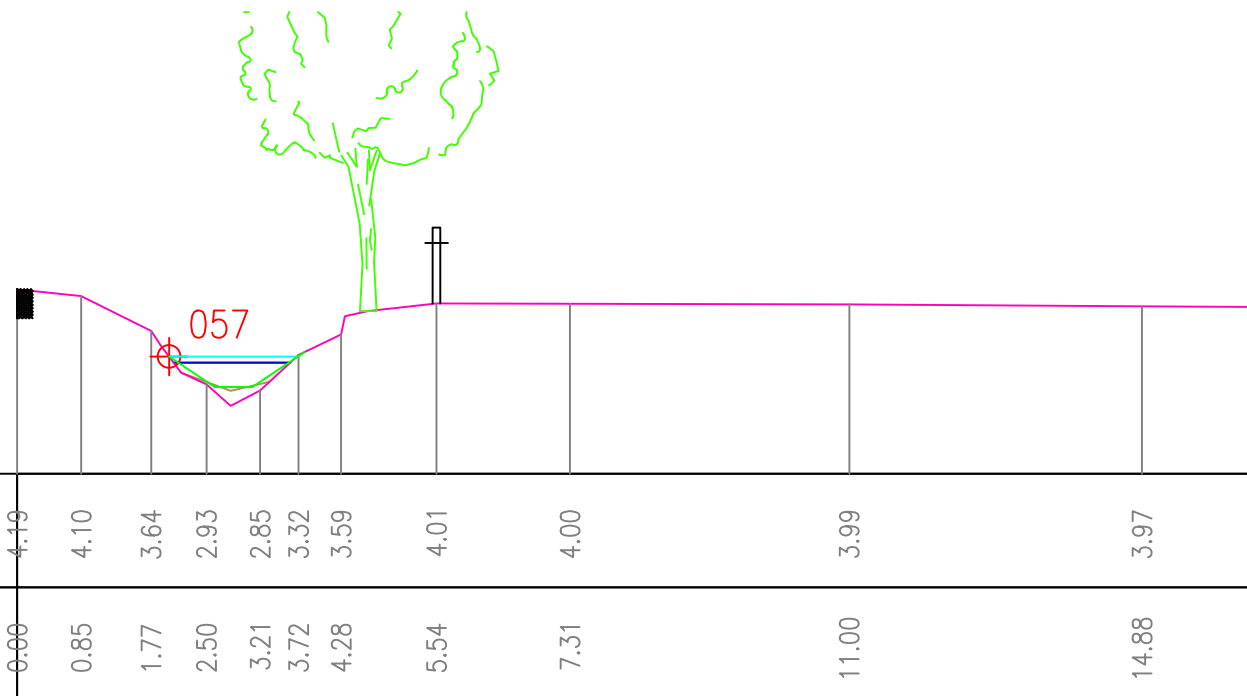

Oprachtgever		 HOOGHEEMRAADSCHAP DE STICHTSE RIJNLANDEN	Postbus 550 3990 GJ Houten	Poldermolen 2 3994 DD Houten									
Project			Tel.: (030) 634 57 00 Fax: (030) 634 59 98	e-mail: post@hdsr.nl www.destichtserijnlanden.nl									
Herprofilering Gooyerwetering Onderdeel ontwerp-profiel													
Projectnr.	401024	Besteknr(s).	Documentnr.	Status concept									
Formaat	A4	Schaal	1:100	Getek.	D.S.	Datum	8-4-2015	Goedgek.	Akk.	Tek.nr.	57	Versie	1

Nulpunt 1.75 +NAP

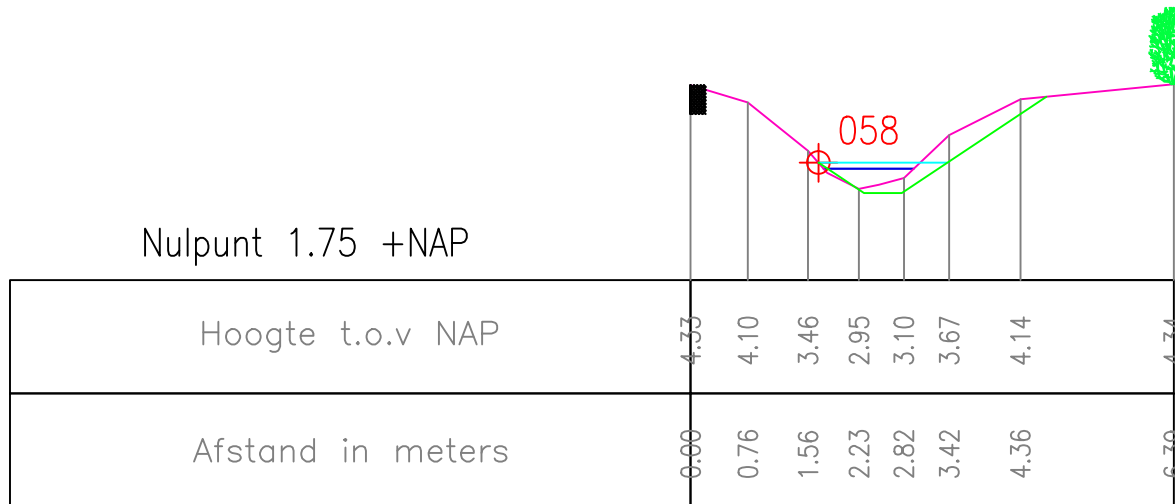

Oprachtgever		 HOOGHEEMRAADSCHAP DE STICHTSE RIJNLANDEN		Postbus 550 3990 GJ Houten		Poldermolen 2 3994 DD Houten					
Project		<h2>Herprofilering Gooyerwetering</h2>									
Onderdeel		<h3>ontwerp-profiel</h3>									
Projectnr.		401024		Besteknr(s).		Documentnr.		Status		concept	
Formaat		Schaal		Getek.		Datum		Goedgek.		Akk.	
A4		1:100		D.S.		8-4-2015				Tek.nr.	
										58	
										Versie	
										1	

Nulpunt 1.75 +NAP

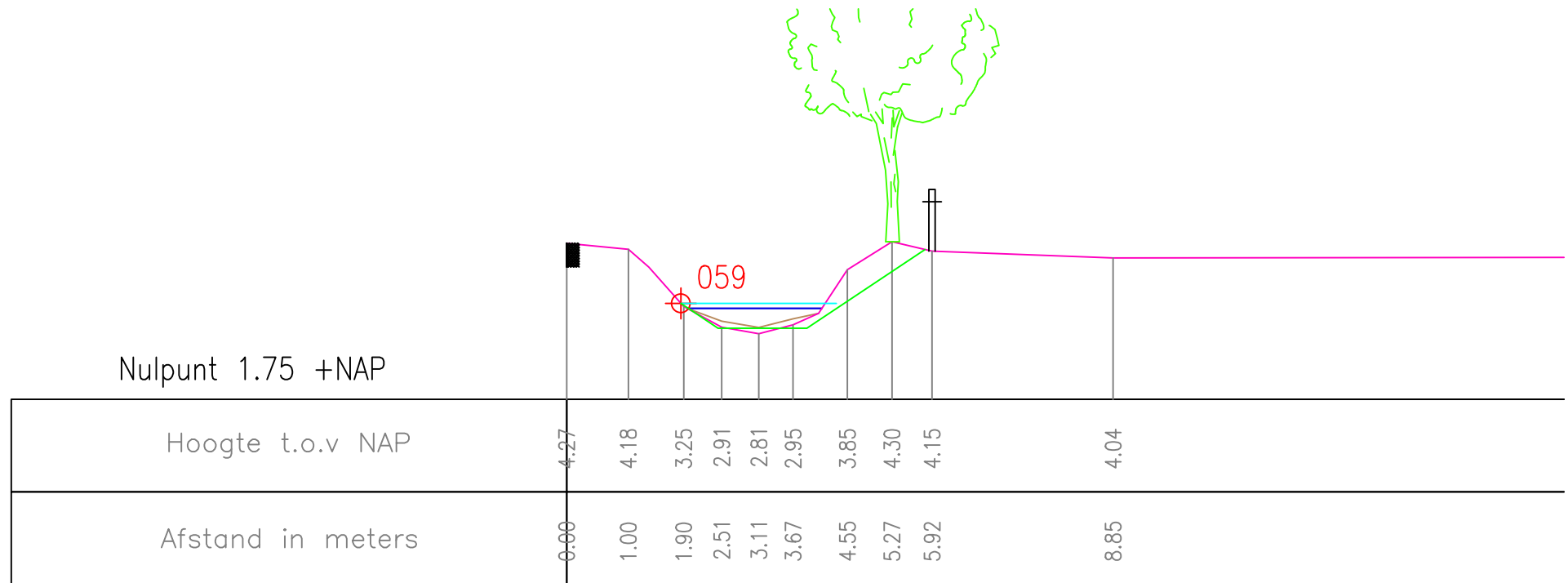

Oprachtgever		 HOOGHEEMRAADSCHAP DE STICHTSE RIJNLANDEN		Postbus 550 3990 GJ Houten		Poldermolen 2 3994 DD Houten	
Project		Herprofilering Gooyerwetering					
Onderdeel		ontwerp-profiel					
Projectnr.	401024	Besteknr(s).		Documentnr.		Status	concept
Formaat	A4	Schaal	1:100	Getek.	D.S.	Datum	8-4-2015
		Goedgek.		Akk.		Tek.nr.	59
						Versie	1

Nulpunt 1.75 +NAP

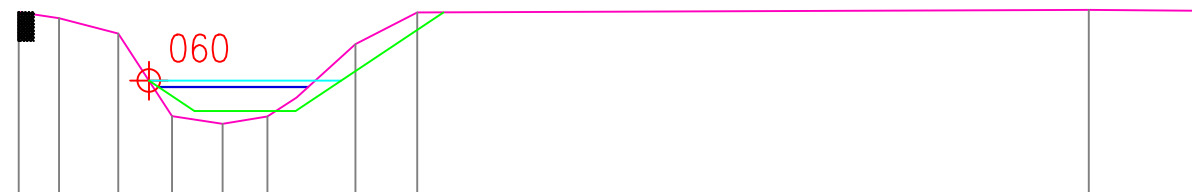

Hoogte t.o.v NAP	4.21	4.13	3.93	2.83	2.73	2.83	3.79	4.20		4.24
Afstand in meters	0.00	0.53	1.31	2.03	2.70	3.29	4.45	5.27		14.15

Oprichtgever		 HOOGHEEMRAADSCHAP DE STICHTSE RIJNLANDEN	Postbus 550 3990 GJ Houten	Poldermolen 2 3994 DD Houten
Project			Tel.: (030) 634 57 00 Fax: (030) 634 59 98	e-mail: post@hdsr.nl www.destichtserijnlanden.nl
Herprofilering Gooyerwetering Onderdeel ontwerp-profiel				
Projectnr.	401024	Besteknr(s).	Documentnr.	Status concept
Formaat A4	Schaal 1:100	Getek. D.S.	Datum 8-4-2015	Goedgek. Akk. Tek.nr. 60 Versie 1

Nulpunt 1.75 +NAP

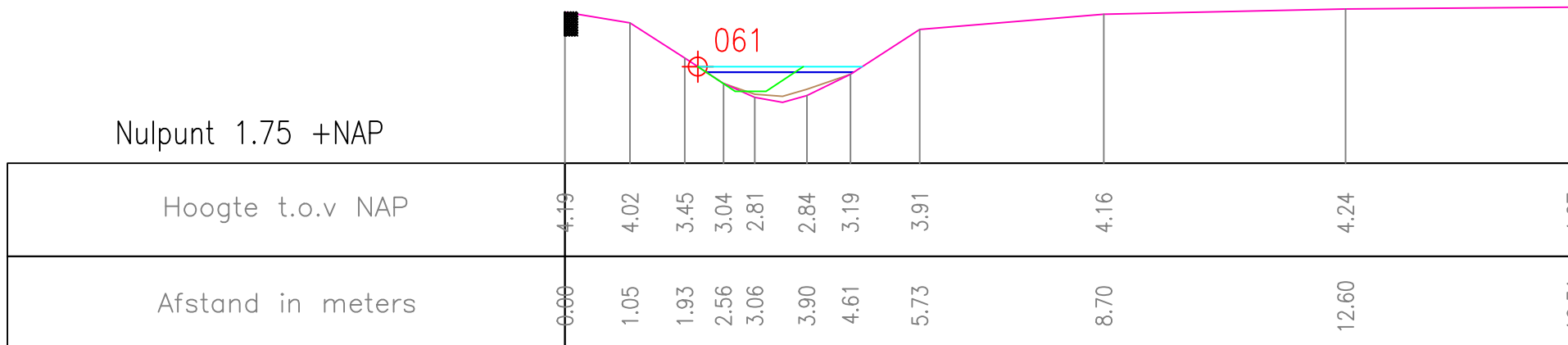

Opdrachtgever		 HOOGHEEMRAADSCHAP DE STICHTSE RIJNLANDEN		Postbus 550 3990 GJ Houten		Poldermolen 2 3994 DD Houten	
Project		Herprofilering Gooyerwetering					
Onderdeel		ontwerp-profiel					
Projectnr.	401024	Besteknr(s).		Documentnr.		Status	concept
Formaat	A4	Schaal	1:100	Getek.	D.S.	Datum	8-4-2015
Goedgek.		Akk.		Tek.nr.	61	Versie	1

Tel.: (030) 634 57 00
Fax: (030) 634 59 98

e-mail: post@hdsr.nl
www.destichtserijnlanden.nl

Nulpunt 1.75 +NAP



Hoogte t.o.v NAP	4.10	4.00	3.21	2.69	3.02	3.92			3.96
Afstand in meters	0.00	0.83	1.59	2.65	3.21	4.51			10.16

Opdrachtgever	 HOOGHEEMRAADSCHAP DE STICHTSE RIJNLANDEN	Postbus 550 3990 GJ Houten	Poldermolen 2 3994 DD Houten
Project		Tel.: (030) 634 57 00 Fax: (030) 634 59 98	e-mail: post@hdsr.nl www.destichtserijnlanden.nl

Herprofilering Gooyerwetering

Onderdeel
ontwerp-profiel

Projectnr.	401024	Besteknr(s).		Documentnr.		Status	concept						
Formaat	A4	Schaal	1:100	Getek.	D.S.	Datum	8-4-2015	Goedgek.	Akk.	Tek.nr.	62	Versie	1

Nulpunt 1.75 +NAP

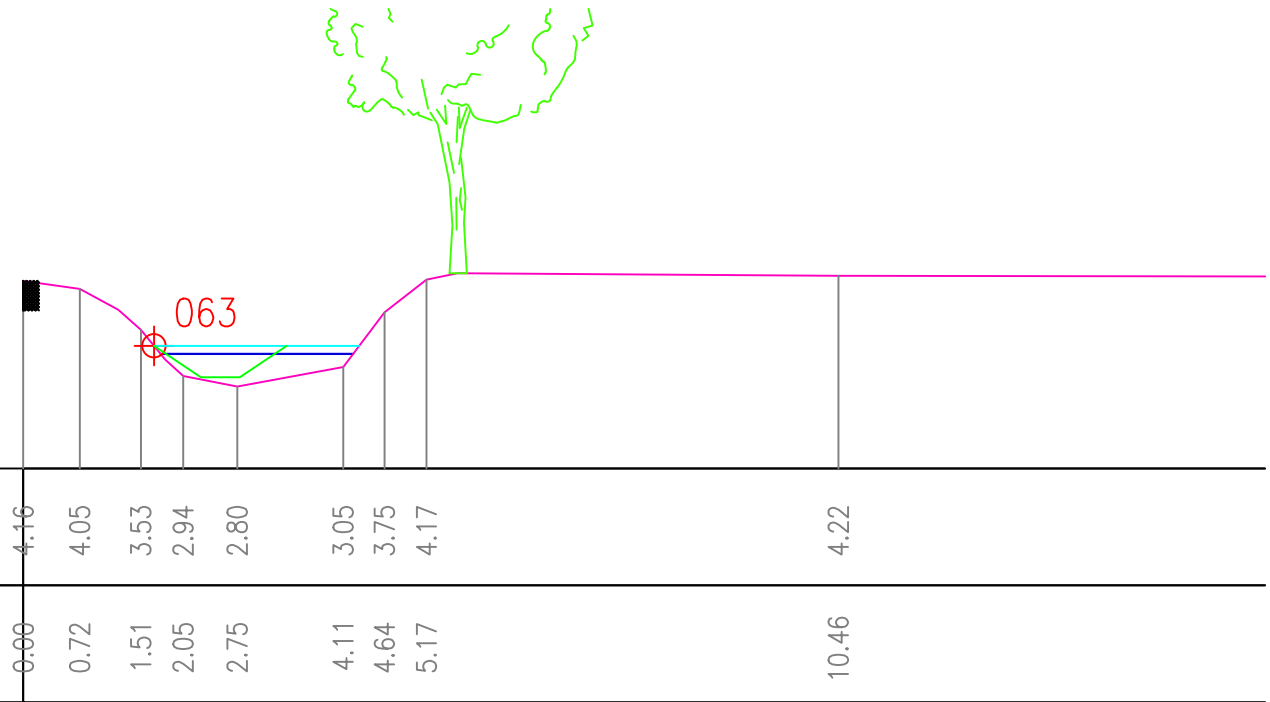

Oprichtgever		 HOOGHEEMRAADSCHAP DE STICHTSE RIJNLANDEN	Postbus 550 3990 GJ Houten		Poldermolen 2 3994 DD Houten								
Project			Tel.: (030) 634 57 00 Fax: (030) 634 59 98		e-mail: post@hdsr.nl www.destichtserijnlanden.nl								
Herprofilering Gooyerwetering ontwerp-profiel													
Projectnr.	401024	Besteknr(s).	Documentnr.		Status concept								
Formaat	A4	Schaal	1:100	Getek.	D.S.	Datum	8-4-2015	Goedgek.	Akk.	Tek.nr.	63	Versie	1

Nulpunt 1.75 +NAP

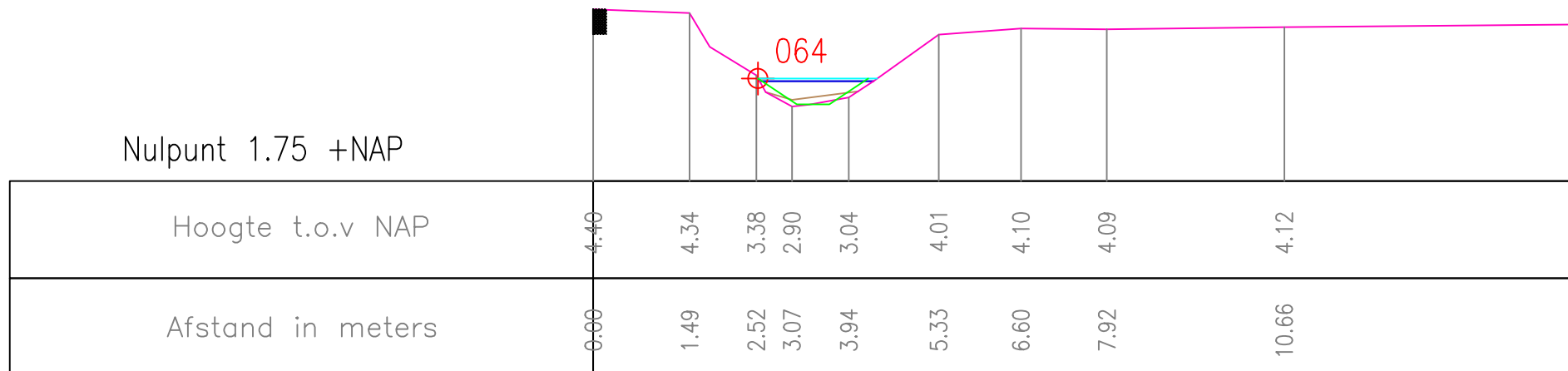

Oprachtgever		 HOOGHEEMRAADSCHAP DE STICHTSE RIJNLANDEN	Postbus 550 3990 GJ Houten	Poldermolen 2 3994 DD Houten									
Project			Tel.: (030) 634 57 00 Fax: (030) 634 59 98	e-mail: post@hdsr.nl www.destichtserijnlanden.nl									
Herprofilering Gooyerwetering Onderdeel ontwerp-profiel													
Projectnr.	401024	Besteknr(s).	Documentnr.	Status concept									
Formaat	A4	Schaal	1:100	Getek.	D.S.	Datum	8-4-2015	Goedgek.	Akk.	Tek.nr.	64	Versie	1

Nulpunt 1.75 +NAP

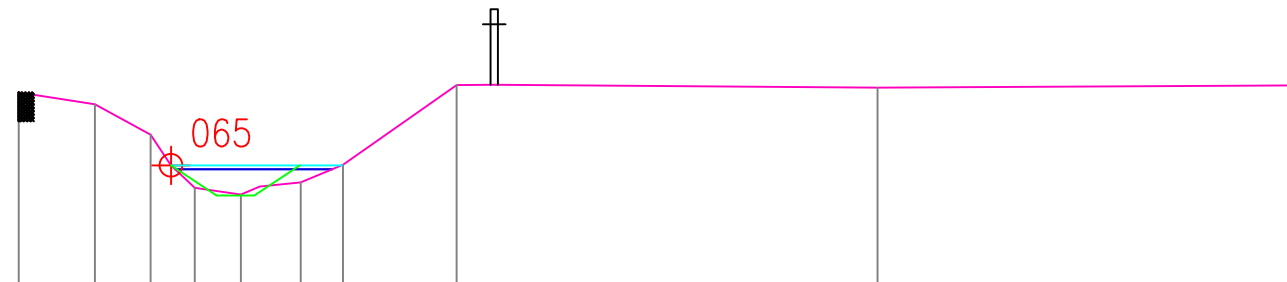

Hoogte t.o.v NAP	4.30	4.15	3.74	3.04	2.96	3.12	3.35	4.40	4.37
Afstand in meters	0.00	1.01	1.74	2.33	2.94	3.73	4.29	5.79	11.36

Oprachtgever		 HOOGHEEMRAADSCHAP DE STICHTSE RIJNLANDEN	Postbus 550 3990 GJ Houten	Poldermolen 2 3994 DD Houten
Project			Tel.: (030) 634 57 00 Fax: (030) 634 59 98	e-mail: post@hdsr.nl www.destichtserijnlanden.nl
Herprofilering Gooyerwetering Onderdeel ontwerp-profiel				
Projectnr.	401024	Besteknr(s).	Documentnr.	Status concept
Formaat A4	Schaal 1:100	Getek. D.S.	Datum 8-4-2015	Goedgek. Akk. Tek.nr. 65
				Versie 1

Nulpunt 1.75 +NAP

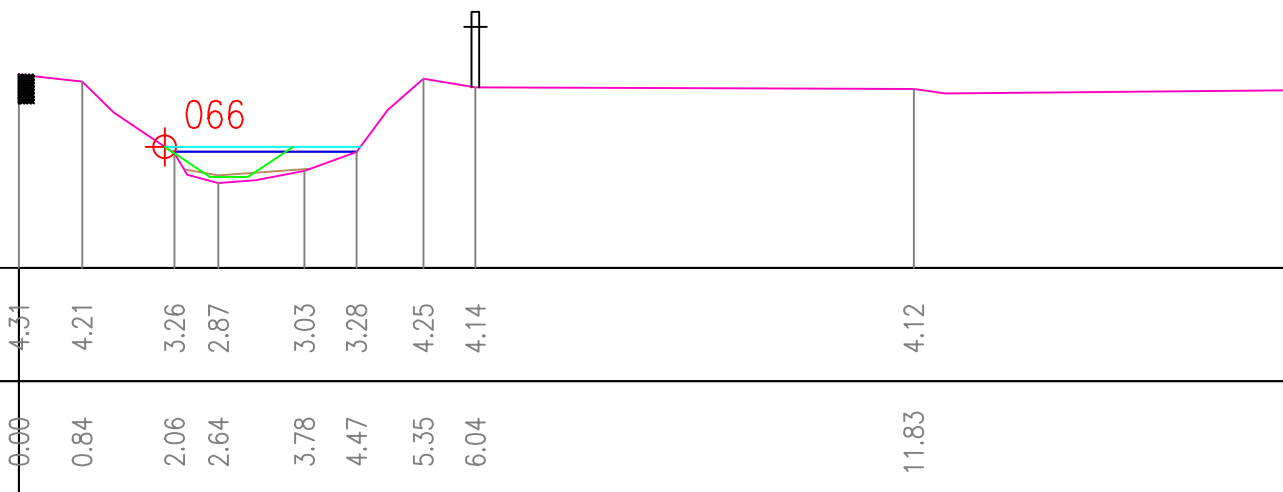

Oprachtgever		 HOOGHEEMRAADSCHAP DE STICHTSE RIJNLANDEN	Postbus 550 3990 GJ Houten	Poldermolen 2 3994 DD Houten									
Project			Tel.: (030) 634 57 00 Fax: (030) 634 59 98	e-mail: post@hdsr.nl www.destichtserijnlanden.nl									
Herprofilering Gooyerwetering Onderdeel ontwerp-profiel													
Projectnr.	401024	Besteknr(s).	Documentnr.	Status concept									
Formaat	A4	Schaal	1:100	Getek.	D.S.	Datum	8-4-2015	Goedgek.	Akk.	Tek.nr.	66	Versie	1

Nulpunt 1.75 +NAP

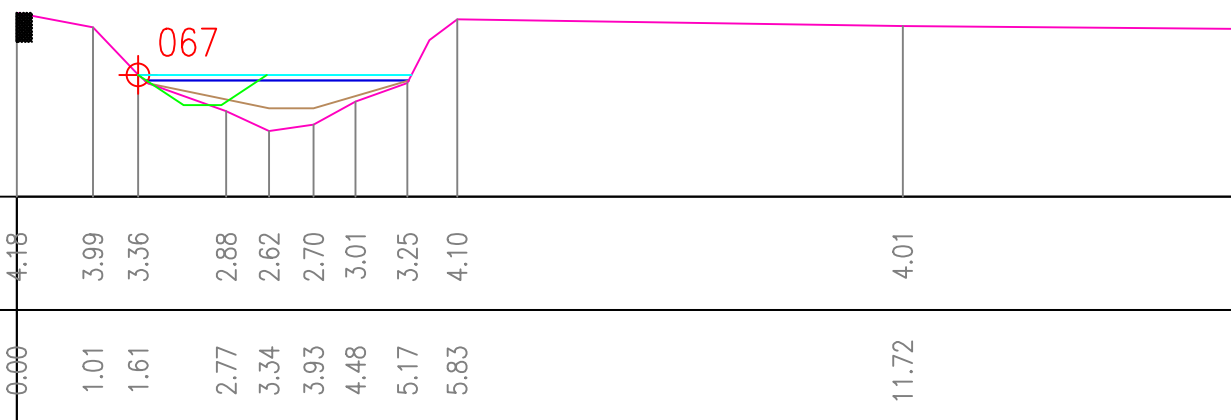

Opdrachtgever		 HOOGHEEMRAADSCHAP DE STICHTSE RIJNLANDEN	Postbus 550 3990 GJ Houten	Poldermolen 2 3994 DD Houten									
Project			Tel.: (030) 634 57 00 Fax: (030) 634 59 98	e-mail: post@hdsr.nl www.destichtserijnlanden.nl									
Project <h2>Herprofilering Gooyerwetering</h2>													
Onderdeel <h3>ontwerp-profiel</h3>													
Projectnr.	401024	Besteknr(s).	Documentnr.	Status concept									
Formaat	A4	Schaal	1:100	Getek.	D.S.	Datum	8-4-2015	Goedgek.	Akk.	Tek.nr.	67	Versie	1

Nulpunt 1.75 +NAP

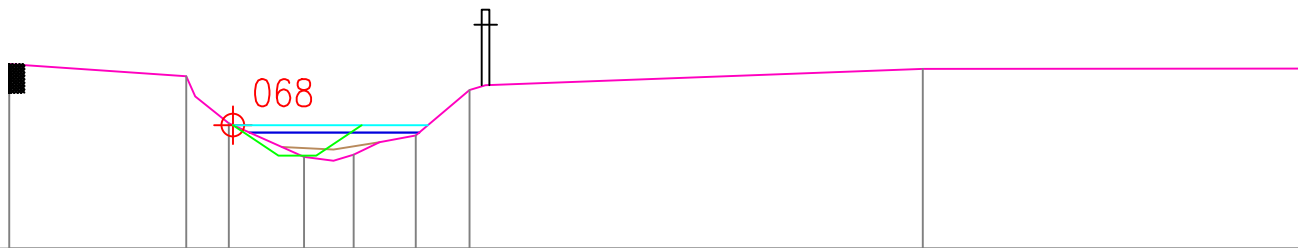

Hoogte t.o.v NAP	4.19	4.03	3.41	2.96	2.99	3.25	3.85	4.13
Afstand in meters	0.00	2.34	2.91	3.90	4.56	5.38	6.09	12.08

Opdrachtgever	 HOOGHEEMRAADSCHAP DE STICHTSE RIJNLANDEN	Postbus 550 3990 GJ Houten	Poldermolen 2 3994 DD Houten
Project		Tel.: (030) 634 57 00 Fax: (030) 634 59 98	e-mail: post@hdsr.nl www.destichtserijnlanden.nl

Herprofilering Gooyerwetering

Onderdeel
ontwerp-profiel

Projectnr.	401024	Besteknr(s).	Documentnr.	Status	concept								
Formaat	A4	Schaal	1:100	Getek.	D.S.	Datum	8-4-2015	Goedgek.	Akk.	Tek.nr.	68	Versie	1

Nulpunt 1.75 +NAP

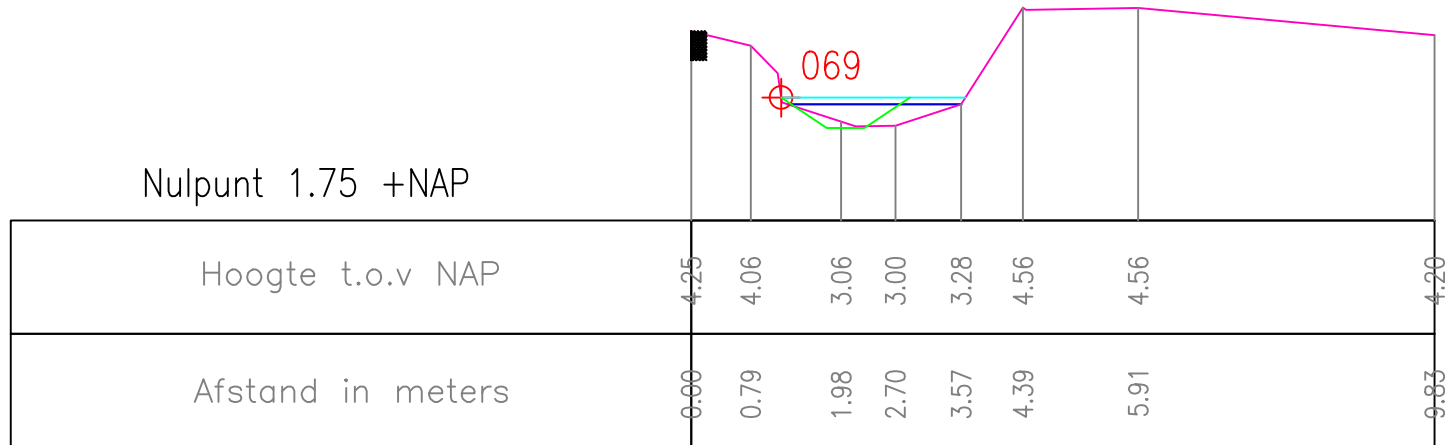

Oprachtgever		 HOOGHEEMRAADSCHAP DE STICHTSE RIJNLANDEN	Postbus 550 3990 GJ Houten		Poldermolen 2 3994 DD Houten	
			Tel.: (030) 634 57 00 Fax: (030) 634 59 98		e-mail: post@hdsr.nl www.destichtserijnlanden.nl	
Project						
Herprofilering Gooyerwetering						
Onderdeel						
ontwerp-profiel						
Projectnr. 401024		Besteknr(s).		Documentnr.		Status concept
Formaat A4	Schaal 1:100	Getek. D.S.	Datum 8-4-2015	Goedgek.	Akk.	Tek.nr. 69 Versie 1

Nulpunt 1.75 +NAP

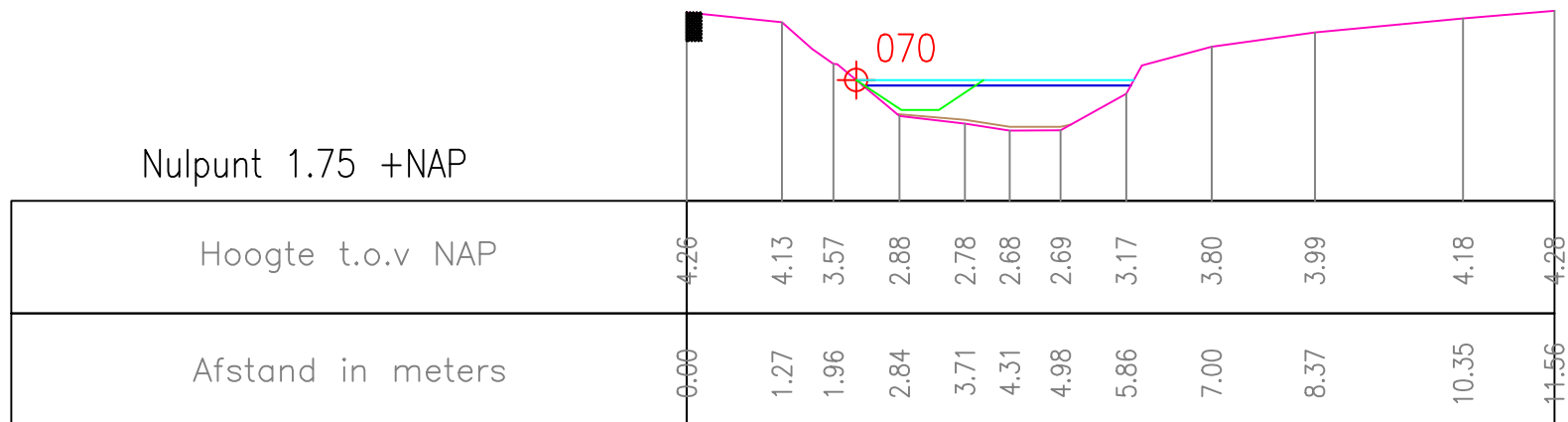

Opdrachtgever		 HOOGHEEMRAADSCHAP DE STICHTSE RIJNLANDEN		Postbus 550 3990 GJ Houten		Poldermolen 2 3994 DD Houten	
Project		Herprofilering Gooyerwetering					
Onderdeel		ontwerp-profiel					
Projectnr.	401024	Besteknr(s).		Documentnr.		Status	concept
Formaat	A4	Schaal	1:100	Getek.	D.S.	Datum	8-4-2015
		Goedgek.		Akk.		Tek.nr.	70
						Versie	1

Nulpunt 1.75 +NAP

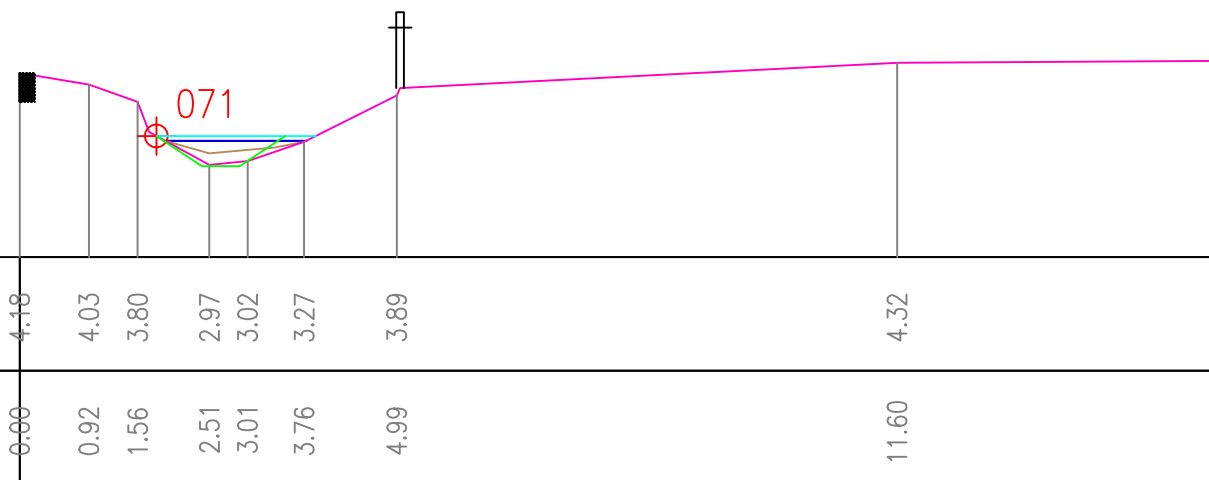

Opdrachtgever		 HOOGHEEMRAADSCHAP DE STICHTSE RIJNLANDEN		Postbus 550 3990 GJ Houten Tel.: (030) 634 57 00 Fax: (030) 634 59 98		Poldermolen 2 3994 DD Houten e-mail: post@hdsr.nl www.destichtserijnlanden.nl	
Project							
Herprofilering Gooyerwetering							
Onderdeel							
ontwerp-profiel							
Projectnr.		Besteknr(s).		Documentnr.		Status	
401024						concept	
Formaat	Schaal	Getek.	Datum	Goedgek.	Akk.	Tek.nr.	Versie
A4	1:100	D.S.	8-4-2015			71	1

Nulpunt 1.75 +NAP

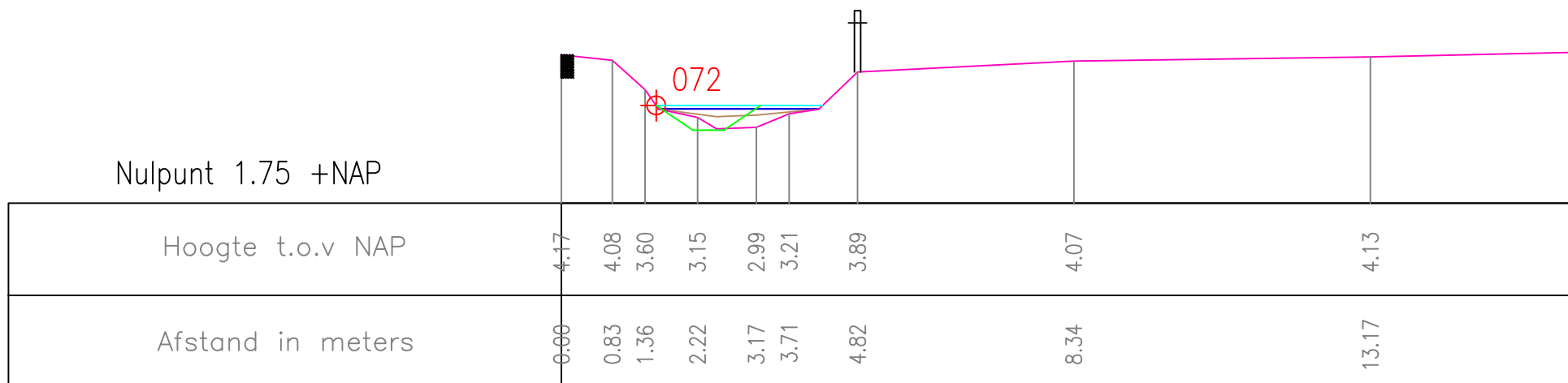

Opdrachtgever		 HOOGHEEMRAADSCHAP DE STICHTSE RIJNLANDEN	Postbus 550 3990 GJ Houten	Poldermolen 2 3994 DD Houten									
Project			Tel.: (030) 634 57 00 Fax: (030) 634 59 98	e-mail: post@hdsr.nl www.destichtserijnlanden.nl									
Herprofilering Gooyerwetering Onderdeel ontwerp-profiel													
Projectnr.	401024	Besteknr(s).	Documentnr.	Status concept									
Formaat	A4	Schaal	1:100	Getek.	D.S.	Datum	8-4-2015	Goedgek.	Akk.	Tek.nr.	72	Versie	1

Nulpunt 1.75 +NAP

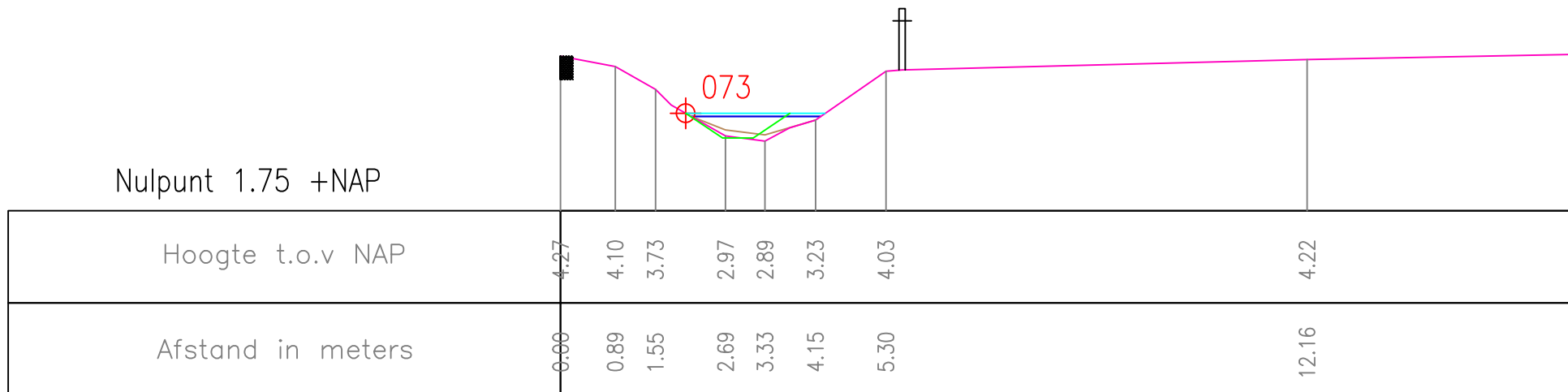

Opdrachtgever		 HOOGHEEMRAADSCHAP DE STICHTSE RIJNLANDEN	Postbus 550 3990 GJ Houten	Poldermolen 2 3994 DD Houten
Project			Tel.: (030) 634 57 00 Fax: (030) 634 59 98	e-mail: post@hdsr.nl www.destichtserijnlanden.nl
Herprofilering Gooyerwetering Onderdeel ontwerp-profiel				
Projectnr.	401024	Besteknr(s).	Documentnr.	Status concept
Formaat A4	Schaal 1:100	Getek. D.S.	Datum 8-4-2015	Goedgek. Akk. Tek.nr. 73 Versie 1

Nulpunt 1.75 +NAP

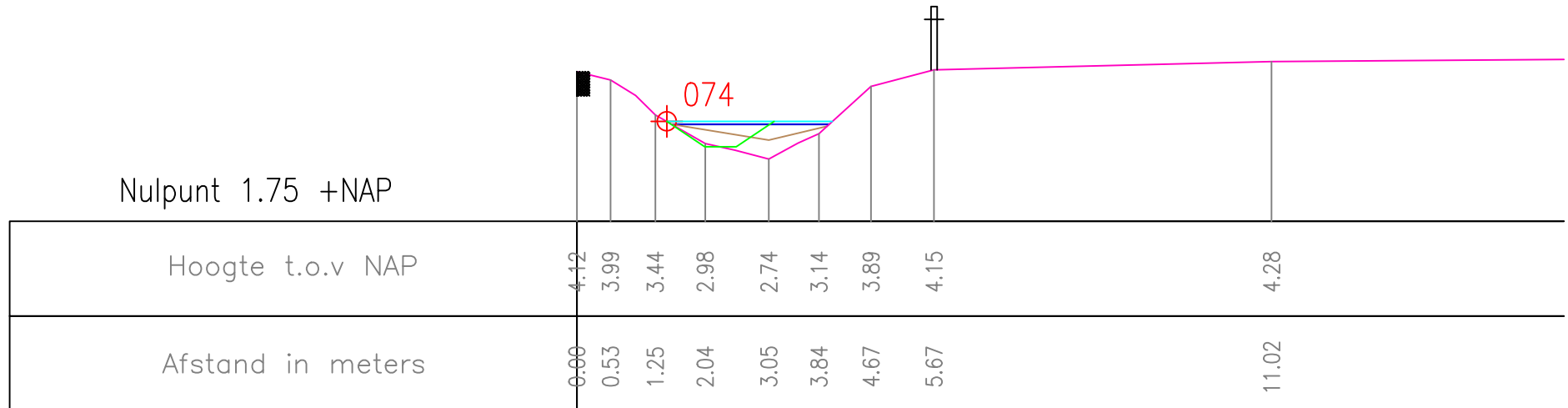

Opdrachtgever		 HOOGHEEMRAADSCHAP DE STICHTSE RIJNLANDEN	Postbus 550 3990 GJ Houten	Poldermolen 2 3994 DD Houten
Project			Tel.: (030) 634 57 00 Fax: (030) 634 59 98	e-mail: post@hdsr.nl www.destichtserijnlanden.nl
Herprofilering Gooyerwetering Onderdeel ontwerp-profiel				
Projectnr.	401024	Besteknr(s).	Documentnr.	Status concept
Formaat A4	Schaal 1:100	Getek. D.S.	Datum 8-4-2015	Goedgek. Akk. Tek.nr. 74
				Versie 1

Nulpunt 1.75 +NAP

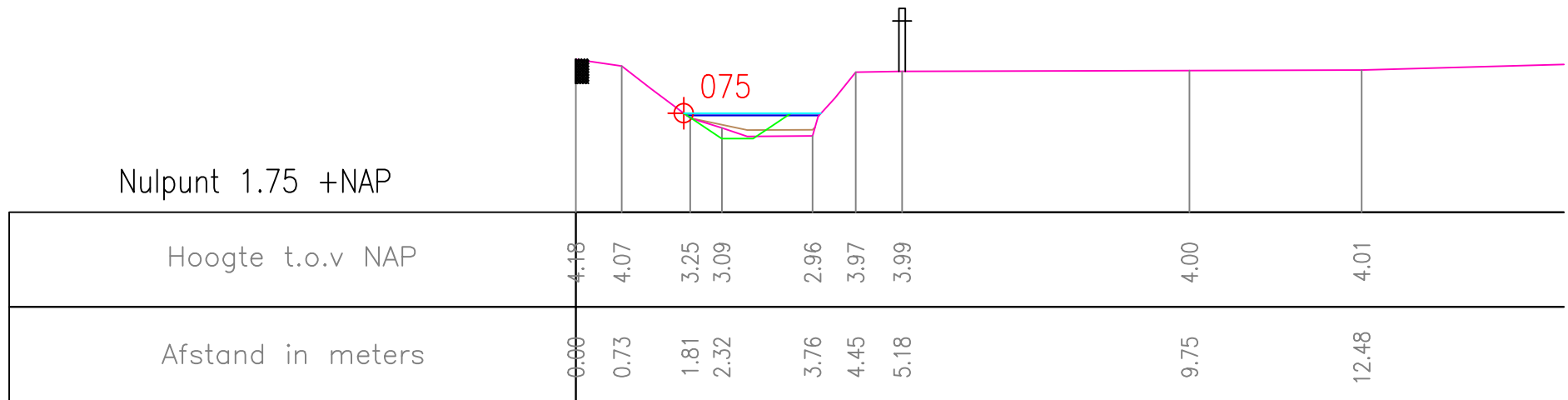

Opdrachtgever		 HOOGHEEMRAADSCHAP DE STICHTSE RIJNLANDEN	Postbus 550 3990 GJ Houten		Poldermolen 2 3994 DD Houten	
Project			Tel.: (030) 634 57 00 Fax: (030) 634 59 98		e-mail: post@hdsr.nl www.destichtserijnlanden.nl	
Herprofilering Gooyerwetering ontwerp-profiel						
Projectnr.		Besteknr(s).		Documentnr.		Status
401024						concept
Formaat	Schaal	Getek.	Datum	Goedgek.	Akk.	Tek.nr.
A4	1:100	D.S.	8-4-2015			75
						Versie
						1

Nulpunt 1.75 +NAP



Hoogte t.o.v NAP	4.22	4.03	3.30	3.06	2.95	3.30	4.02	4.19
Afstand in meters	0.00	0.77	1.55	2.09	3.19	3.93	5.18	12.31

Opdrachtgever	 HOOGHEEMRAADSCHAP DE STICHTSE RIJNLANDEN	Postbus 550 3990 GJ Houten	Poldermolen 2 3994 DD Houten
Project		Tel.: (030) 634 57 00 Fax: (030) 634 59 98	e-mail: post@hdsr.nl www.destichtserijnlanden.nl

Herprofilering Gooyerwetering

Onderdeel
ontwerp-profiel

Projectnr.	401024	Besteknr(s).	Documentnr.	Status	concept								
Formaat	A4	Schaal	1:100	Getek.	D.S.	Datum	8-4-2015	Goedgek.	Akk.	Tek.nr.	76	Versie	1

Nulpunt 1.75 +NAP

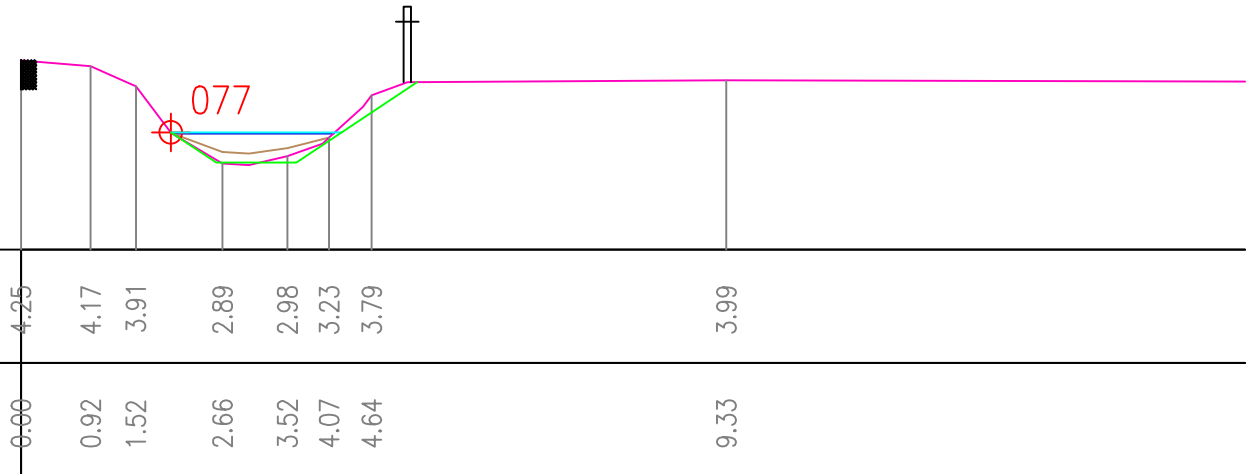

Oprachtgever		 HOOGHEEMRAADSCHAP DE STICHTSE RIJNLANDEN		Postbus 550 3990 GJ Houten		Poldermolen 2 3994 DD Houten	
				Tel.: (030) 634 57 00		e-mail: post@hdsr.nl	
				Fax: (030) 634 59 98		www.destichtserijnlanden.nl	
Project							
Herprofilering Gooyerwetering							
Onderdeel							
ontwerp-profiel							
Projectnr.		Besteknr(s).		Documentnr.		Status	
401024						concept	
Formaat	Schaal	Getek.	Datum	Goedgek.	Akk.	Tek.nr.	Versie
A4	1:100	D.S.	8-4-2015			77	1

Nulpunt 2.75 +NAP

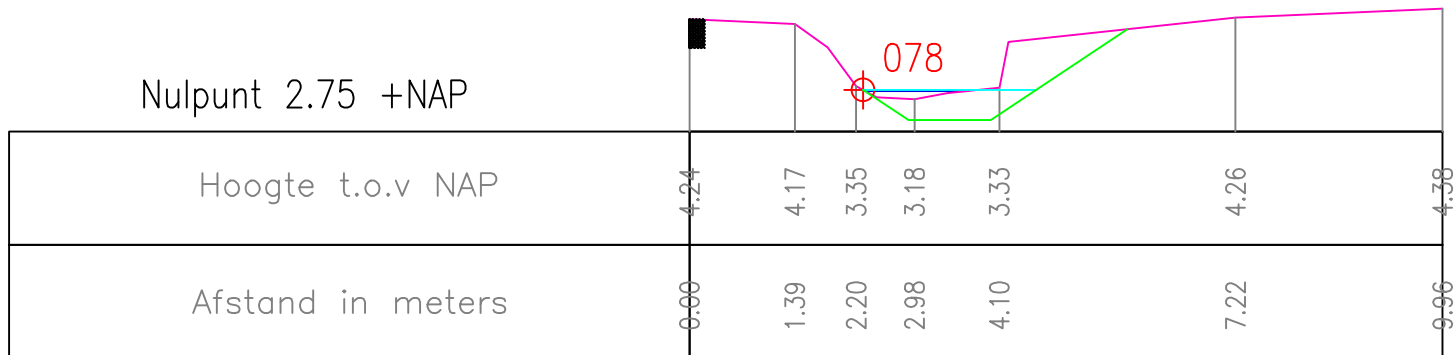

Oprachtgever		 HOOGHEEMRAADSCHAP DE STICHTSE RIJNLANDEN		Postbus 550 3990 GJ Houten Tel.: (030) 634 57 00 Fax: (030) 634 59 98		Poldermolen 2 3994 DD Houten e-mail: post@hdsr.nl www.destichtserijnlanden.nl	
Project							
Herprofilering Gooyerwetering							
Onderdeel							
ontwerp-profiel							
Projectnr.		Besteknr(s).		Documentnr.		Status	
401024						concept	
Formaat	Schaal	Getek.	Datum	Goedgek.	Akk.	Tek.nr.	Versie
A4	1:100	D.S.	8-4-2015			78	1

Nulpunt 1.75 +NAP

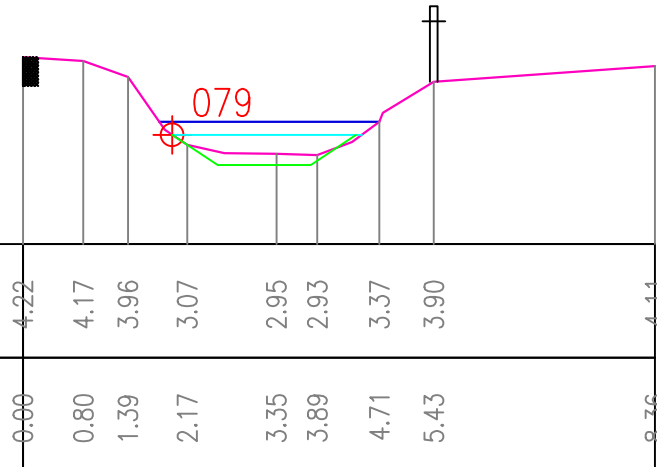

Oprachtgever		 HOOGHEEMRAADSCHAP DE STICHTSE RIJNLANDEN	Postbus 550 3990 GJ Houten	Poldermolen 2 3994 DD Houten									
Project			Tel.: (030) 634 57 00 Fax: (030) 634 59 98	e-mail: post@hdsr.nl www.destichtserijnlanden.nl									
<p>Onderdeel</p> <h2>Herprofilering Gooyerwetering</h2> <h3>ontwerp-profiel</h3>													
Projectnr.	401024	Besteknr(s).	Documentnr.	Status concept									
Formaat	A4	Schaal	1:100	Getek.	D.S.	Datum	8-4-2015	Goedgek.	Akk.	Tek.nr.	79	Versie	1

Nulpunt 1.75 +NAP

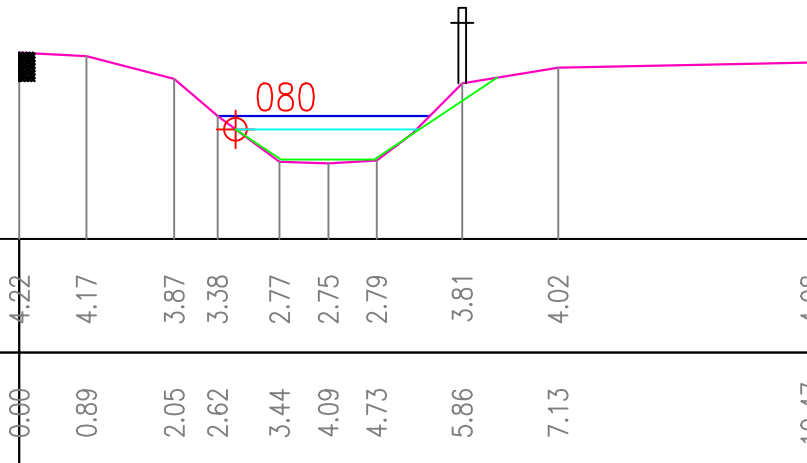

Oprachtgever		 HOOGHEEMRAADSCHAP DE STICHTSE RIJNLANDEN	Postbus 550 3990 GJ Houten	Poldermolen 2 3994 DD Houten									
Project			Tel.: (030) 634 57 00 Fax: (030) 634 59 98	e-mail: post@hdsr.nl www.destichtserijnlanden.nl									
Onderdeel		Herprofilering Gooyerwetering ontwerp-profiel											
Projectnr.	401024	Besteknr(s).	Documentnr.	Status concept									
Formaat	A4	Schaal	1:100	Getek.	D.S.	Datum	8-4-2015	Goedgek.	Akk.	Tek.nr.	80	Versie	1

Nulpunt 1.75 +NAP

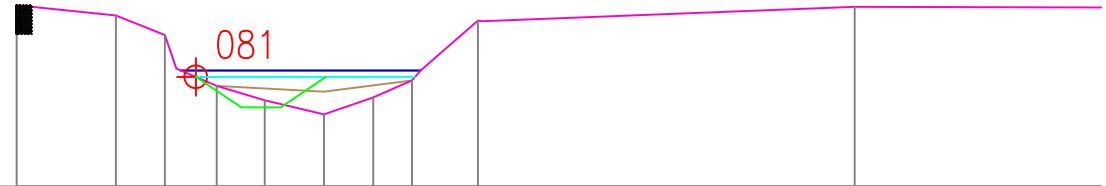

Hoogte t.o.v NAP	4.15	4.01	3.76	3.08	2.89	2.71	2.93	3.15	3.94	4.13
Afstand in meters	0.00	1.32	1.96	2.65	3.28	4.07	4.72	5.23	6.10	11.08

Oprachtgever	 HOOGHEEMRAADSCHAP DE STICHTSE RIJNLANDEN	Postbus 550 3990 GJ Houten	Poldermolen 2 3994 DD Houten
Project		Tel.: (030) 634 57 00 Fax: (030) 634 59 98	e-mail: post@hdrs.nl www.destichtserijnlanden.nl

Herprofilering Gooyerwetering

Onderdeel
ontwerp-profiel

Projectnr.	401024	Besteknr(s).		Documentnr.		Status	concept						
Formaat	A4	Schaal	1:100	Getek.	D.S.	Datum	8-4-2015	Goedgek.	Akk.	Tek.nr.	81	Versie	1

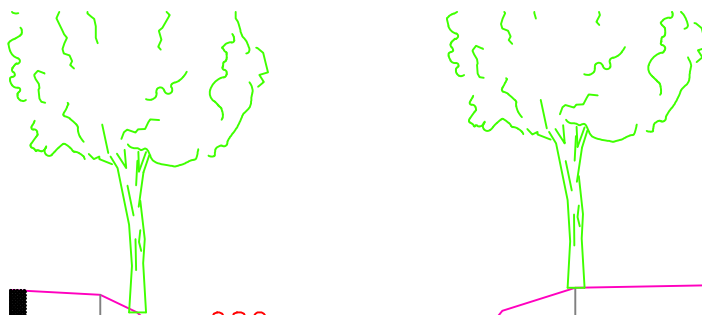

Nulpunt 1.75 +NAP

Hoogte t.o.v NAP	4.11	4.05	3.23	2.79	2.99	3.14	3.76	4.15	4.21	4.41
Afstand in meters	0.00	1.18	2.32	4.59	5.37	5.91	6.43	7.47	11.13	15.31

Oprachtgever	 HOOGHEEMRAADSCHAP DE STICHTSE RIJNLANDEN	Postbus 550 3990 GJ Houten	Poldermolen 2 3994 DD Houten
Project		Tel.: (030) 634 57 00 Fax: (030) 634 59 98	e-mail: post@hdsr.nl www.destichtserijnlanden.nl

Herprofilering Gooyerwetering

Onderdeel
ontwerp-profiel

Projectnr.	401024	Besteknr(s).	Documentnr.	Status	concept								
Formaat	A4	Schaal	1:100	Getek.	D.S.	Datum	8-4-2015	Goedgek.	Akk.	Tek.nr.	82	Versie	1

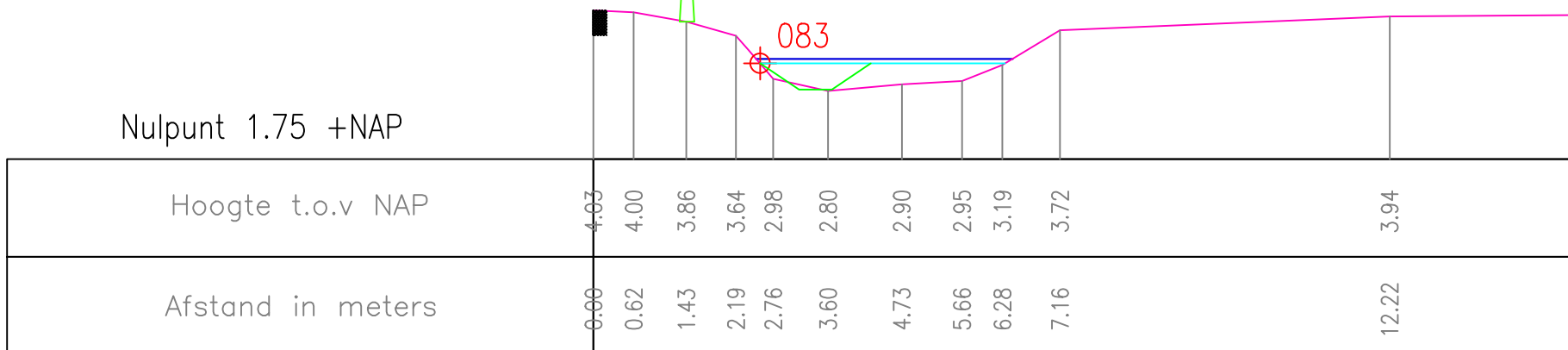
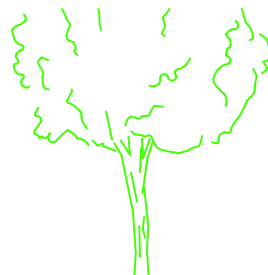

Opdrachtgever		 HOOGHEEMRAADSCHAP DE STICHTSE RIJNLANDEN		Postbus 550 3990 GJ Houten		Poldermolen 2 3994 DD Houten	
Project		Herprofilering Gooyerwetering					
Onderdeel		ontwerp-profiel					
Projectnr.	401024	Besteknr(s).		Documentnr.		Status	concept
Formaat	A4	Schaal	1:100	Getek.	D.S.	Datum	8-4-2015
		Goedgek.		Akk.		Tek.nr.	83
						Versie	1

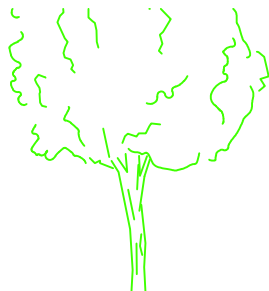

084

Nulpunt 1.75 +NAP

Hoogte t.o.v NAP	3.91	3.92	3.69	3.11	2.84	2.95	3.27	3.86	4.12	4.10
Afstand in meters	0.00	0.85	2.28	3.21	4.28	5.17	6.27	6.82	7.98	12.31

Oprichtgever		 HOOGHEEMRAADSCHAP DE STICHTSE RIJNLANDEN	Postbus 550 3990 GJ Houten		Poldermolen 2 3994 DD Houten		
Project			Tel.: (030) 634 57 00 Fax: (030) 634 59 98		e-mail: post@hdsr.nl www.destichtserijnlanden.nl		
Herprofilering Gooyerwetering Onderdeel ontwerp-profiel							
Projectnr. 401024		Besteknr(s).		Documentnr.		Status concept	
Formaat A4	Schaal 1:100	Getek. D.S.	Datum 8-4-2015	Goedgek.	Akk.	Tek.nr. 84	Versie 1

Nulpunt 1.75 +NAP

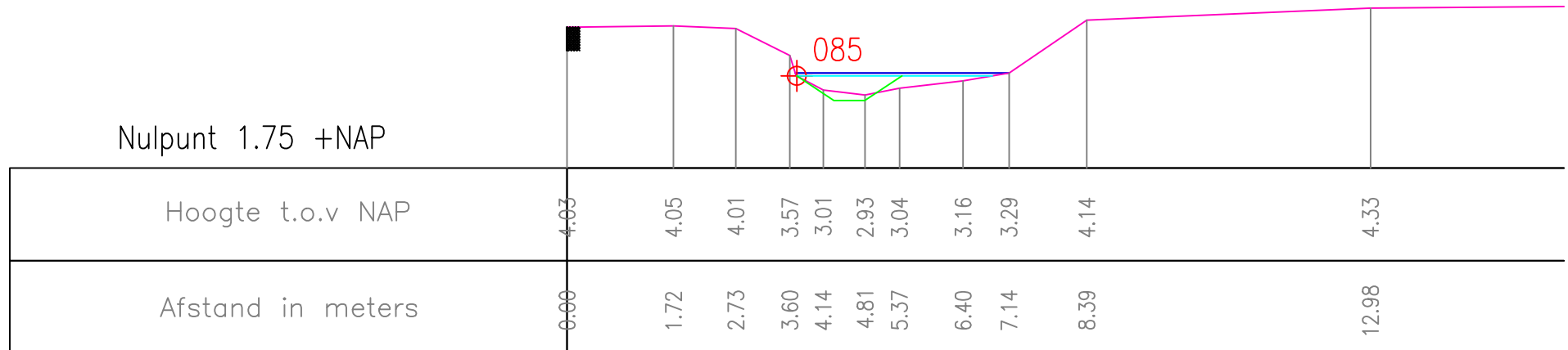

Opdrachtgever		 HOOGHEEMRAADSCHAP DE STICHTSE RIJNLANDEN	Postbus 550 3990 GJ Houten	Poldermolen 2 3994 DD Houten									
Project			Tel.: (030) 634 57 00 Fax: (030) 634 59 98	e-mail: post@hdrs.nl www.destichtserijnlanden.nl									
Herprofilering Gooyerwetering Onderdeel ontwerp-profiel													
Projectnr.	401024	Besteknr(s).	Documentnr.	Status concept									
Formaat	A4	Schaal	1:100	Getek.	D.S.	Datum	8-4-2015	Goedgek.	Akk.	Tek.nr.	85	Versie	1

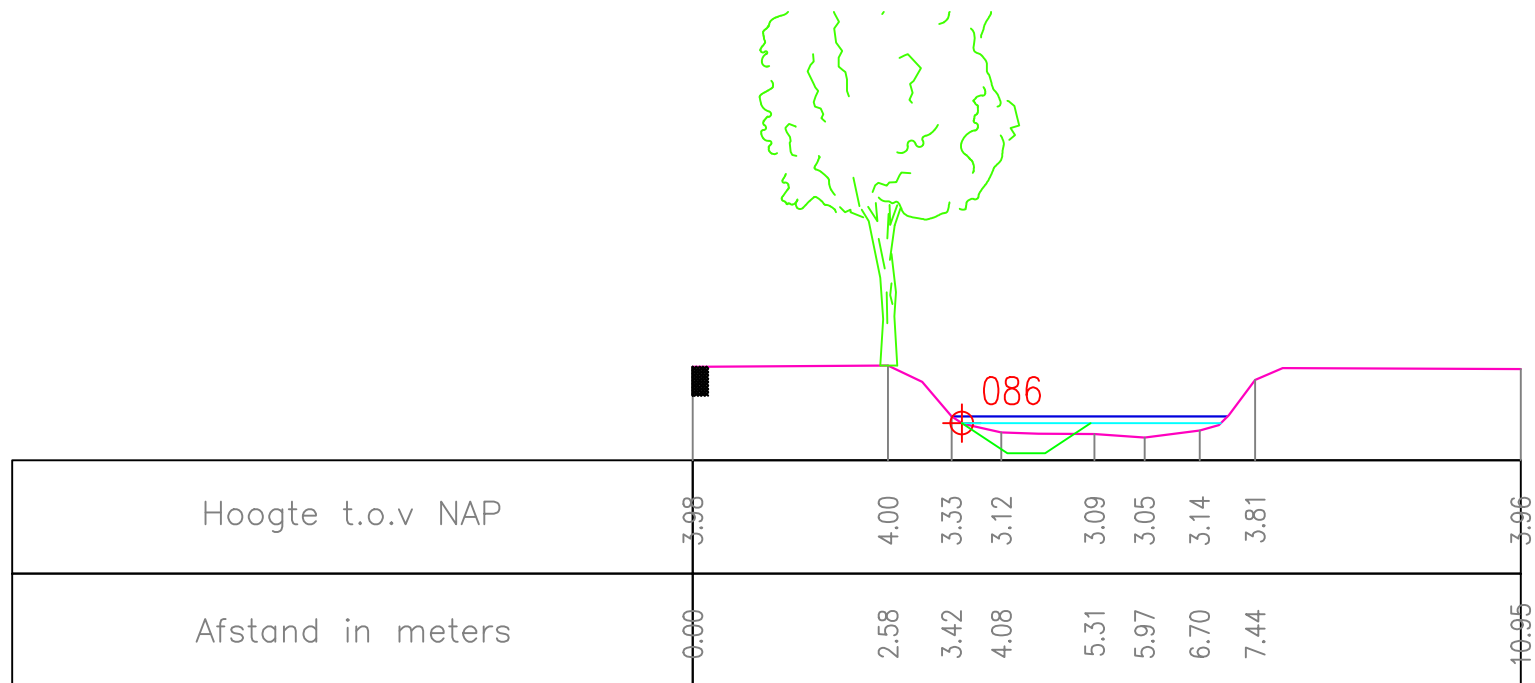

Oprachtgever		 HOOGHEEMRAADSCHAP DE STICHTSE RIJNLANDEN	Postbus 550 3990 GJ Houten		Poldermolen 2 3994 DD Houten		
			Tel.: (030) 634 57 00 Fax: (030) 634 59 98		e-mail: post@hdsr.nl www.destichtserijnlanden.nl		
Project							
Herprofilering Gooyerwetering							
Onderdeel							
ontwerp-profiel							
Projectnr.		Besteknr(s).		Documentnr.		Status	
401024						concept	
Formaat	Schaal	Getek.	Datum	Goedgek.	Akk.	Tek.nr.	Versie
A4	1:100	D.S.	8-4-2015			86	1