

Situatietekening bestaand

Voorgevel

Linkergevel

Achtergevel

Begane grond 1/100

1e verdieping

Behoort bij beschikking	
d.d.	19-10-2015
nr.(s)	ZK15000872
Medewerker Publiekszaken/vergunningen	

BEM1504595
gemeente Steenbergen

VANSCHAGEN ARCHITECTEN

W1593 | planmatig onderhoud 10 woningen
De Ruyterstraat Dinteloord
gevelrenovatie

Overzichtstekening bestaande situatie
Gewijzigd: 9-9-2015
Schaal: 1/100
Formaat: A1



Voorkant



Achterkant

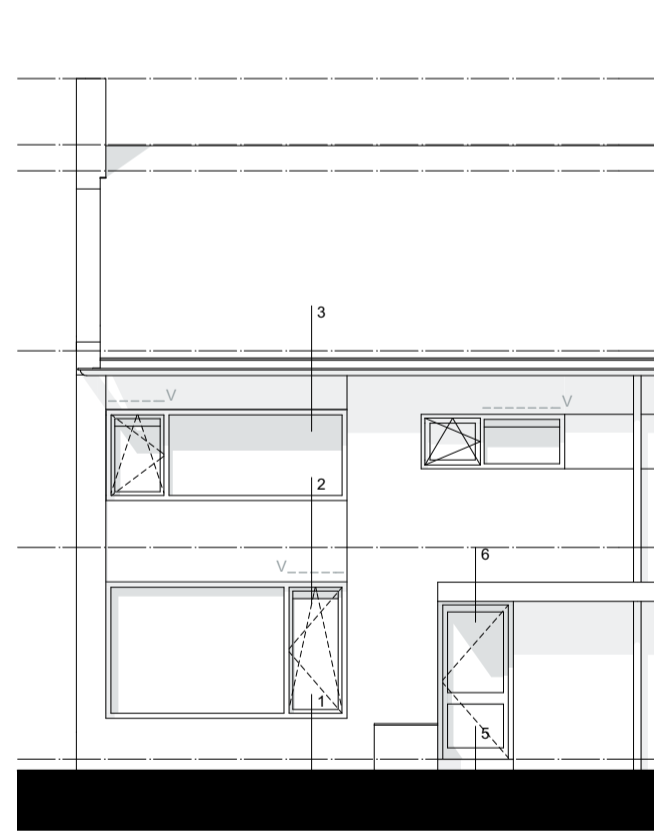

Voorgevel 1/100

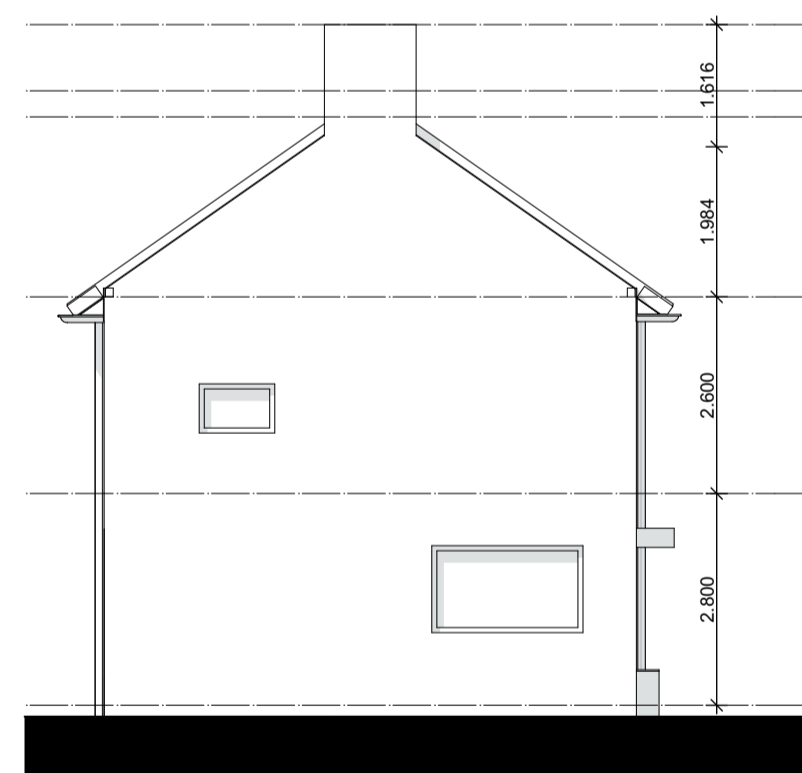

Linkergevel 1/100

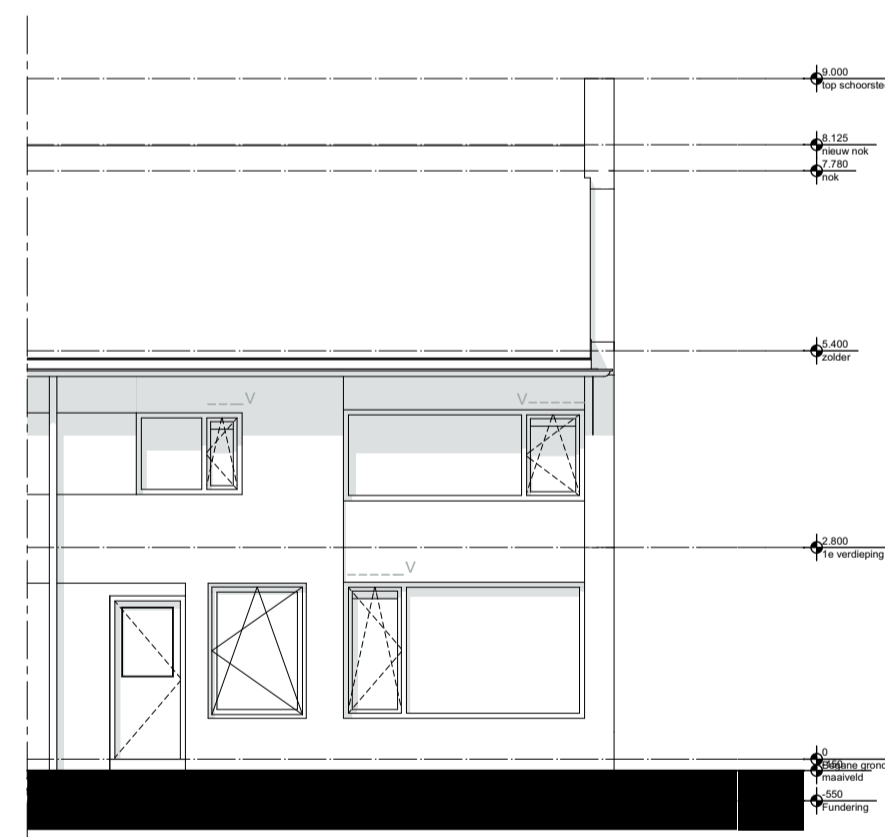

Achtergevel 1/100

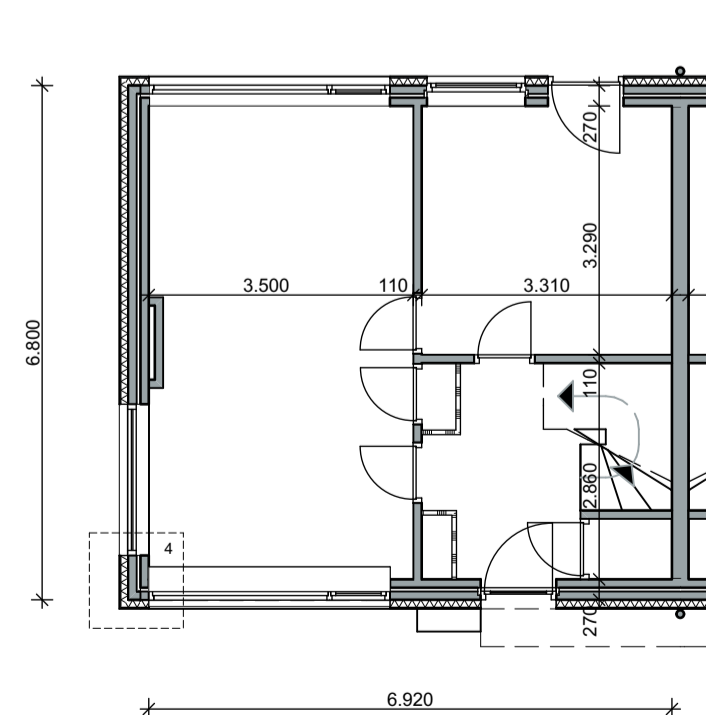

Begane grond 1/00

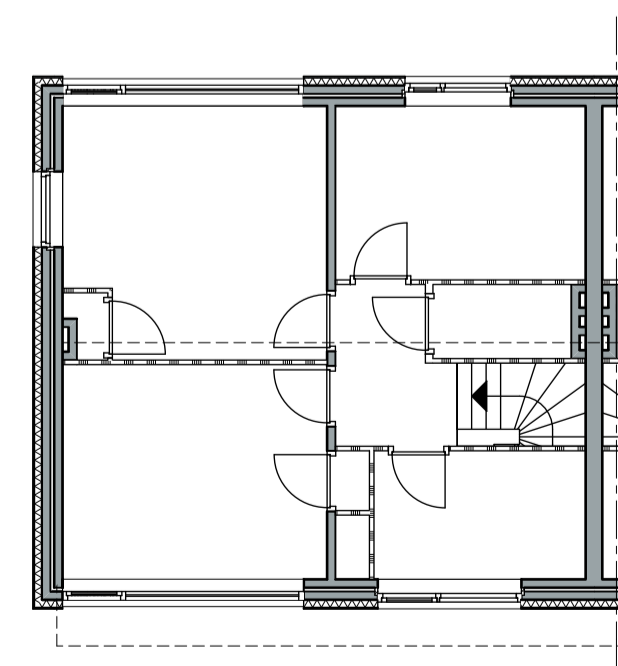

1e verdieping 1/100

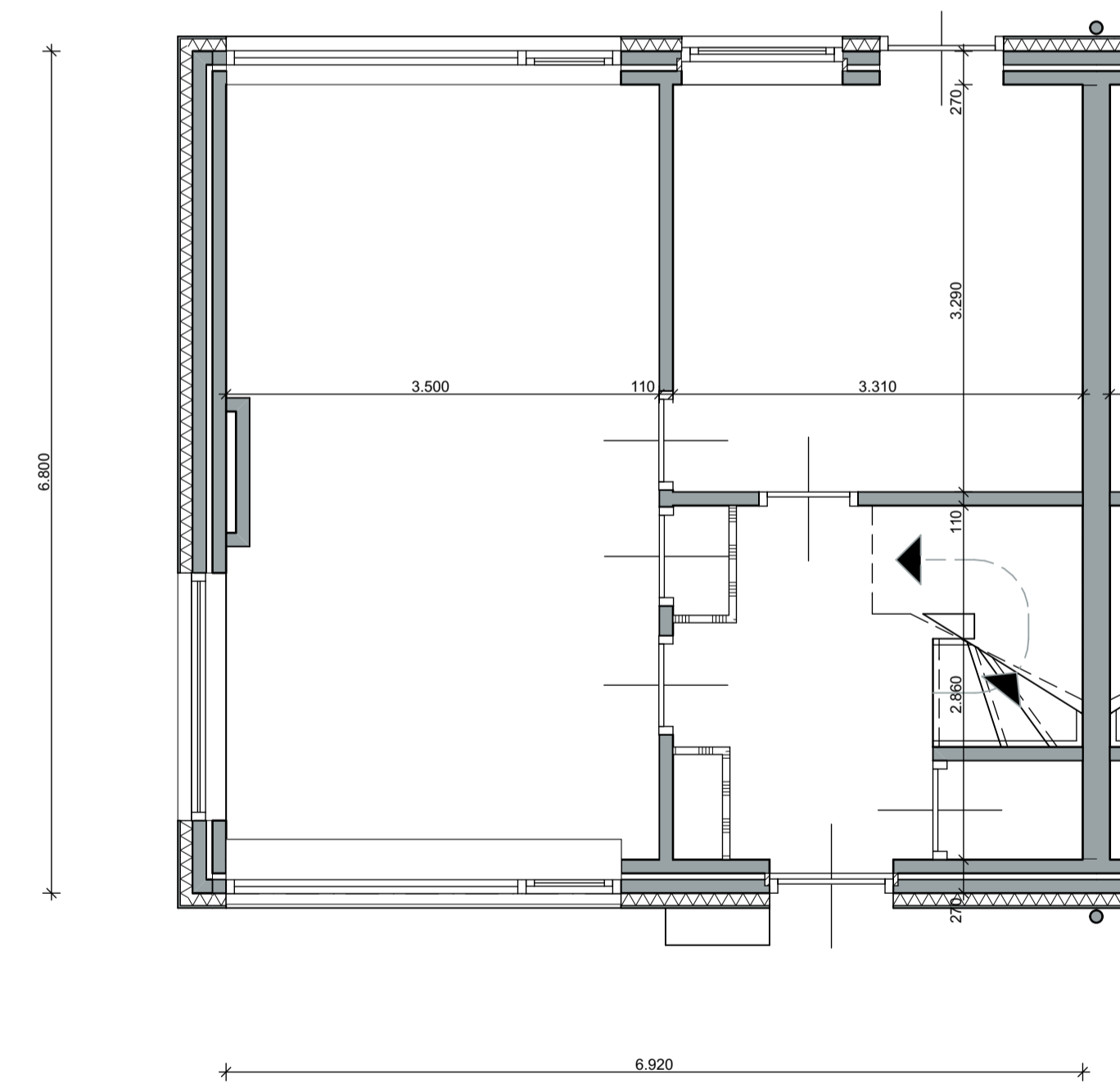

Begane grond 1/50

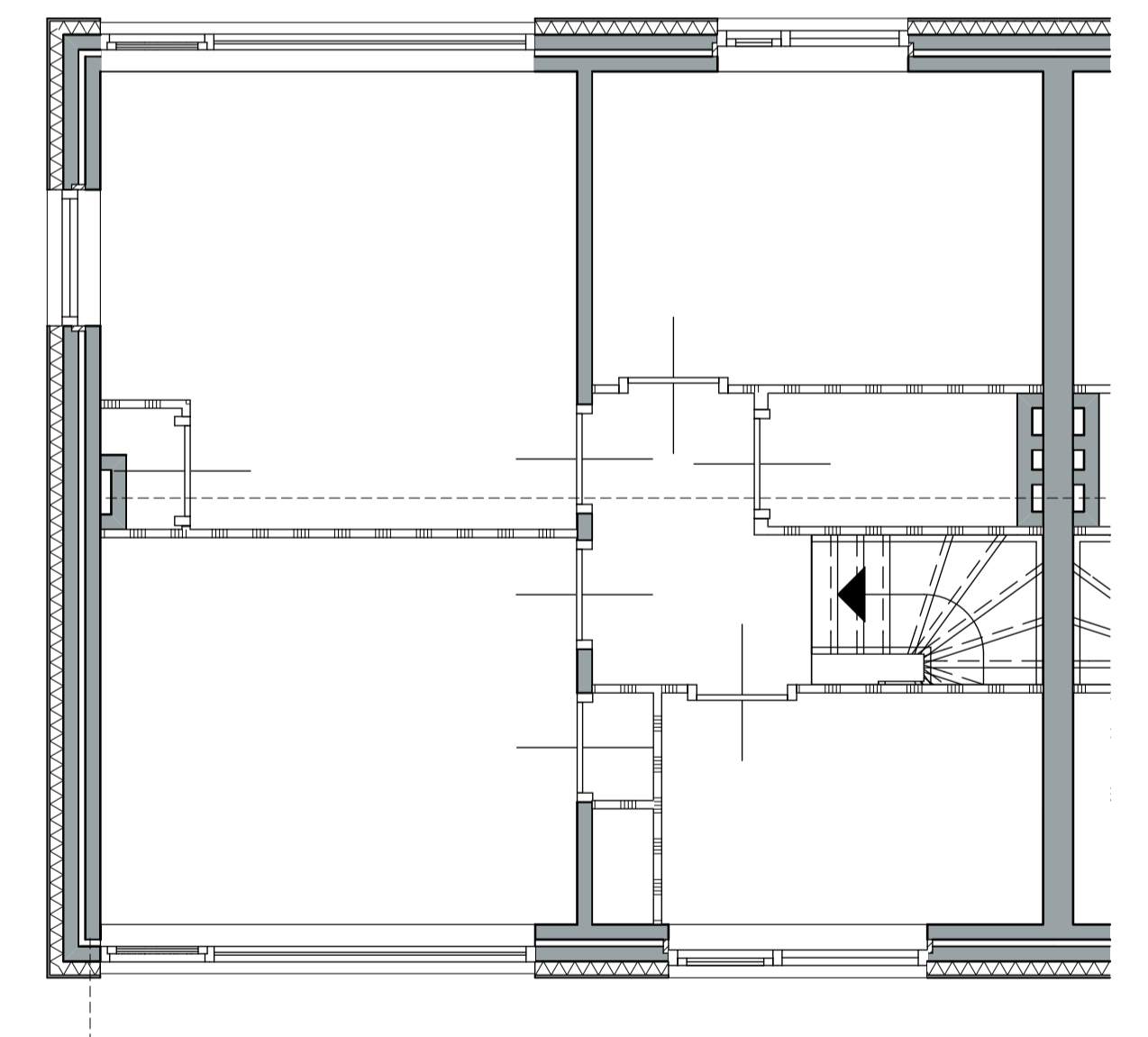

1e verdieping 1/50

VANSCHAGEN ARCHITECTEN

W1593 | planmatig onderhoud 10 woningen
De Ruyterstraat Dinteloord
gevelrenovatie

Overzichtstekening nieuwe situatie
Gewijzigd: 9-9-2015
Schaal: 1/100, 1/50
Formaat: A1