

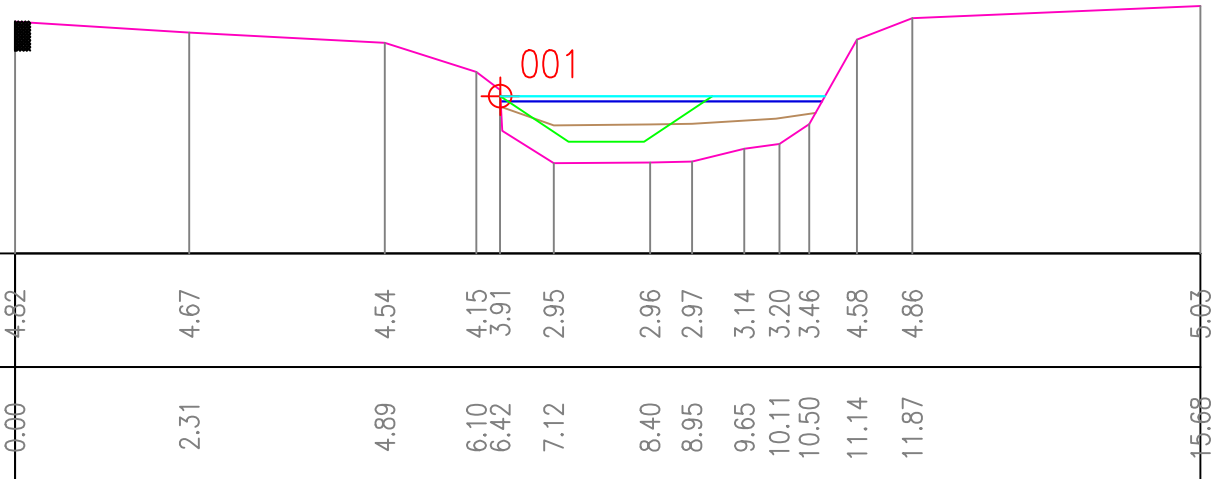

Nulpunt 1.75 +NAP



Oprachtgever		 HOOGHEEMRAADSCHAP DE STICHTSE RIJNLANDEN		Postbus 550 3990 GJ Houten Tel.: (030) 634 57 00 Fax: (030) 634 59 98		Poldermolen 2 3994 DD Houten e-mail: post@hdsr.nl www.destichtserijnlanden.nl	
Project							
Herprofilering Gooyerwetering							
Onderdeel							
ontwerp-profiel							
Projectnr. 401024		Besteknr(s).		Documentnr.		Status concept	
Formaat A4	Schaal 1:100	Getek. D.S.	Datum 9-7-2014	Goedgek.	Akk.	Tek.nr. 1	Versie 1

Nulpunt 1.75 +NAP

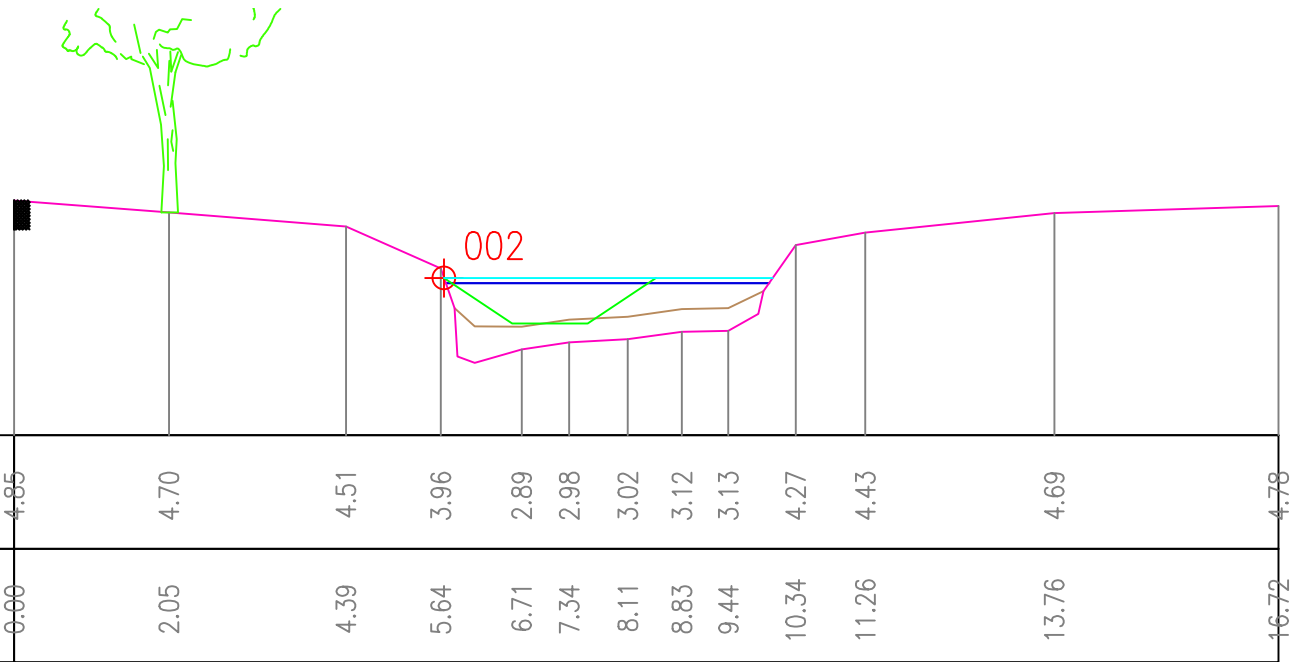

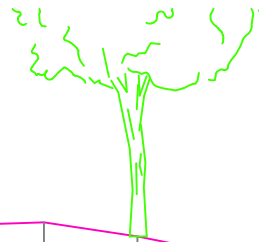

Opdrachtgever		 HOOGHEEMRAADSCHAP DE STICHTSE RIJNLANDEN		Postbus 550 3990 GJ Houten		Poldermolen 2 3994 DD Houten	
Project		Herprofilering Gooyerwetering					
Onderdeel		ontwerp-profiel					
Projectnr.	401024	Besteknr(s).		Documentnr.		Status	concept
Formaat	A4	Schaal	1:100	Getek.	D.S.	Datum	9-7-2014
Goedgek.		Akk.		Tek.nr.	2	Versie	1

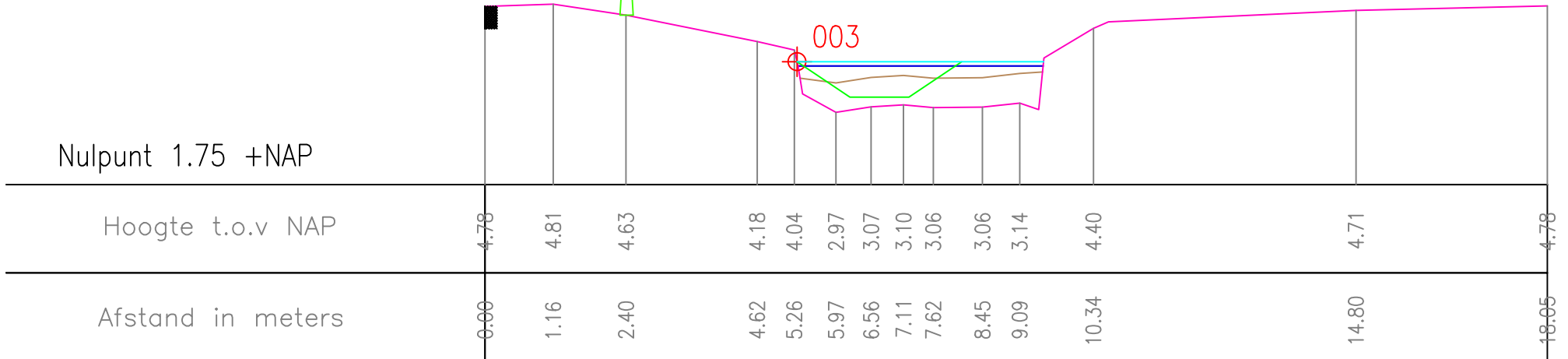

003

Nulpunt 1.75 +NAP



Opdrachtgever	 HOOGHEEMRAADSCHAP DE STICHTSE RIJNLANDEN	Postbus 550 3990 GJ Houten	Poldermolen 2 3994 DD Houten
Project		Tel.: (030) 634 57 00 Fax: (030) 634 59 98	e-mail: post@hdsr.nl www.destichtserijnlanden.nl

Herprofilering Gooyerwetering

Onderdeel
ontwerp-profiel

Projectnr. 401024	Besteknr(s).	Documentnr.	Status concept
Formaat A4	Schaal 1:100	Getek. D.S.	Datum 9-7-2014
Goedgek.	Akk.	Tek.nr. 3	Versie 1

Nulpunt 1.75 +NAP

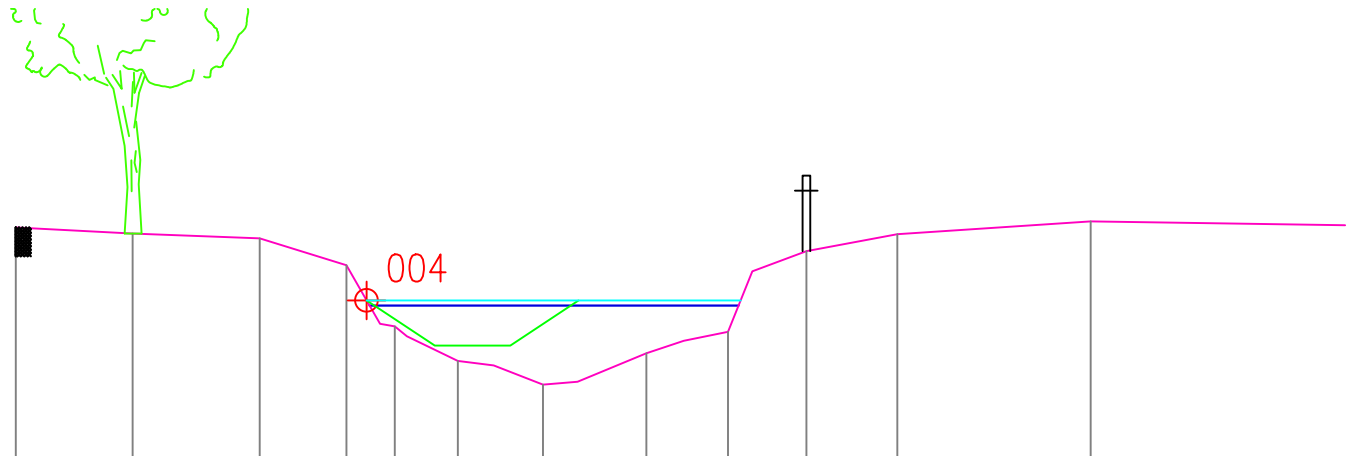

Hoogte t.o.v NAP	4.80	4.72	4.65	4.30	3.49	3.03	2.72	3.13	3.42	4.48	4.71	4.88
Afstand in meters	0.00	1.54	3.22	4.37	5.01	5.85	6.97	8.34	9.42	10.46	11.66	14.22

Oprachtgever	 HOOGHEEMRAADSCHAP DE STICHTSE RIJNLANDEN	Postbus 550 3990 GJ Houten	Poldermolen 2 3994 DD Houten
Project		Tel.: (030) 634 57 00 Fax: (030) 634 59 98	e-mail: post@hdsr.nl www.destichtserijnlanden.nl

Herprofilering Gooyerwetering

Onderdeel
ontwerp-profiel

Projectnr.	401024	Besteknr(s).	Documentnr.	Status	concept								
Formaat	A4	Schaal	1:100	Getek.	D.S.	Datum	9-7-2014	Goedgek.	Akk.	Tek.nr.	4	Versie	1

Nulpunt 2.75 +NAP

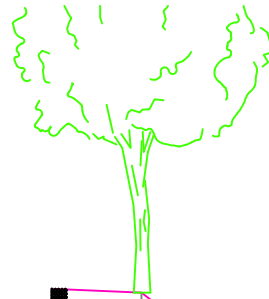



005

Hoogte t.o.v NAP	4.74	4.69	4.02	3.56	3.54	4.80	5.12
Afstand in meters	0.00	1.18	2.06	2.71	3.44	6.23	9.66

Opdrachtgever		 HOOGHEEMRAADSCHAP DE STICHTSE RIJNLANDEN	Postbus 550 3990 GJ Houten	Poldermolen 2 3994 DD Houten
Project			Tel.: (030) 634 57 00 Fax: (030) 634 59 98	e-mail: post@hdsr.nl www.destichtserijnlanden.nl
Herprofilering Gooyerwetering Onderdeel ontwerp-profiel				
Projectnr.	401024	Besteknr(s).	Documentnr.	Status concept
Formaat A4	Schaal 1:100	Getek. D.S.	Datum 9-7-2014	Goedgek. Akk. Tek.nr. 5 Versie 1

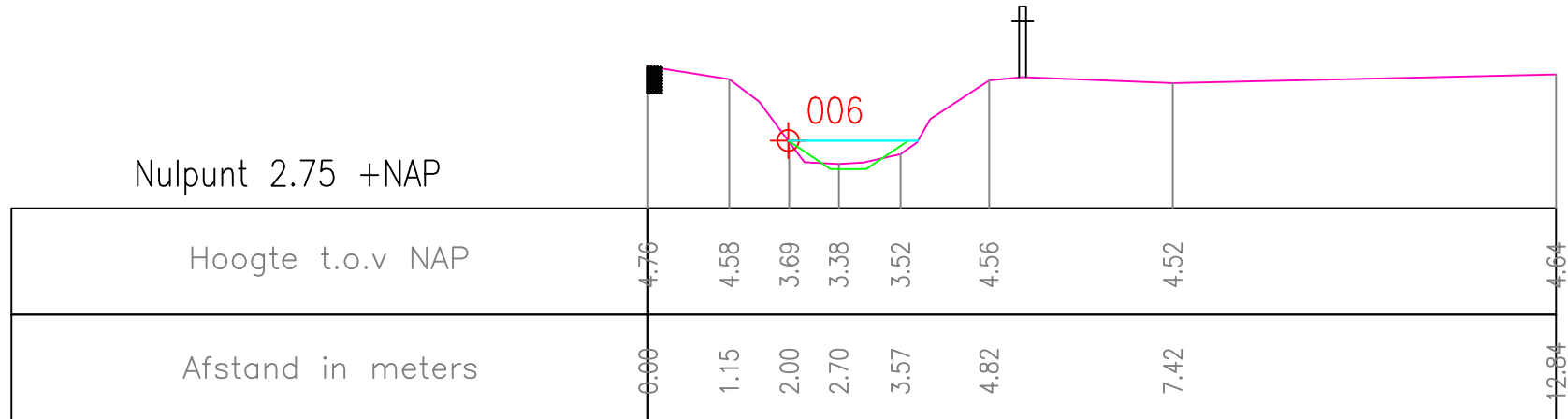
Nulpunt 2.75 +NAP



Oprachtgever		 HOOGHEEMRAADSCHAP DE STICHTSE RIJNLANDEN		Postbus 550 3990 GJ Houten Tel.: (030) 634 57 00 Fax: (030) 634 59 98		Poldermolen 2 3994 DD Houten e-mail: post@hdsr.nl www.destichtserijnlanden.nl	
Project							
Herprofilering Gooyerwetering							
Onderdeel							
ontwerp-profiel							
Projectnr.		Besteknr(s).		Documentnr.		Status	
401024						concept	
Formaat	Schaal	Getek.	Datum	Goedgek.	Akk.	Tek.nr.	Versie
A4	1:100	D.S.	9-7-2014			6	1

Nulpunt 2.75 +NAP

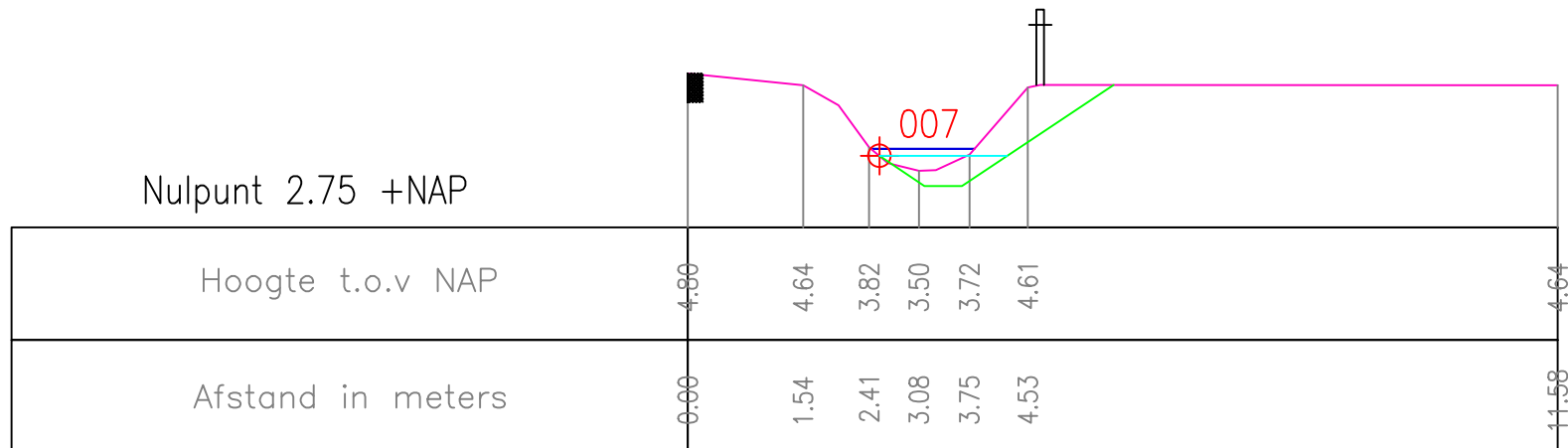

Oprachtgever		 HOOGHEEMRAADSCHAP DE STICHTSE RIJNLANDEN		Postbus 550 3990 GJ Houten		Poldermolen 2 3994 DD Houten	
Project		Herprofilering Gooyerwetering					
Onderdeel		ontwerp-profiel					
Projectnr.	401024	Besteknr(s).		Documentnr.		Status	concept
Formaat	A4	Schaal	1:100	Getek.	D.S.	Datum	9-7-2014
		Goedgek.		Akk.		Tek.nr.	7
						Versie	1

Nulpunt 2.75 +NAP

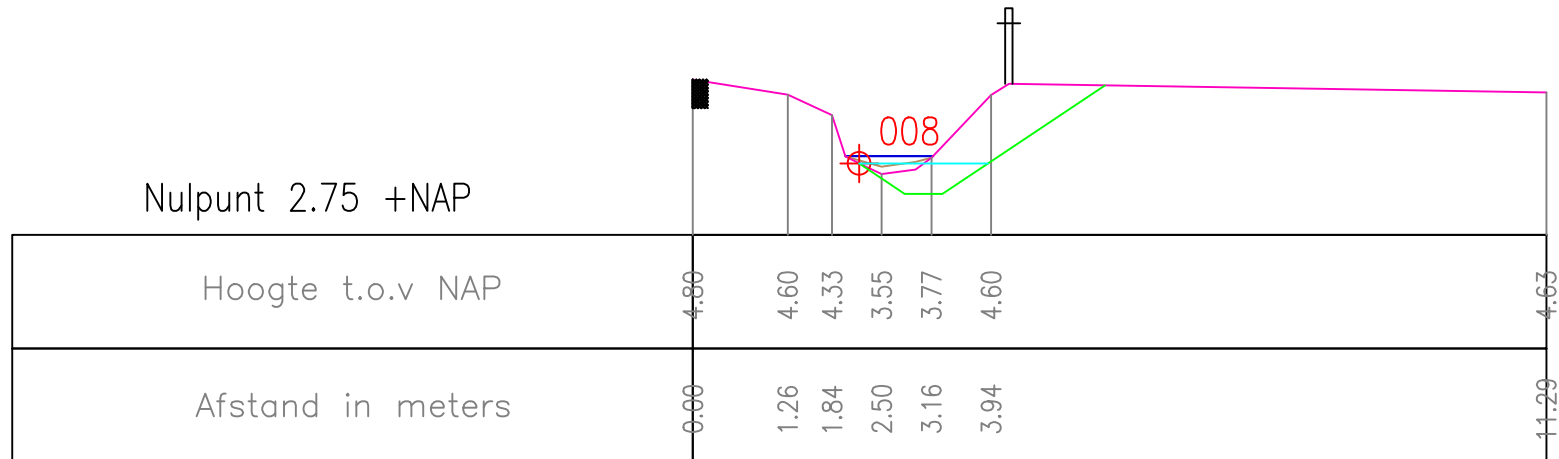

Oprachtgever		 HOOGHEEMRAADSCHAP DE STICHTSE RIJNLANDEN	Postbus 550 3990 GJ Houten	Poldermolen 2 3994 DD Houten
Project			Tel.: (030) 634 57 00 Fax: (030) 634 59 98	e-mail: post@hdsr.nl www.destichtserijnlanden.nl
Herprofilering Gooyerwetering Onderdeel ontwerp-profiel				
Projectnr.	401024	Besteknr(s).	Documentnr.	Status concept
Formaat A4	Schaal 1:100	Getek. D.S.	Datum 9-7-2014	Goedgek. Akk. Tek.nr. 8 Versie 1

Nulpunt 2.75 +NAP

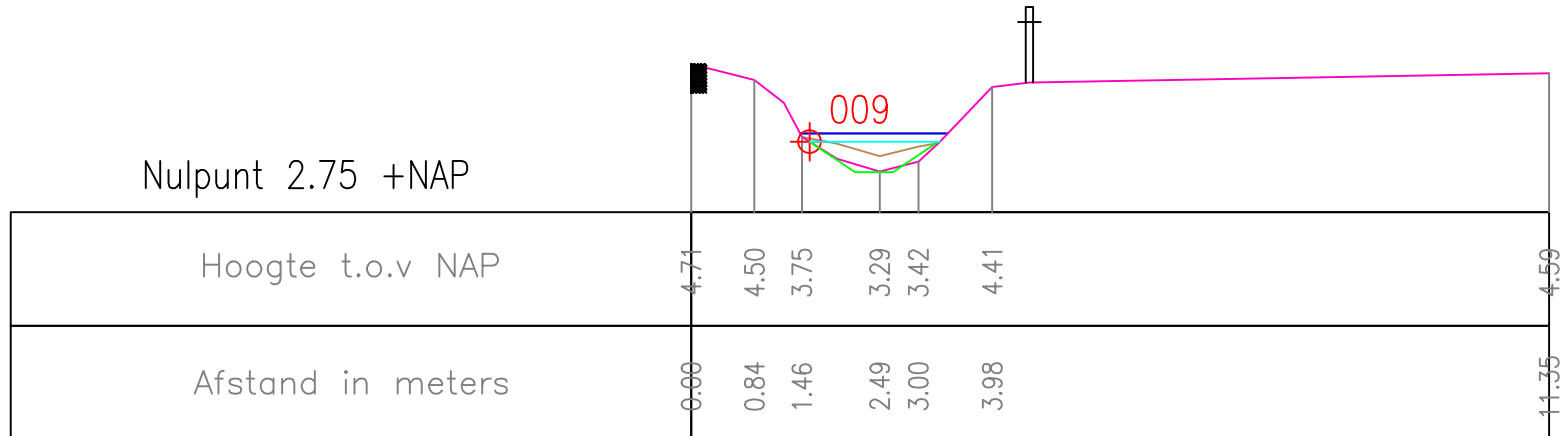

Opdrachtgever		 HOOGHEEMRAADSCHAP DE STICHTSE RIJNLANDEN	Postbus 550 3990 GJ Houten	Poldermolen 2 3994 DD Houten
Project			Tel.: (030) 634 57 00 Fax: (030) 634 59 98	e-mail: post@hdsr.nl www.destichtserijnlanden.nl
Herprofilering Gooyerwetering Onderdeel ontwerp-profiel				
Projectnr.	401024	Besteknr(s).	Documentnr.	Status concept
Formaat A4	Schaal 1:100	Getek. D.S.	Datum 9-7-2014	Goedgek. Akk. Tek.nr. 9 Versie 1

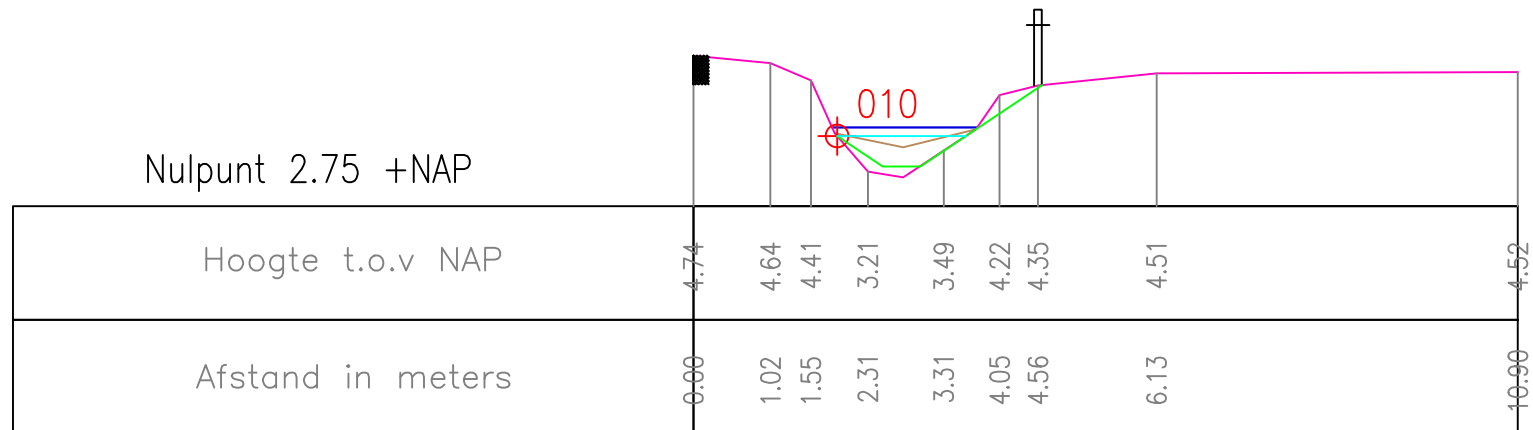

Opdrachtgever		 HOOGHEEMRAADSCHAP DE STICHTSE RIJNLANDEN	Postbus 550 3990 GJ Houten	Poldermolen 2 3994 DD Houten
Project			Tel.: (030) 634 57 00 Fax: (030) 634 59 98	e-mail: post@hdsr.nl www.destichtserijnlanden.nl
Herprofilering Gooyerwetering Onderdeel ontwerp-profiel				
Projectnr.	401024	Besteknr(s).	Documentnr.	Status concept
Formaat A4	Schaal 1:100	Getek. D.S.	Datum 9-7-2014	Goedgek. Akk. Tek.nr. 10
				Versie 1

Nulpunt 2.75 +NAP

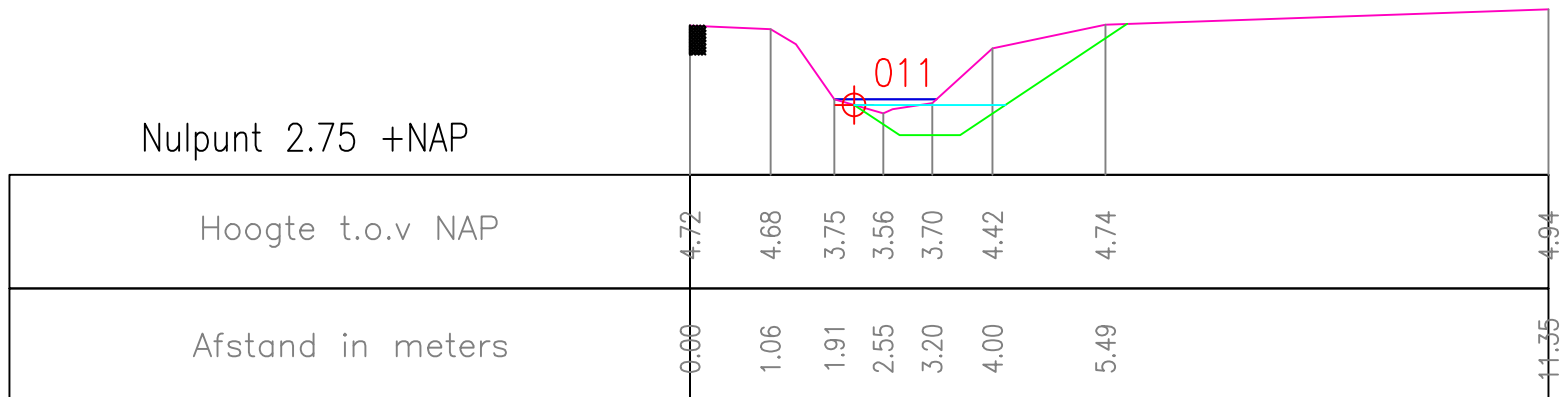

Oprachtgever		 HOOGHEEMRAADSCHAP DE STICHTSE RIJNLANDEN	Postbus 550 3990 GJ Houten	Poldermolen 2 3994 DD Houten
Project			Tel.: (030) 634 57 00 Fax: (030) 634 59 98	e-mail: post@hdsr.nl www.destichtserijnlanden.nl
Herprofilering Gooyerwetering ontwerp-profiel				
Projectnr.	401024	Besteknr(s).	Documentnr.	Status concept
Formaat A4	Schaal 1:100	Getek. D.S.	Datum 9-7-2014	Goedgek. Akk. Tek.nr. 11
				Versie 1

Nulpunt 2.75 +NAP

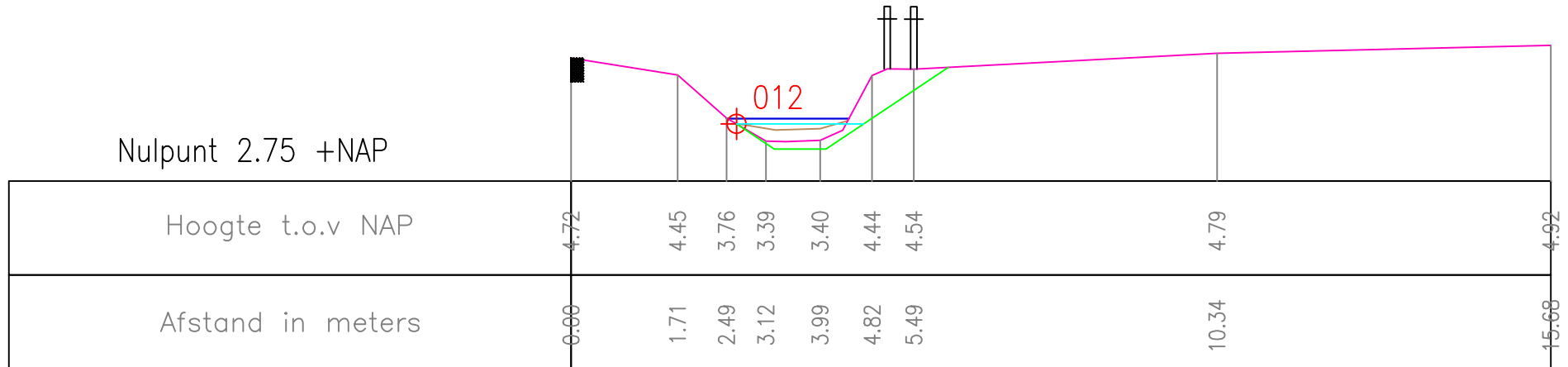

Oprachtgever		 HOOGHEEMRAADSCHAP DE STICHTSE RIJNLANDEN	Postbus 550 3990 GJ Houten	Poldermolen 2 3994 DD Houten
Project			Tel.: (030) 634 57 00 Fax: (030) 634 59 98	e-mail: post@hdsr.nl www.destichtserijnlanden.nl
Herprofilering Gooyerwetering Onderdeel ontwerp-profiel				
Projectnr.	401024	Besteknr(s).	Documentnr.	Status concept
Formaat A4	Schaal 1:100	Getek. D.S.	Datum 9-7-2014	Goedgek. Akk. Tek.nr. 12
				Versie 1

Nulpunt 2.75 +NAP

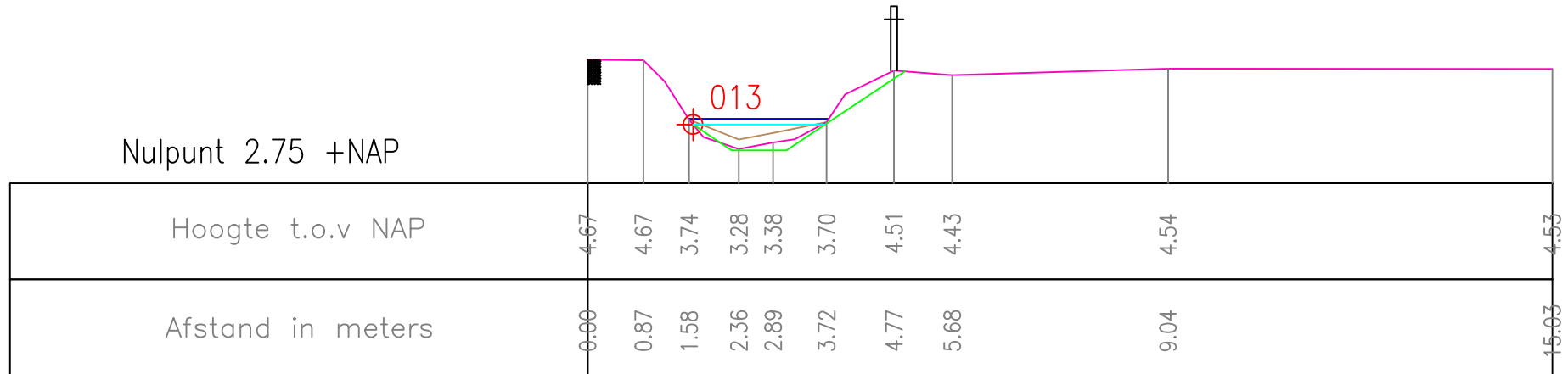

Oprachtgever		 HOOGHEEMRAADSCHAP DE STICHTSE RIJNLANDEN	Postbus 550 3990 GJ Houten	Poldermolen 2 3994 DD Houten
Project			Tel.: (030) 634 57 00 Fax: (030) 634 59 98	e-mail: post@hdsr.nl www.destichtserijnlanden.nl
<p>Herprofilering Gooyerwetering</p> <p>Onderdeel ontwerp-profiel</p>				
Projectnr.	401024	Besteknr(s).	Documentnr.	Status concept
Formaat A4	Schaal 1:100	Getek. D.S.	Datum 9-7-2014	Goedgek. Akk. Tek.nr. 13
				Versie 1

Nulpunt 2.75 +NAP

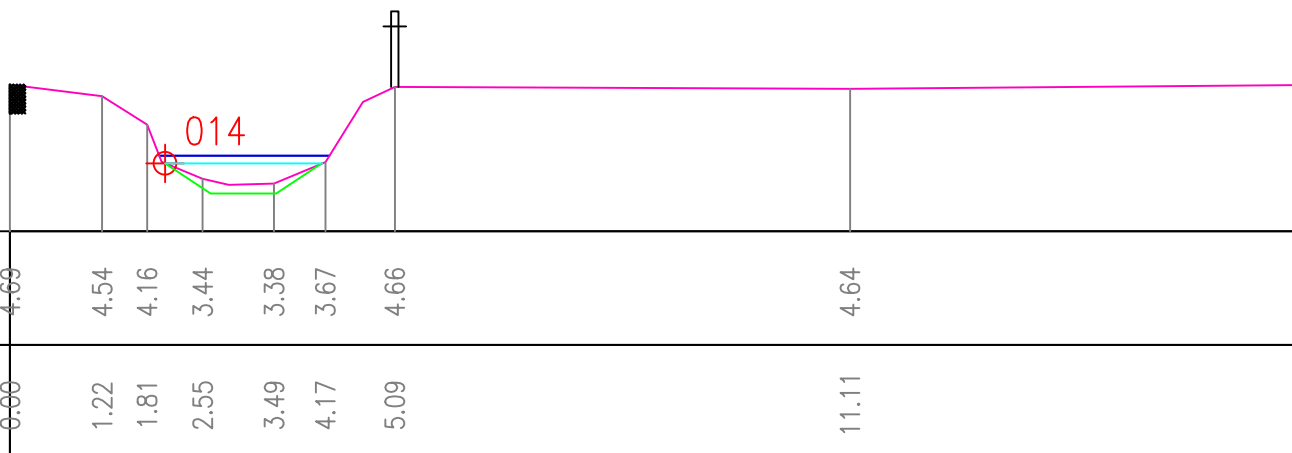

Oprachtgever		 HOOGHEEMRAADSCHAP DE STICHTSE RIJNLANDEN	Postbus 550 3990 GJ Houten		Poldermolen 2 3994 DD Houten	
			Tel.: (030) 634 57 00 Fax: (030) 634 59 98		e-mail: post@hdsr.nl www.destichtserijnlanden.nl	
Project						
Herprofilering Gooyerwetering						
Onderdeel						
ontwerp-profiel						
Projectnr. 401024		Besteknr(s).		Documentnr.		Status concept
Formaat A4	Schaal 1:100	Getek. D.S.	Datum 9-7-2014	Goedgek.	Akk.	Tek.nr. 14
						Versie 1

Nulpunt 2.75 +NAP

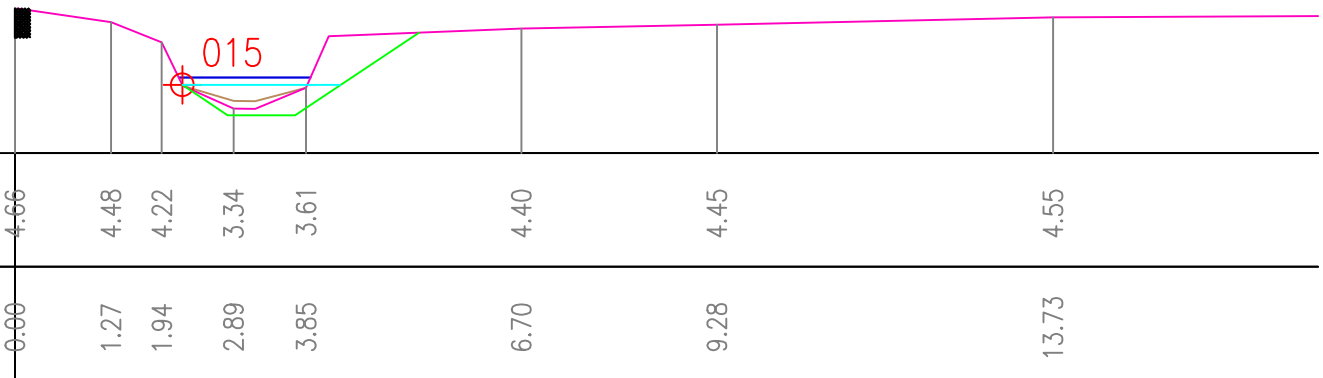

Oprachtgever		 HOOGHEEMRAADSCHAP DE STICHTSE RIJNLANDEN	Postbus 550 3990 GJ Houten	Poldermolen 2 3994 DD Houten									
Project			Tel.: (030) 634 57 00 Fax: (030) 634 59 98	e-mail: post@hdsr.nl www.destichtserijnlanden.nl									
Herprofilering Gooyerwetering Onderdeel ontwerp-profiel													
Projectnr.	401024	Besteknr(s).	Documentnr.	Status concept									
Formaat	A4	Schaal	1:100	Getek.	D.S.	Datum	9-7-2014	Goedgek.	Akk.	Tek.nr.	15	Versie	1

Nulpunt 2.75 +NAP

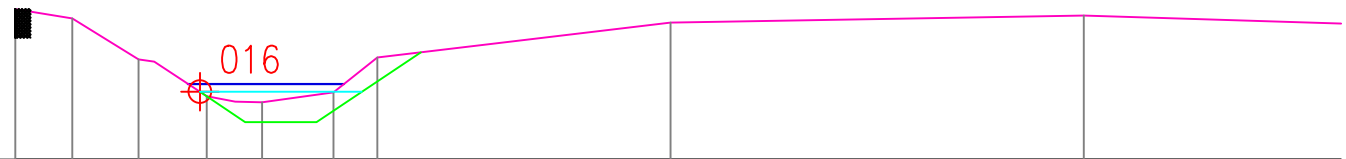

Hoogte t.o.v NAP	4.74	4.62	4.07	3.59	3.50	3.64	4.10	4.56	4.65
Afstand in meters	0.00	0.76	1.63	2.53	3.26	4.21	4.79	8.66	14.13

Oprachtgever		 HOOGHEEMRAADSCHAP DE STICHTSE RIJNLANDEN	Postbus 550 3990 GJ Houten	Poldermolen 2 3994 DD Houten									
Project			Tel.: (030) 634 57 00 Fax: (030) 634 59 98	e-mail: post@hdsr.nl www.destichtserijnlanden.nl									
Herprofilering Gooyerwetering Onderdeel ontwerp-profiel													
Projectnr.	401024	Besteknr(s).	Documentnr.	Status concept									
Formaat	A4	Schaal	1:100	Getek.	D.S.	Datum	9-7-2014	Goedgek.	Akk.	Tek.nr.	16	Versie	1

Nulpunt 2.75 +NAP

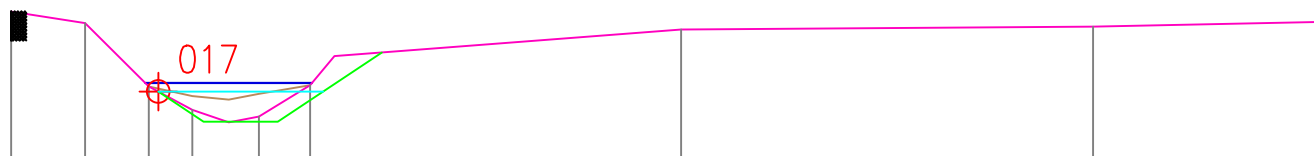

Hoogte t.o.v NAP	4.69	4.54	3.70	3.40	3.30	3.72	4.45	4.49
Afstand in meters	0.00	0.98	1.82	2.39	3.28	3.96	8.86	14.31

Oprichtgever		 HOOGHEEMRAADSCHAP DE STICHTSE RIJNLANDEN	Postbus 550 3990 GJ Houten	Poldermolen 2 3994 DD Houten									
Project			Tel.: (030) 634 57 00 Fax: (030) 634 59 98	e-mail: post@hdsr.nl www.destichtserijnlanden.nl									
Herprofilering Gooyerwetering Onderdeel ontwerp-profiel													
Projectnr.	401024	Besteknr(s).	Documentnr.	Status concept									
Formaat	A4	Schaal	1:100	Getek.	D.S.	Datum	9-7-2014	Goedgek.	Akk.	Tek.nr.	17	Versie	1

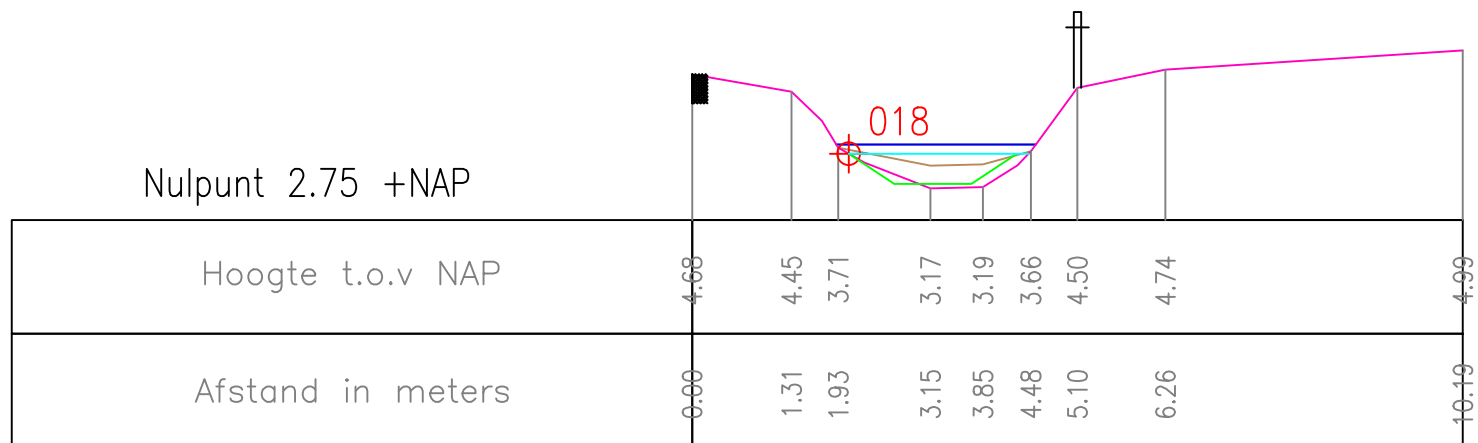

Opdrachtgever		 HOOGHEEMRAADSCHAP DE STICHTSE RIJNLANDEN	Postbus 550 3990 GJ Houten	Poldermolen 2 3994 DD Houten									
Project			Tel.: (030) 634 57 00 Fax: (030) 634 59 98	e-mail: post@hdsr.nl www.destichtserijnlanden.nl									
Herprofilering Gooyerwetering Onderdeel ontwerp-profiel													
Projectnr.	401024	Besteknr(s).	Documentnr.	Status concept									
Formaat	A4	Schaal	1:100	Getek.	D.S.	Datum	9-7-2014	Goedgek.	Akk.	Tek.nr.	18	Versie	1

Nulpunt 2.75 +NAP

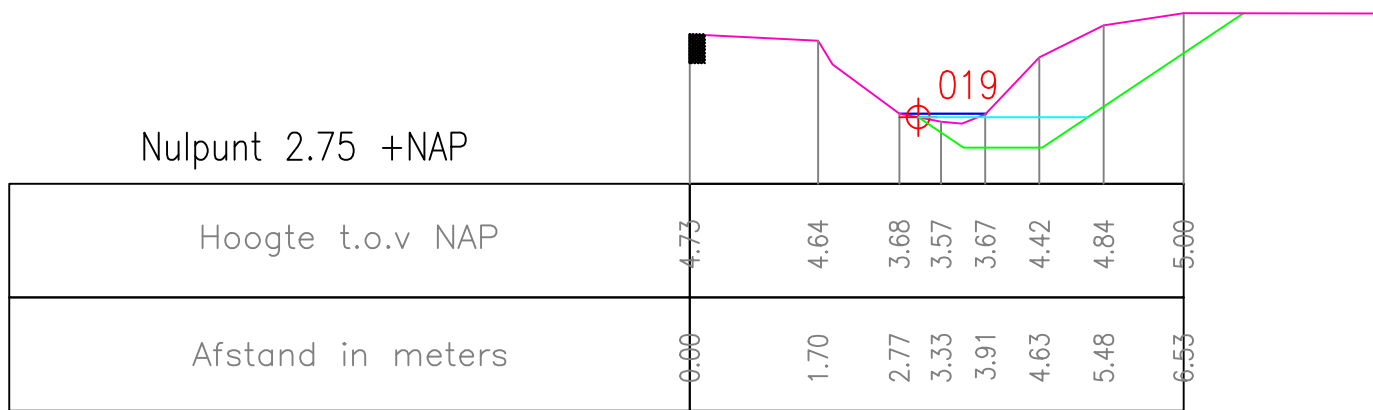

Oprachtgever		 HOOGHEEMRAADSCHAP DE STICHTSE RIJNLANDEN	Postbus 550 3990 GJ Houten	Poldermolen 2 3994 DD Houten									
Project			Tel.: (030) 634 57 00 Fax: (030) 634 59 98	e-mail: post@hdsr.nl www.destichtserijnlanden.nl									
Herprofilering Gooyerwetering Onderdeel ontwerp-profiel													
Projectnr.	401024	Besteknr(s).	Documentnr.	Status concept									
Formaat	A4	Schaal	1:100	Getek.	D.S.	Datum	9-7-2014	Goedgek.	Akk.	Tek.nr.	19	Versie	1

Nulpunt 2.75 +NAP

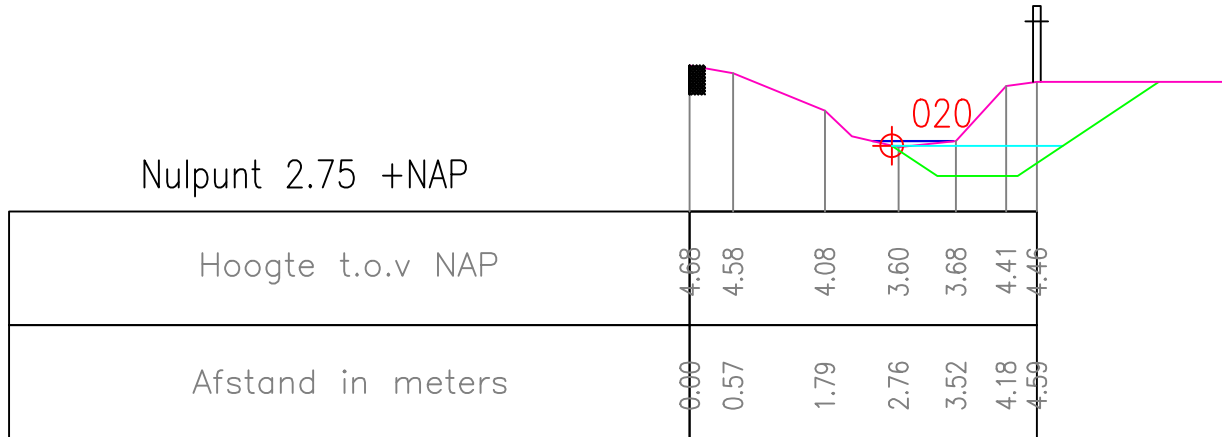

Oprachtgever		 HOOGHEEMRAADSCHAP DE STICHTSE RIJNLANDEN	Postbus 550 3990 GJ Houten	Poldermolen 2 3994 DD Houten									
Project			Tel.: (030) 634 57 00 Fax: (030) 634 59 98	e-mail: post@hdsr.nl www.destichtserijnlanden.nl									
Herprofilering Gooyerwetering Onderdeel ontwerp-profiel													
Projectnr.	401024	Besteknr(s).	Documentnr.	Status concept									
Formaat	A4	Schaal	1:100	Getek.	D.S.	Datum	9-7-2014	Goedgek.	Akk.	Tek.nr.	20	Versie	1

Nulpunt 2.75 +NAP

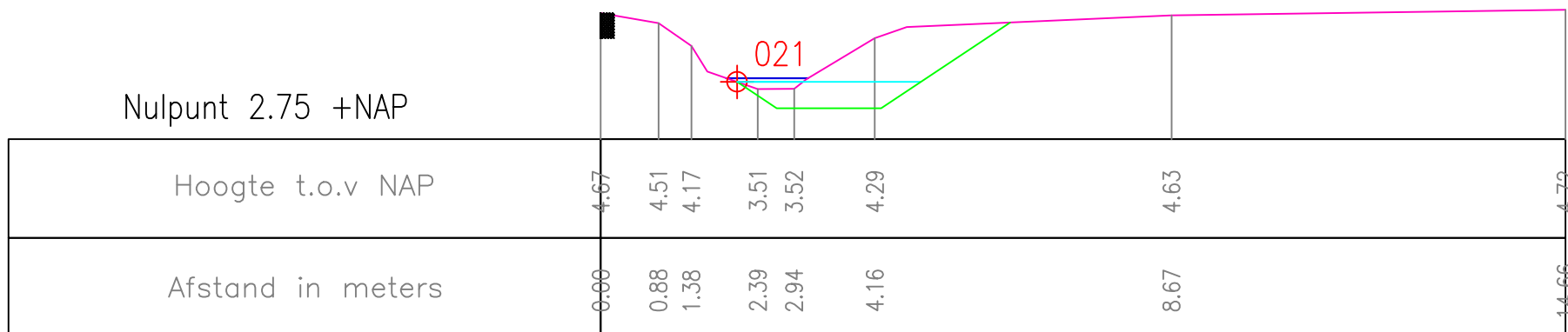

Opdrachtgever		 HOOGHEEMRAADSCHAP DE STICHTSE RIJNLANDEN	Postbus 550 3990 GJ Houten		Poldermolen 2 3994 DD Houten								
Project			Tel.: (030) 634 57 00 Fax: (030) 634 59 98		e-mail: post@hdsr.nl www.destichtserijnlanden.nl								
Herprofilering Gooyerwetering Onderdeel ontwerp-profiel													
Projectnr.	401024	Besteknr(s).	Documentnr.		Status concept								
Formaat	A4	Schaal	1:100	Getek.	D.S.	Datum	9-7-2014	Goedgek.	Akk.	Tek.nr.	21	Versie	1

Nulpunt 2.75 +NAP

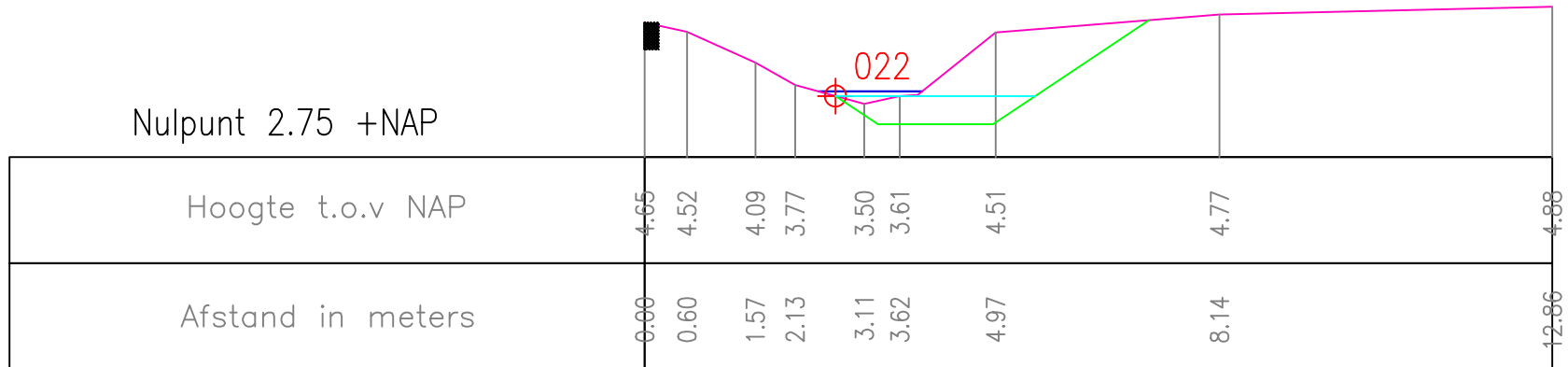

Oprachtgever		 HOOGHEEMRAADSCHAP DE STICHTSE RIJNLANDEN	Postbus 550 3990 GJ Houten		Poldermolen 2 3994 DD Houten		
Project			Tel.: (030) 634 57 00 Fax: (030) 634 59 98		e-mail: post@hdsr.nl www.destichtserijnlanden.nl		
Project <h2>Herprofilering Gooyerwetering</h2> Onderdeel <h3>ontwerp-profiel</h3>							
Projectnr.		Besteknr(s).		Documentnr.		Status	
401024						concept	
Formaat	Schaal	Getek.	Datum	Goedgek.	Akk.	Tek.nr.	Versie
A4	1:100	D.S.	9-7-2014			22	1

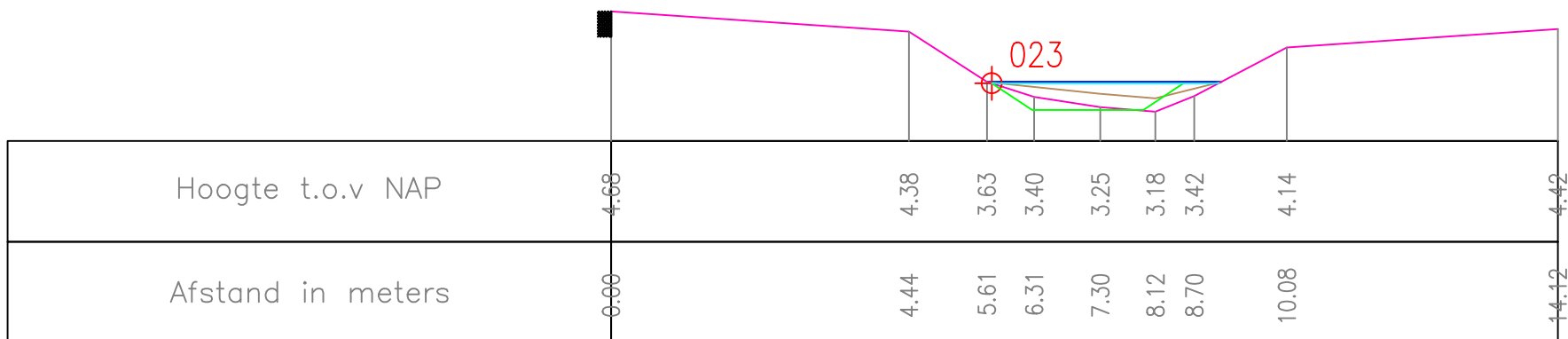

Oprachtgever		 HOOGHEEMRAADSCHAP DE STICHTSE RIJNLANDEN	Postbus 550 3990 GJ Houten		Poldermolen 2 3994 DD Houten	
			Tel.: (030) 634 57 00 Fax: (030) 634 59 98		e-mail: post@hdsr.nl www.destichtserijnlanden.nl	
Project						
Herprofilering Gooyerwetering						
Onderdeel						
ontwerp-profiel						
Projectnr.		Besteknr(s).		Documentnr.		Status
401024						concept
Formaat	Schaal	Getek.	Datum	Goedgek.	Akk.	Tek.nr.
A4	1:100	D.S.	9-7-2014			23
						Versie
						1

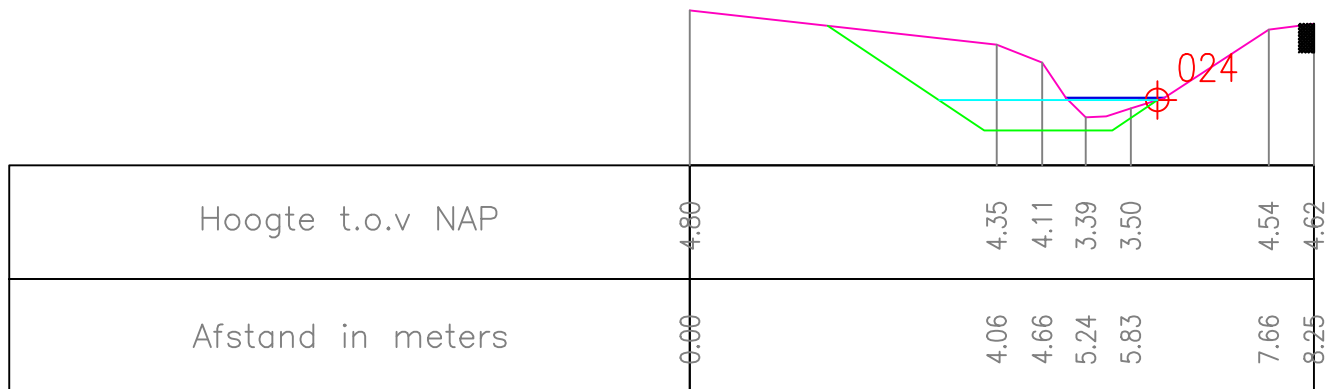

Oprachtgever		 HOOGHEEMRAADSCHAP DE STICHTSE RIJNLANDEN	Postbus 550 3990 GJ Houten	Poldermolen 2 3994 DD Houten									
Project			Tel.: (030) 634 57 00 Fax: (030) 634 59 98	e-mail: post@hdsr.nl www.destichtserijnlanden.nl									
Herprofilering Gooyerwetering Onderdeel ontwerp-profiel													
Projectnr.	401024	Besteknr(s).	Documentnr.	Status concept									
Formaat	A4	Schaal	1:100	Getek.	D.S.	Datum	9-7-2014	Goedgek.	Akk.	Tek.nr.	24	Versie	1

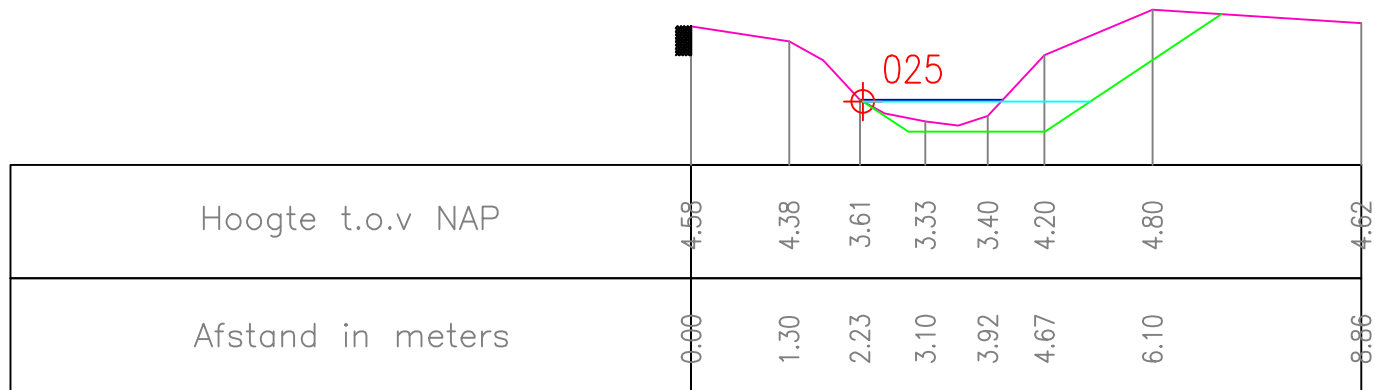

Oprachtgever		 HOOGHEEMRAADSCHAP DE STICHTSE RIJNLANDEN	Postbus 550 3990 GJ Houten	Poldermolen 2 3994 DD Houten
Project			Tel.: (030) 634 57 00 Fax: (030) 634 59 98	e-mail: post@hdsr.nl www.destichtserijnlanden.nl
Herprofilering Gooyerwetering ontwerp-profiel				
Projectnr.	401024	Besteknr(s).	Documentnr.	Status concept
Formaat A4	Schaal 1:100	Getek. D.S.	Datum 9-7-2014	Goedgek. Akk. Tek.nr. 25 Versie 1

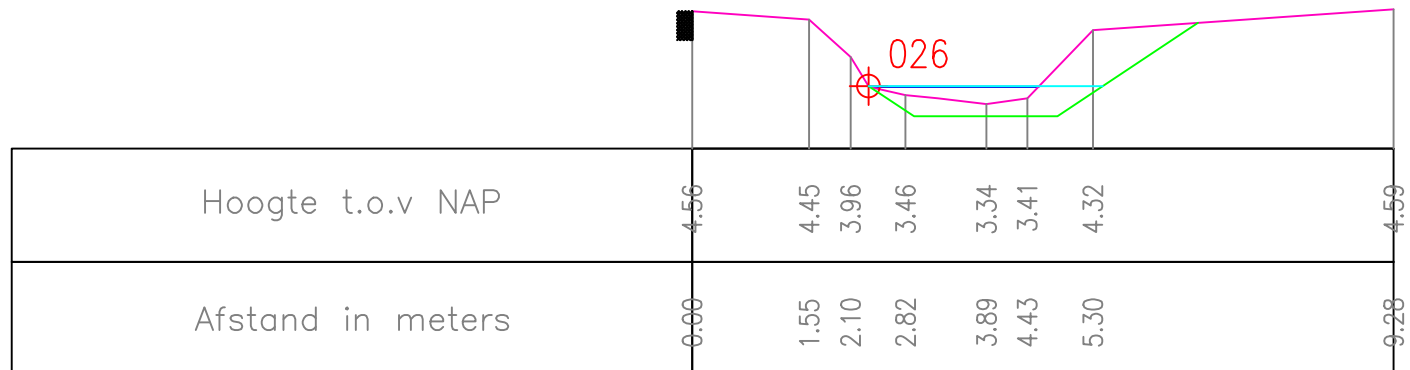

Oprachtgever		 HOOGHEEMRAADSCHAP DE STICHTSE RIJNLANDEN	Postbus 550 3990 GJ Houten	Poldermolen 2 3994 DD Houten									
Project			Tel.: (030) 634 57 00 Fax: (030) 634 59 98	e-mail: post@hdsr.nl www.destichtserijnlanden.nl									
Herprofilering Gooyerwetering													
Onderdeel ontwerp-profiel													
Projectnr.	401024	Besteknr(s).	Documentnr.	Status concept									
Formaat	A4	Schaal	1:100	Getek.	D.S.	Datum	9-7-2014	Goedgek.	Akk.	Tek.nr.	26	Versie	1

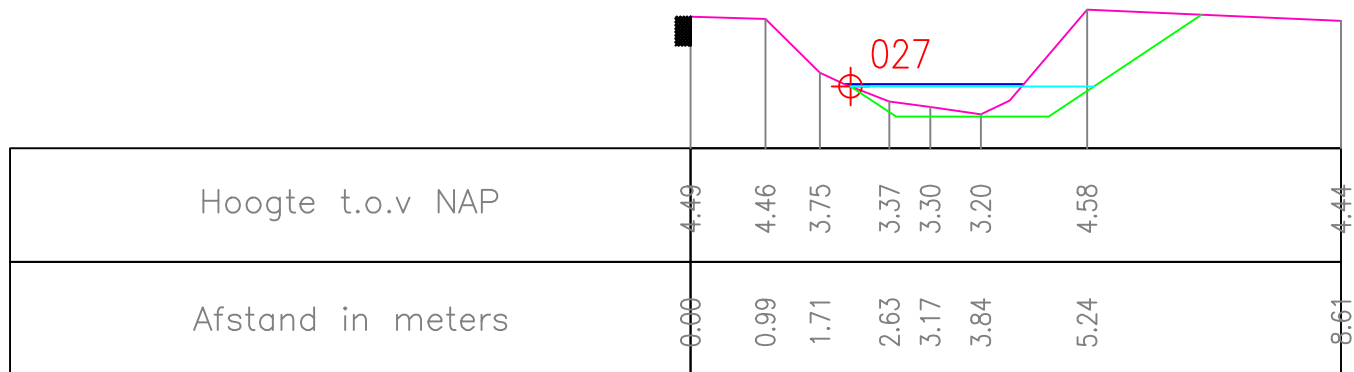

Oprachtgever		 HOOGHEEMRAADSCHAP DE STICHTSE RIJNLANDEN		Postbus 550 3990 GJ Houten		Poldermolen 2 3994 DD Houten	
				Tel.: (030) 634 57 00		e-mail: post@hdsr.nl	
				Fax: (030) 634 59 98		www.destichtserijnlanden.nl	
Project							
Herprofilering Gooyerwetering							
Onderdeel							
ontwerp-profiel							
Projectnr.		Besteknr(s).		Documentnr.		Status	
401024						concept	
Formaat	Schaal	Getek.	Datum	Goedgek.	Akk.	Tek.nr.	Versie
A4	1:100	D.S.	9-7-2014			27	1

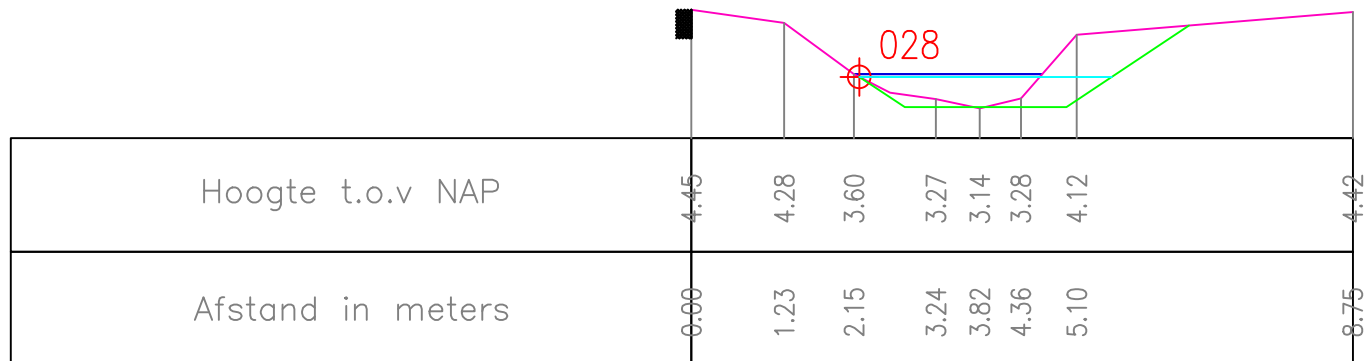

Oprichtgever		 HOOGHEEMRAADSCHAP DE STICHTSE RIJNLANDEN	Postbus 550 3990 GJ Houten	Poldermolen 2 3994 DD Houten									
Project			Tel.: (030) 634 57 00 Fax: (030) 634 59 98	e-mail: post@hdsr.nl www.destichtserijnlanden.nl									
Project <h2 style="text-align: center;">Herprofilering Gooyerwetering</h2>													
Onderdeel <h3 style="text-align: center;">ontwerp-profiel</h3>													
Projectnr.	401024	Besteknr(s).	Documentnr.	Status concept									
Formaat	A4	Schaal	1:100	Getek.	D.S.	Datum	9-7-2014	Goedgek.	Akk.	Tek.nr.	28	Versie	1

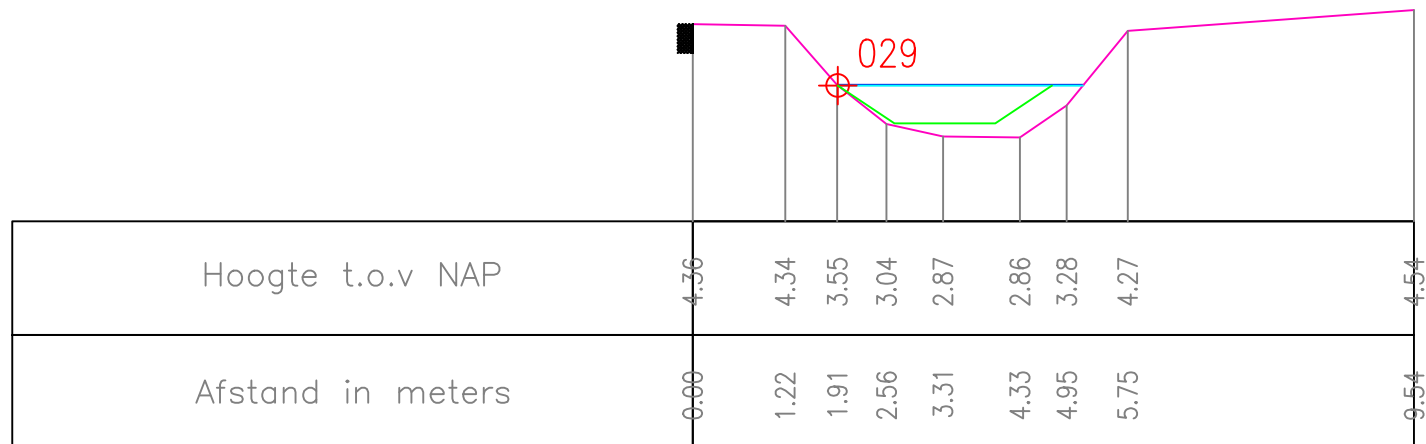

Oprachtgever		 HOOGHEEMRAADSCHAP DE STICHTSE RIJNLANDEN		Postbus 550 3990 GJ Houten		Poldermolen 2 3994 DD Houten	
Project		Herprofilering Gooyerwetering					
Onderdeel		ontwerp-profiel					
Projectnr.	401024	Besteknr(s).		Documentnr.		Status	concept
Formaat	A4	Schaal	1:100	Getek.	D.S.	Datum	9-7-2014
		Goedgek.		Akk.		Tek.nr.	29
						Versie	1

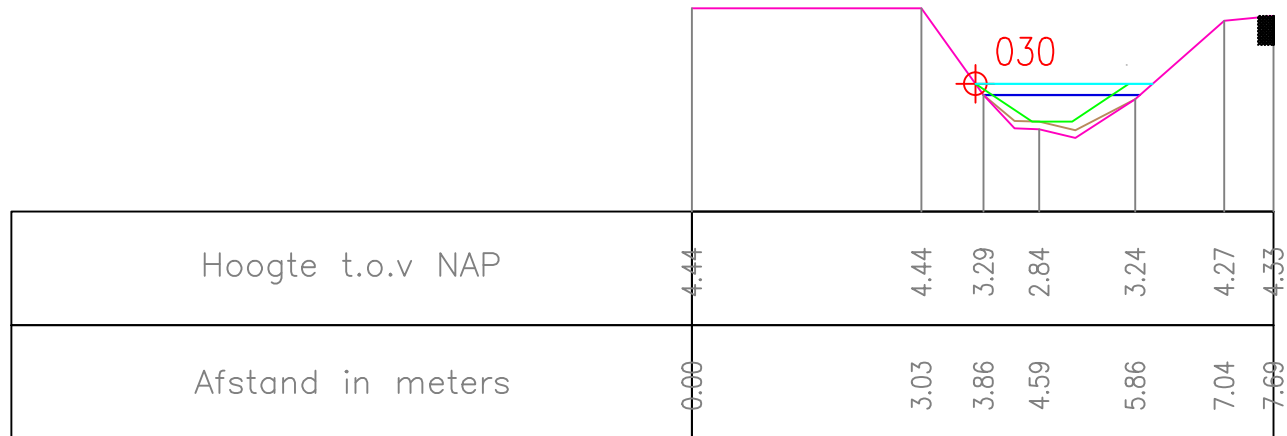

Oprachtgever		 HOOGHEEMRAADSCHAP DE STICHTSE RIJNLANDEN	Postbus 550 3990 GJ Houten	Poldermolen 2 3994 DD Houten									
Project			Tel.: (030) 634 57 00 Fax: (030) 634 59 98	e-mail: post@hdsr.nl www.destichtserijnlanden.nl									
Herprofilering Gooyerwetering Onderdeel ontwerp-profiel													
Projectnr.	401024	Besteknr(s).	Documentnr.	Status concept									
Formaat	A4	Schaal	1:100	Getek.	D.S.	Datum	9-7-2014	Goedgek.	Akk.	Tek.nr.	30	Versie	1

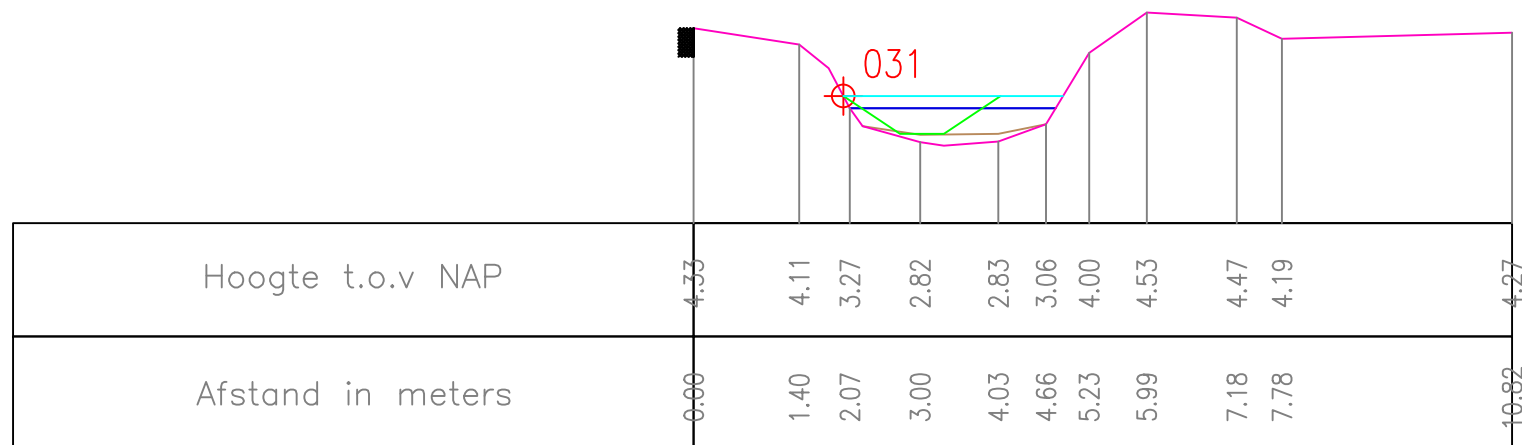



Oprachtgever		 HOOGHEEMRAADSCHAP DE STICHTSE RIJNLANDEN	Postbus 550 3990 GJ Houten	Poldermolen 2 3994 DD Houten									
Project			Tel.: (030) 634 57 00 Fax: (030) 634 59 98	e-mail: post@hdsr.nl www.destichtserijnlanden.nl									
Herprofilering Gooyerwetering Onderdeel ontwerp-profiel													
Projectnr.	401024	Besteknr(s).	Documentnr.	Status concept									
Formaat	A4	Schaal	1:100	Getek.	D.S.	Datum	9-7-2014	Goedgek.	Akk.	Tek.nr.	31	Versie	1

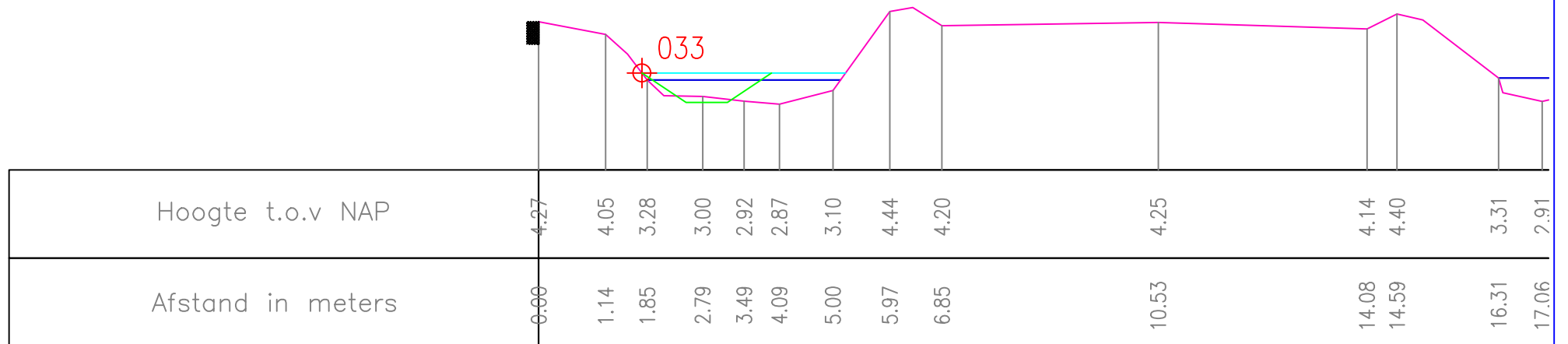

Hoogte t.o.v. NAP	4.35	4.10	3.28	3.09	3.01	2.96	4.53	4.25	4.36	4.30	4.57	4.13	3.29	2.90	2.87
Afstand in meters	0.00	1.39	1.94	2.61	3.31	3.87	5.44	6.86	10.67	13.60	14.19	15.11	16.00	16.52	17.04

Oprachtgever		 HOOGHEEMRAADSCHAP DE STICHTSE RIJNLANDEN		Postbus 550 3990 GJ Houten		Poldermolen 2 3994 DD Houten	
				Tel.: (030) 634 57 00		e-mail: post@hdsr.nl	
				Fax: (030) 634 59 98		www.destichtserijnlanden.nl	
Project							
Herprofilering Gooyerwetering							
Onderdeel							
ontwerp-profiel							
Projectnr.		Besteknr(s).		Documentnr.		Status	
401024						concept	
Formaat	Schaal	Getek.	Datum	Goedgek.	Akk.	Tek.nr.	Versie
A4	1:100	D.S.	9-7-2014			32	1



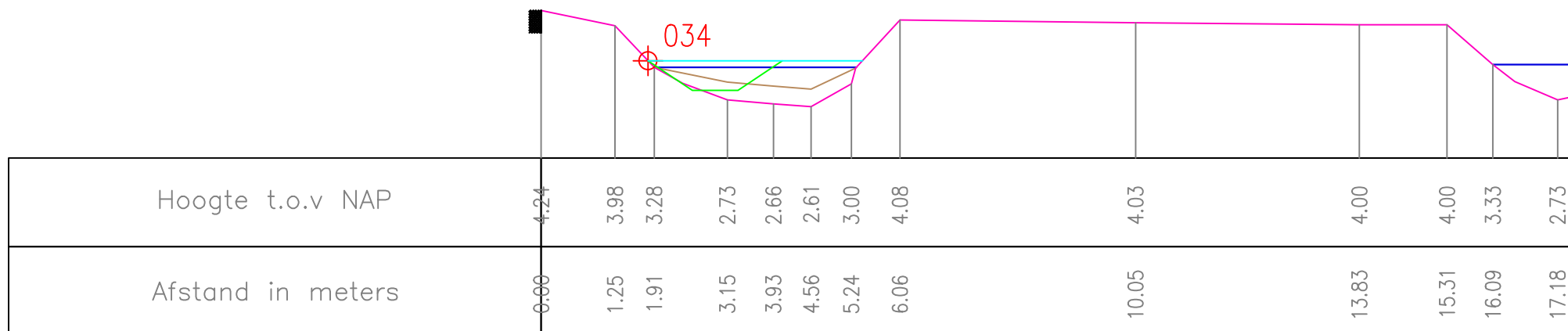

Oprachtgever		 HOOGHEEMRAADSCHAP DE STICHTSE RIJNLANDEN	Postbus 550 3990 GJ Houten	Poldermolen 2 3994 DD Houten									
Project			Tel.: (030) 634 57 00 Fax: (030) 634 59 98	e-mail: post@hdsr.nl www.destichtserijnlanden.nl									
Herprofilering Gooyerwetering Onderdeel ontwerp-profiel													
Projectnr.	401024	Besteknr(s).	Documentnr.	Status concept									
Formaat	A4	Schaal	1:100	Getek.	D.S.	Datum	9-7-2014	Goedgek.	Akk.	Tek.nr.	33	Versie	1

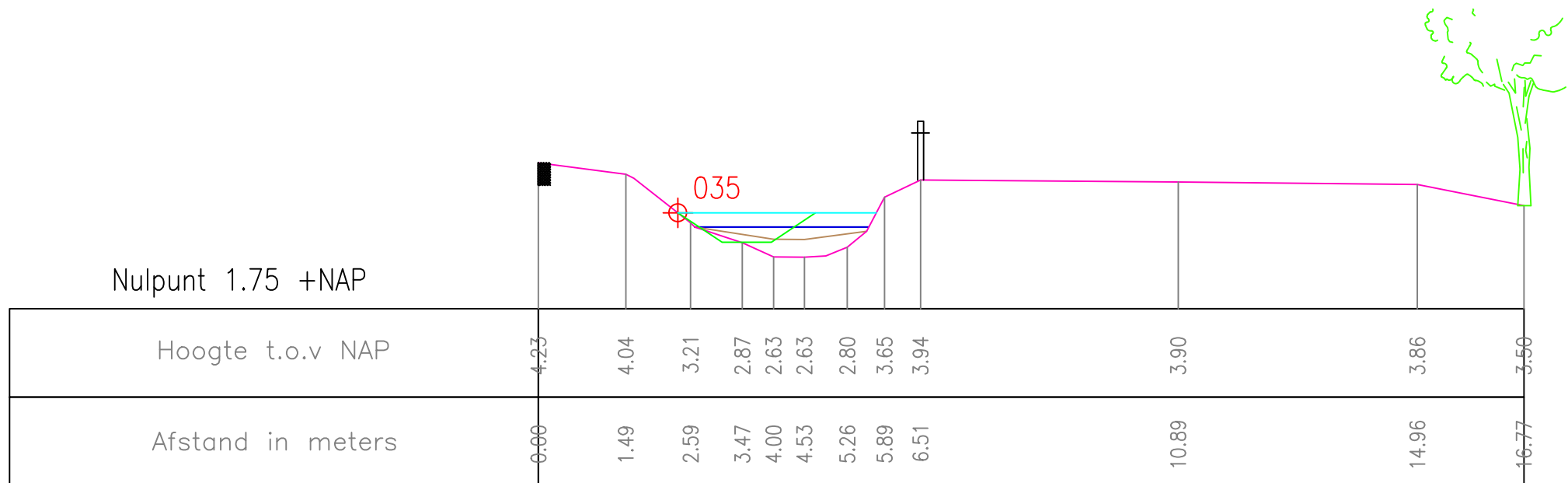

Oprachtgever		 HOOGHEEMRAADSCHAP DE STICHTSE RIJNLANDEN	Postbus 550 3990 GJ Houten		Poldermolen 2 3994 DD Houten	
			Tel.: (030) 634 57 00 Fax: (030) 634 59 98		e-mail: post@hdsr.nl www.destichtserijnlanden.nl	
Project						
Herprofilering Gooyerwetering						
Onderdeel						
ontwerp-profiel						
Projectnr.		Besteknr(s).		Documentnr.		Status
401024						concept
Formaat	Schaal	Getek.	Datum	Goedgek.	Akk.	Tek.nr.
A4	1:100	D.S.	9-7-2014			34
						Versie
						1

Nulpunt 1.75 +NAP



Oprachtgever		 HOOGHEEMRAADSCHAP DE STICHTSE RIJNLANDEN		Postbus 550 3990 GJ Houten Tel.: (030) 634 57 00 Fax: (030) 634 59 98		Poldermolen 2 3994 DD Houten e-mail: post@hdsr.nl www.destichtserijnlanden.nl	
Project							
Herprofilering Gooyerwetering							
Onderdeel							
ontwerp-profiel							
Projectnr.		Besteknr(s).		Documentnr.		Status	
401024						concept	
Formaat	Schaal	Getek.	Datum	Goedgek.	Akk.	Tek.nr.	Versie
A4	1:100	D.S.	9-7-2014			35	1

Nulpunt 1.75 +NAP

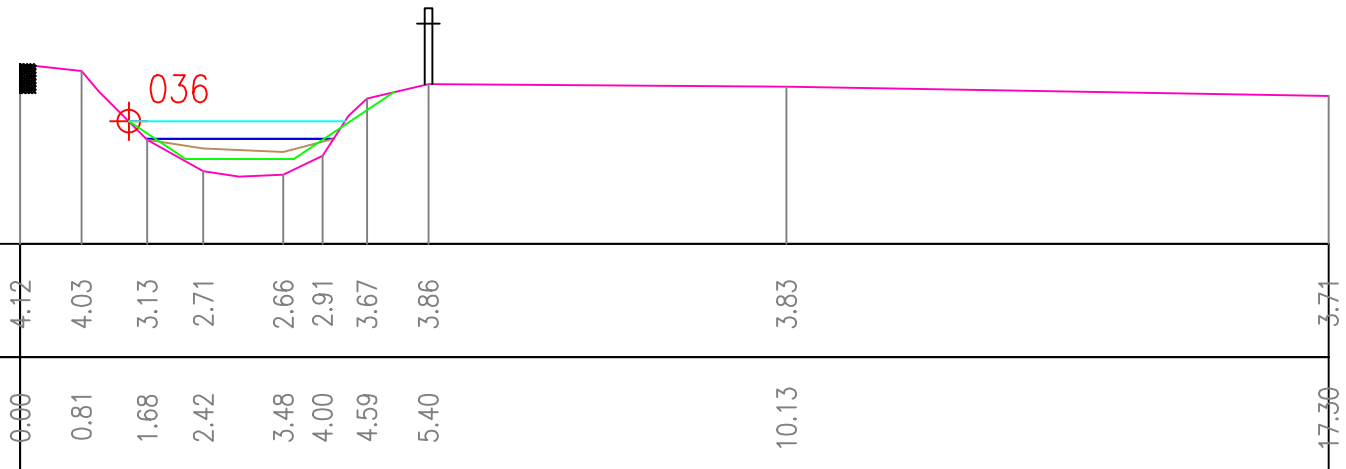

Opdrachtgever		 HOOGHEEMRAADSCHAP DE STICHTSE RIJNLANDEN		Postbus 550 3990 GJ Houten		Poldermolen 2 3994 DD Houten	
Project		Herprofilering Gooyerwetering					
Onderdeel		ontwerp-profiel					
Projectnr.	401024	Besteknr(s).		Documentnr.		Status	concept
Formaat	A4	Schaal	1:100	Getek.	D.S.	Datum	9-7-2014
Goedgek.		Akk.		Tek.nr.	36	Versie	1

Nulpunt 1.75 +NAP

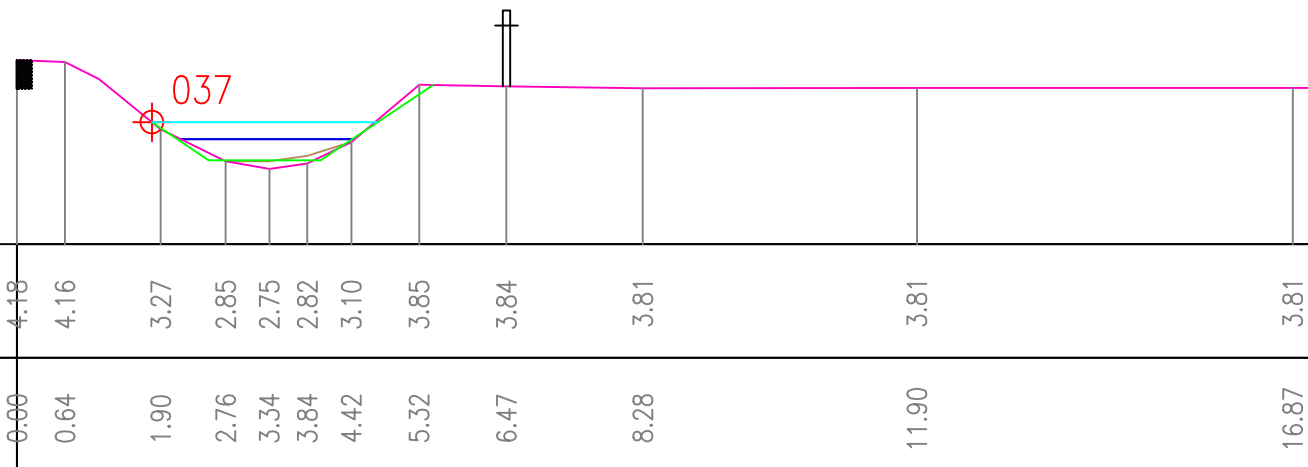

Oprachtgever		 HOOGHEEMRAADSCHAP DE STICHTSE RIJNLANDEN		Postbus 550 3990 GJ Houten		Poldermolen 2 3994 DD Houten	
Project		Herprofilering Gooyerwetering					
Onderdeel		ontwerp-profiel					
Projectnr.	401024	Besteknr(s).		Documentnr.		Status	concept
Formaat	A4	Schaal	1:100	Getek.	D.S.	Datum	9-7-2014
		Goedgek.		Akk.		Tek.nr.	37
						Versie	1

Nulpunt 1.75 +NAP

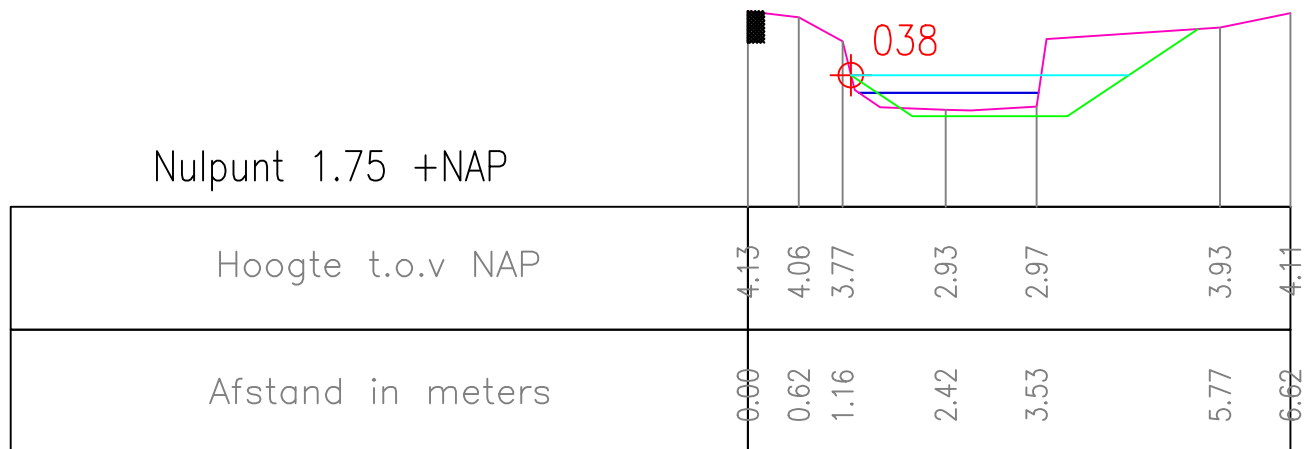

Oprachtgever		 HOOGHEEMRAADSCHAP DE STICHTSE RIJNLANDEN	Postbus 550 3990 GJ Houten	Poldermolen 2 3994 DD Houten									
Project			Tel.: (030) 634 57 00 Fax: (030) 634 59 98	e-mail: post@hdsr.nl www.destichtserijnlanden.nl									
Herprofilering Gooyerwetering Onderdeel ontwerp-profiel													
Projectnr.	401024	Besteknr(s).	Documentnr.	Status concept									
Formaat	A4	Schaal	1:100	Getek.	D.S.	Datum	9-7-2014	Goedgek.	Akk.	Tek.nr.	38	Versie	1

Nulpunt 1.75 +NAP

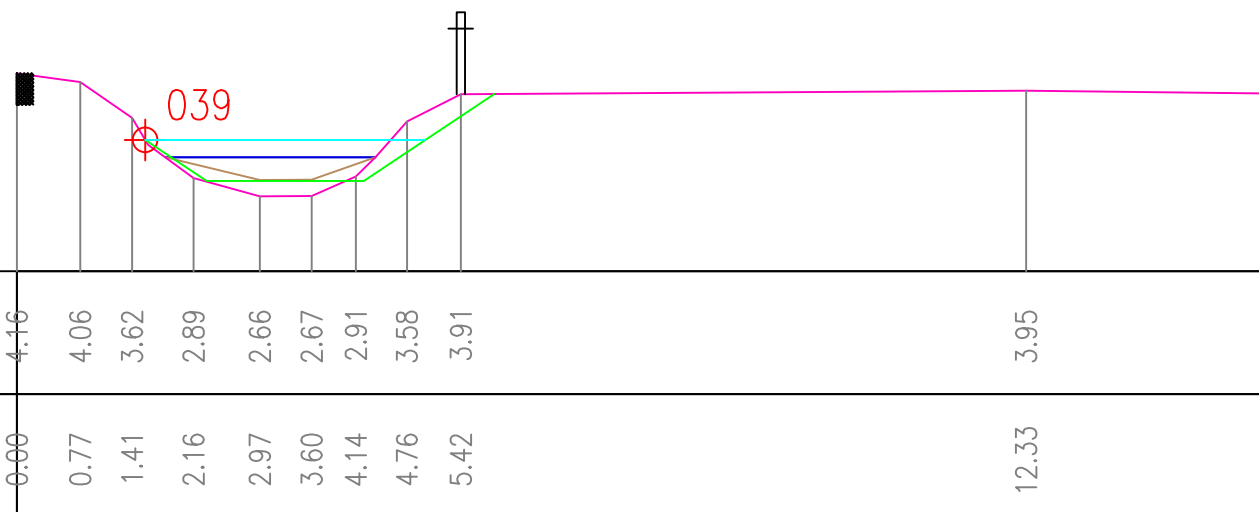

Oprachtgever		 HOOGHEEMRAADSCHAP DE STICHTSE RIJNLANDEN	Postbus 550 3990 GJ Houten		Poldermolen 2 3994 DD Houten	
			Tel.: (030) 634 57 00 Fax: (030) 634 59 98		e-mail: post@hdsr.nl www.destichtserijnlanden.nl	
Project						
Herprofilering Gooyerwetering						
Onderdeel						
ontwerp-profiel						
Projectnr.		Besteknr(s).		Documentnr.		Status
401024						concept
Formaat	Schaal	Getek.	Datum	Goedgek.	Akk.	Tek.nr.
A4	1:100	D.S.	9-7-2014			39
						Versie
						1

Nulpunt 1.75 +NAP

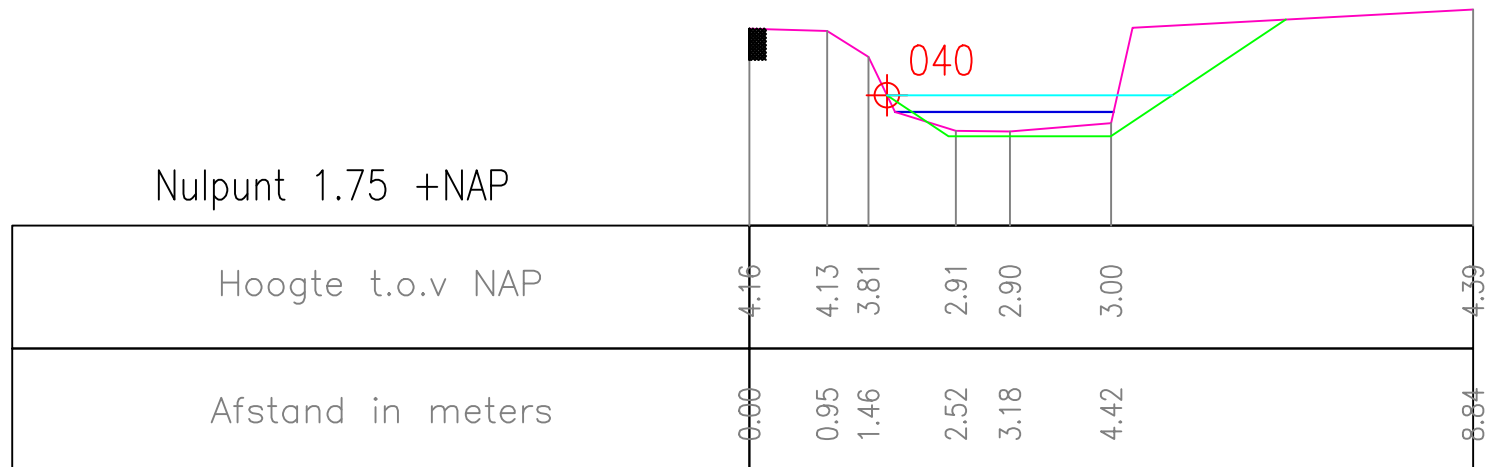

Oprichtgever		 HOOGHEEMRAADSCHAP DE STICHTSE RIJNLANDEN	Postbus 550 3990 GJ Houten	Poldermolen 2 3994 DD Houten									
Project			Tel.: (030) 634 57 00 Fax: (030) 634 59 98	e-mail: post@hdsr.nl www.destichtserijnlanden.nl									
Herprofilering Gooyerwetering Onderdeel ontwerp-profiel													
Projectnr.	401024	Besteknr(s).	Documentnr.	Status concept									
Formaat	A4	Schaal	1:100	Getek.	D.S.	Datum	9-7-2014	Goedgek.	Akk.	Tek.nr.	40	Versie	1

Nulpunt 1.75 +NAP

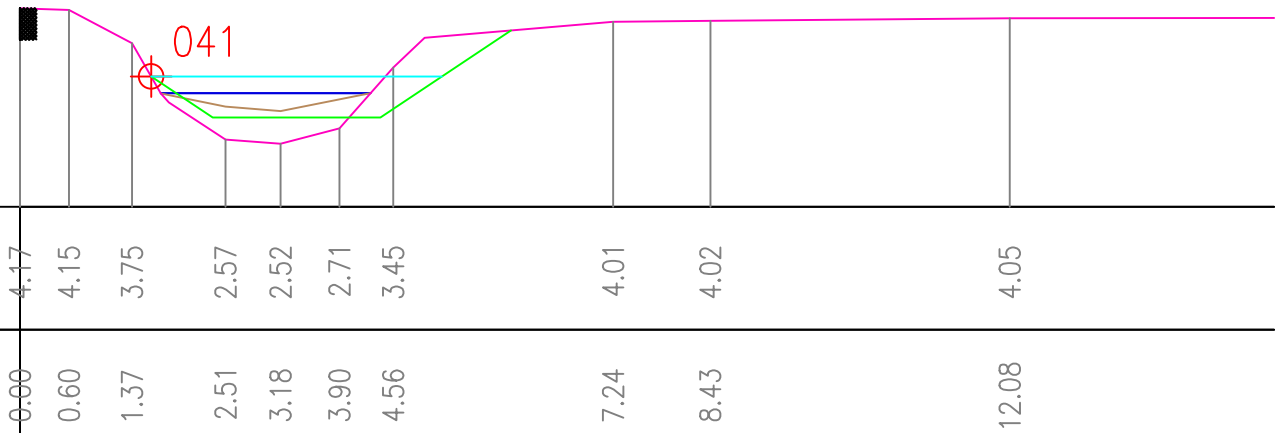

Oprachtgever		 HOOGHEEMRAADSCHAP DE STICHTSE RIJNLANDEN	Postbus 550 3990 GJ Houten	Poldermolen 2 3994 DD Houten									
Project			Tel.: (030) 634 57 00 Fax: (030) 634 59 98	e-mail: post@hdsr.nl www.destichtserijnlanden.nl									
Herprofilering Gooyerwetering Onderdeel ontwerp-profiel													
Projectnr.	401024	Besteknr(s).	Documentnr.	Status concept									
Formaat	A4	Schaal	1:100	Getek.	D.S.	Datum	9-7-2014	Goedgek.	Akk.	Tek.nr.	41	Versie	1

Nulpunt 1.75 +NAP

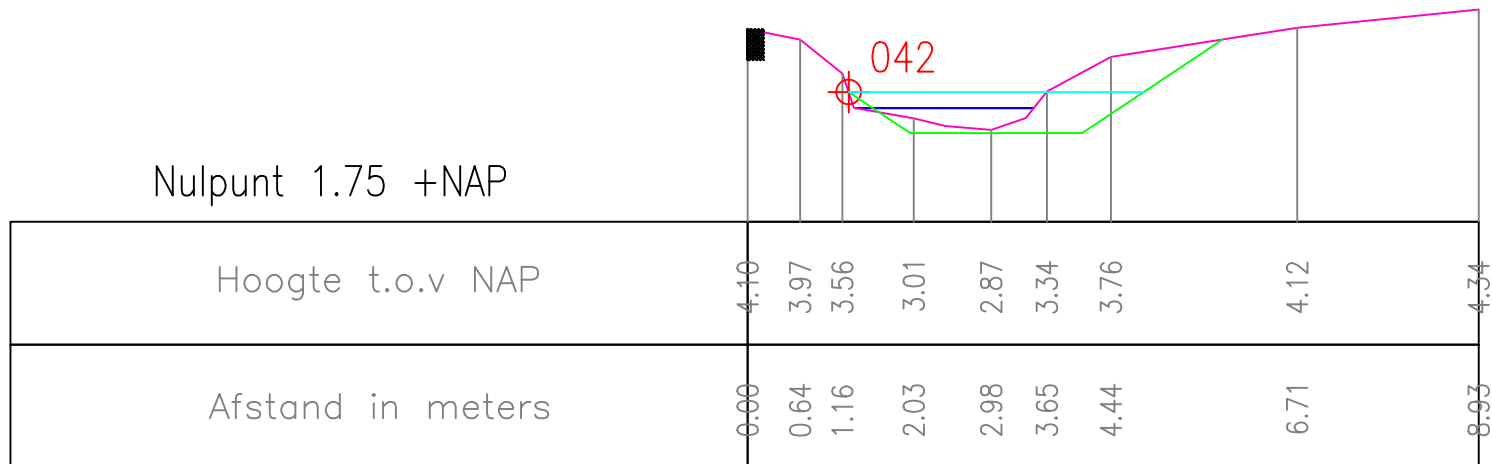

Oprachtgever		 HOOGHEEMRAADSCHAP DE STICHTSE RIJNLANDEN	Postbus 550 3990 GJ Houten	Poldermolen 2 3994 DD Houten									
Project			Tel.: (030) 634 57 00 Fax: (030) 634 59 98	e-mail: post@hdsr.nl www.destichtserijnlanden.nl									
<p>Onderdeel</p> <h2>Herprofilering Gooyerwetering</h2> <h3>ontwerp-profiel</h3>													
Projectnr.	401024	Besteknr(s).	Documentnr.	Status concept									
Formaat	A4	Schaal	1:100	Getek.	D.S.	Datum	9-7-2014	Goedgek.	Akk.	Tek.nr.	42	Versie	1

Nulpunt 1.75 +NAP

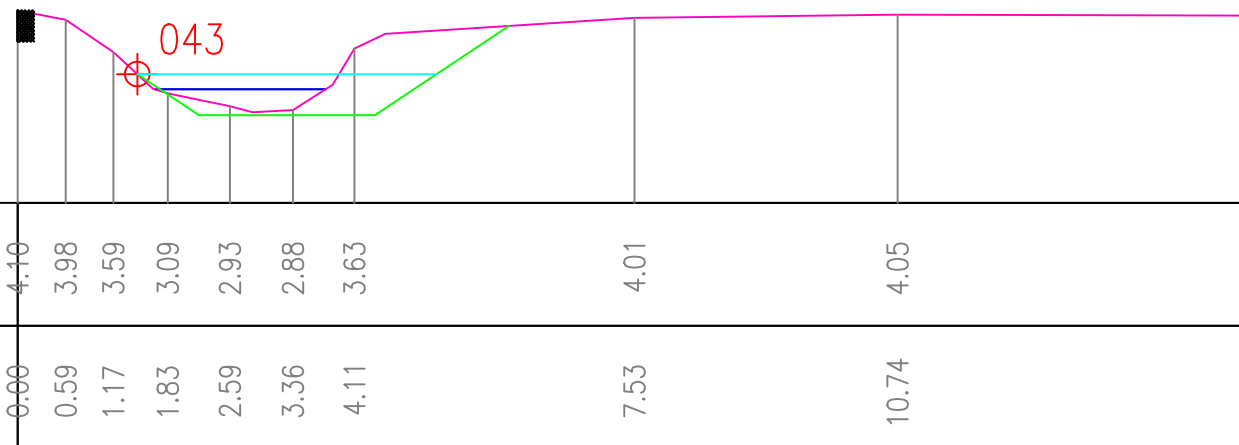

Oprachtgever		 HOOGHEEMRAADSCHAP DE STICHTSE RIJNLANDEN	Postbus 550 3990 GJ Houten	Poldermolen 2 3994 DD Houten									
Project			Tel.: (030) 634 57 00 Fax: (030) 634 59 98	e-mail: post@hdsr.nl www.destichtserijnlanden.nl									
Herprofilering Gooyerwetering Onderdeel ontwerp-profiel													
Projectnr.	401024	Besteknr(s).	Documentnr.	Status concept									
Formaat	A4	Schaal	1:100	Getek.	D.S.	Datum	9-7-2014	Goedgek.	Akk.	Tek.nr.	43	Versie	1

Nulpunt 1.75 +NAP

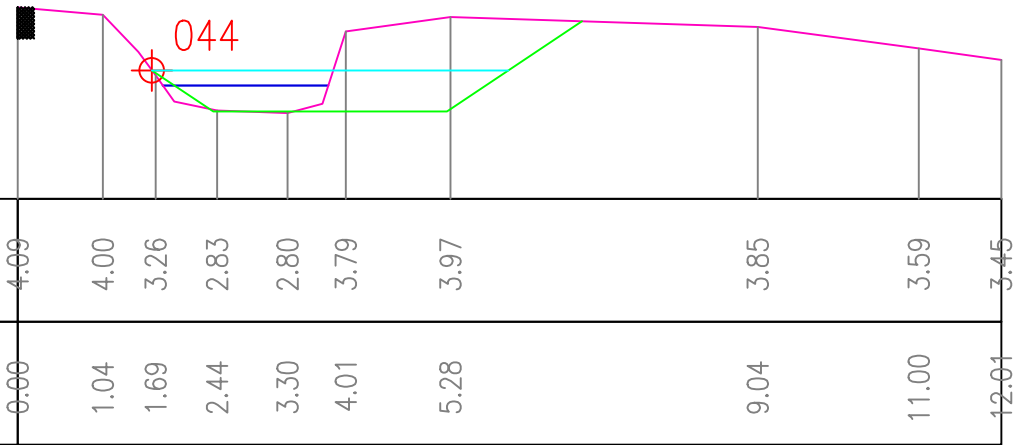

Oprachtgever		 HOOGHEEMRAADSCHAP DE STICHTSE RIJNLANDEN	Postbus 550 3990 GJ Houten	Poldermolen 2 3994 DD Houten									
Project			Tel.: (030) 634 57 00 Fax: (030) 634 59 98	e-mail: post@hdsr.nl www.destichtserijnlanden.nl									
Herprofilering Gooyerwetering ontwerp-profiel													
Projectnr.	401024	Besteknr(s).	Documentnr.	Status concept									
Formaat	A4	Schaal	1:100	Getek.	D.S.	Datum	9-7-2014	Goedgek.	Akk.	Tek.nr.	44	Versie	1

Nulpunt 1.75 +NAP

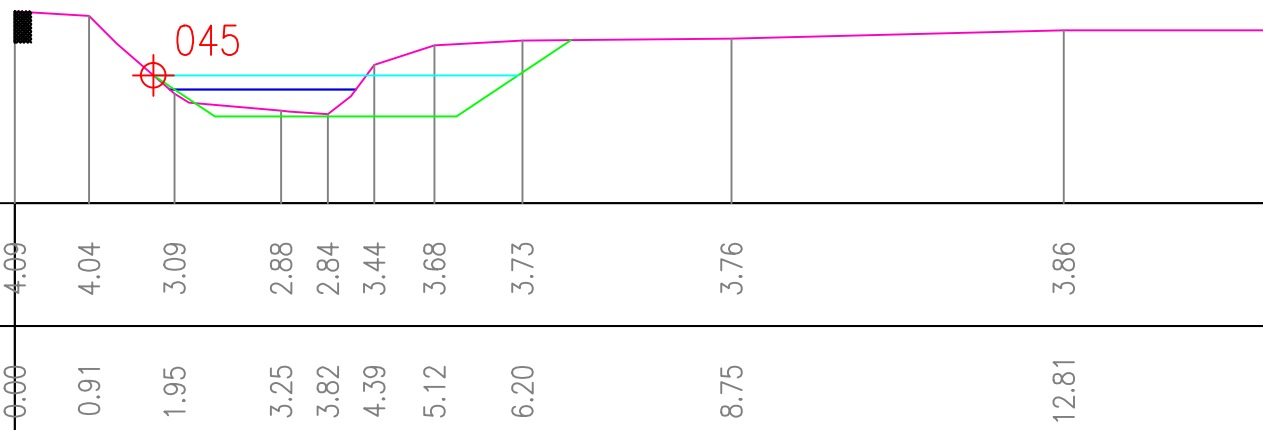

Hoogte t.o.v NAP	4.09	4.04	3.09	2.88	2.84	3.44	3.68	3.73	3.76	3.86
Afstand in meters	0.00	0.91	1.95	3.25	3.82	4.39	5.12	6.20	8.75	12.81

Oprachtgever		 HOOGHEEMRAADSCHAP DE STICHTSE RIJNLANDEN	Postbus 550 3990 GJ Houten	Poldermolen 2 3994 DD Houten
Project			Tel.: (030) 634 57 00 Fax: (030) 634 59 98	e-mail: post@hdsr.nl www.destichtserijnlanden.nl
Herprofilering Gooyerwetering Onderdeel ontwerp-profiel				
Projectnr.	401024	Besteknr(s).	Documentnr.	Status concept
Formaat A4	Schaal 1:100	Getek. D.S.	Datum 9-7-2014	Goedgek. Akk. Tek.nr. 45 Versie 1

Nulpunt 1.75 +NAP

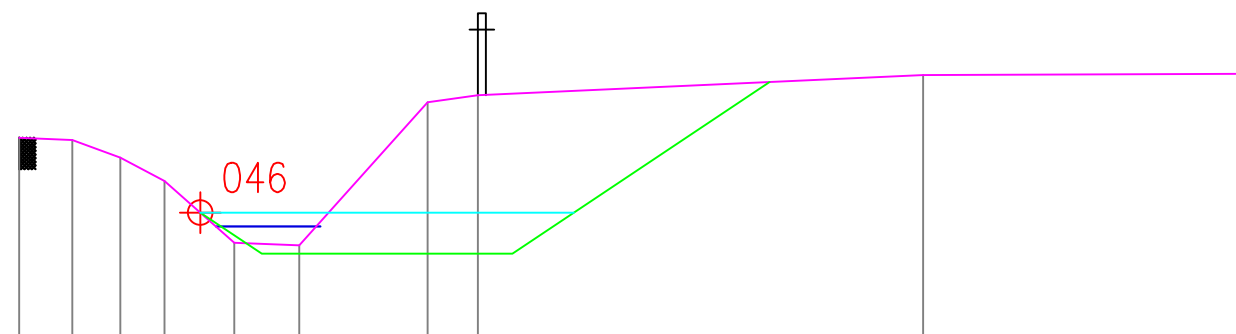

Hoogte t.o.v NAP	4.21	4.19	3.97	3.69	2.93	2.90	4.65	4.73	4.98
Afstand in meters	0.00	0.65	1.24	1.78	2.63	3.42	4.99	5.60	11.04

Oprachtgever		 HOOGHEEMRAADSCHAP DE STICHTSE RIJNLANDEN	Postbus 550 3990 GJ Houten	Poldermolen 2 3994 DD Houten									
Project			Tel.: (030) 634 57 00 Fax: (030) 634 59 98	e-mail: post@hdsr.nl www.destichtserijnlanden.nl									
Onderdeel													
Herprofilering Gooyerwetering													
ontwerp-profiel													
Projectnr.	401024	Besteknr(s).	Documentnr.	Status concept									
Formaat	A4	Schaal	1:100	Getek.	D.S.	Datum	9-7-2014	Goedgek.	Akk.	Tek.nr.	46	Versie	1

Nulpunt 1.75 +NAP

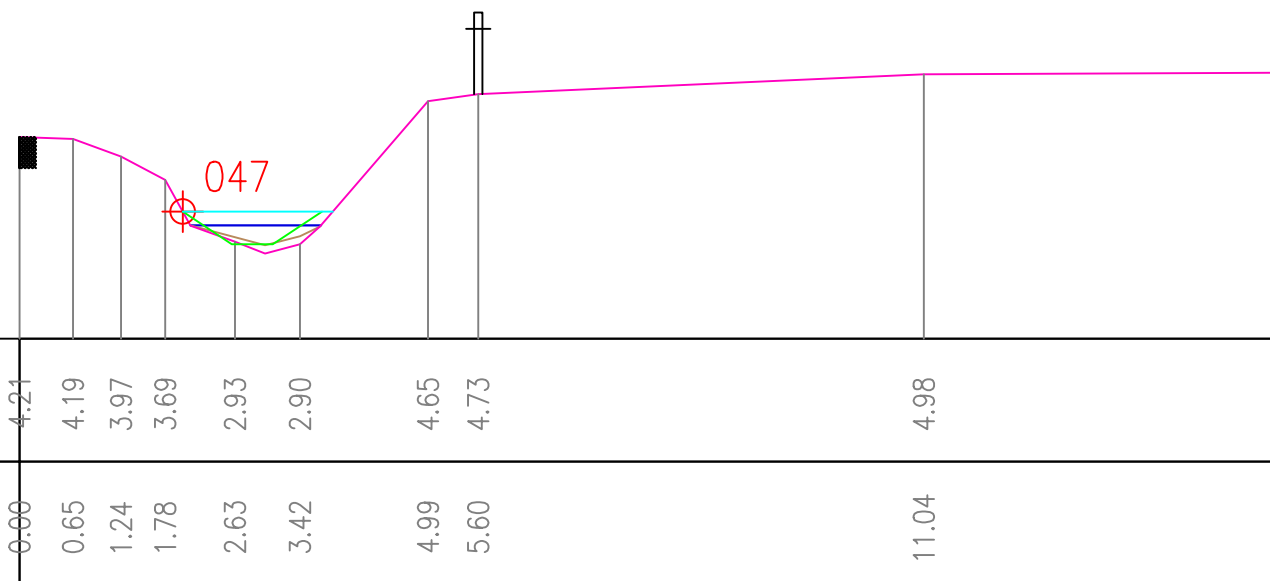

Opdrachtgever		 HOOGHEEMRAADSCHAP DE STICHTSE RIJNLANDEN		Postbus 550 3990 GJ Houten		Poldermolen 2 3994 DD Houten	
Project		Herprofilering Gooyerwetering					
Onderdeel		ontwerp-profiel					
Projectnr.	401024	Besteknr(s).		Documentnr.		Status	concept
Formaat	A4	Schaal	1:100	Getek.	D.S.	Datum	9-7-2014
		Goedgek.		Akk.		Tek.nr.	47
						Versie	1

Nulpunt 2.75 +NAP

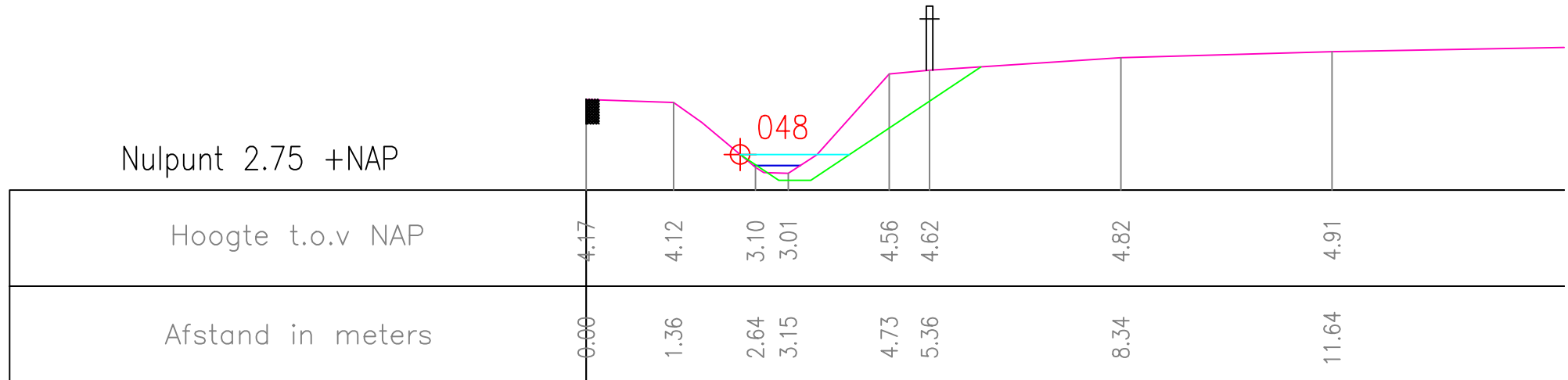

Oprachtgever		 HOOGHEEMRAADSCHAP DE STICHTSE RIJNLANDEN	Postbus 550 3990 GJ Houten	Poldermolen 2 3994 DD Houten									
Project			Tel.: (030) 634 57 00 Fax: (030) 634 59 98	e-mail: post@hdsr.nl www.destichtserijnlanden.nl									
Herprofilering Gooyerwetering Onderdeel ontwerp-profiel													
Projectnr.	401024	Besteknr(s).	Documentnr.	Status concept									
Formaat	A4	Schaal	1:100	Getek.	D.S.	Datum	9-7-2014	Goedgek.	Akk.	Tek.nr.	48	Versie	1

Nulpunt 2.75 +NAP

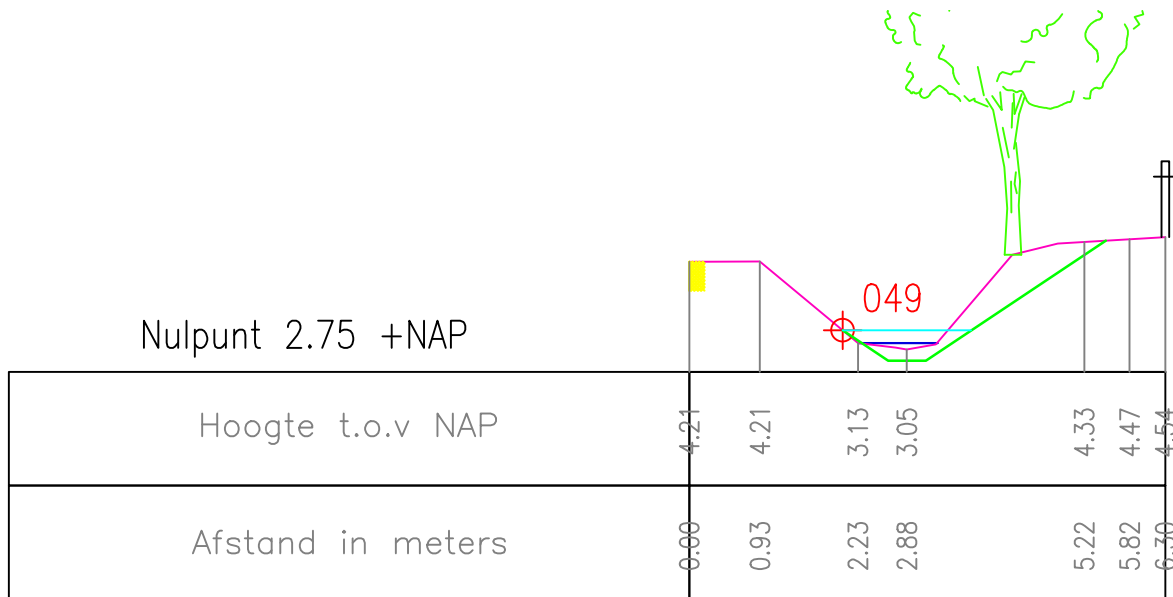

Oprachtgever



HOOGHEEMRAADSCHAP
DE STICHTSE
RIJNLANDEN

Postbus 550
3990 GJ Houten

Poldermolen 2
3994 DD Houten

Tel.: (030) 634 57 00
Fax: (030) 634 59 98

e-mail: post@hdsr.nl
www.destichtserijnlanden.nl

Project

Herprofilering Gooyerwetering

Onderdeel

ontwerp-profiel

Projectnr.

401024

Besteknr(s).

Documentnr.

Status

concept

Formaat

A4

Schaal

1:100

Getek.

D.S.

Datum

9-7-2014

Goedgek.

Akk.

Tek.nr.

49

Versie

1

