



STATISCHE BEREKENING

T.B.V.

WERK : Vergadercentrum de Krim De Cocksdorp

OPDRACHTGEVER : Bouw2020

ORDERNR : 10745

CONSTRUCTEUR : ing. H.J.J.H. Huls

DATUM : 15 januari 2025

GEWIJZIGD :

Gemeente Texel **.txl**

Behoort bij besluit van
Burgemeester en Wethouders van Texel,
zaaknummer: 3690355
kenmerk document: bijlage 14/17
namens de burgemeester en wethouders van Texel,

de heer R. Westbroek
afdelingsmanager Beleid & Vergunningen

- Inhoudsopgave -

1	Algemene gegevens	4
1.1	Voorschriften	4
1.2	Rekensoftware	4
1.3	Bouwwerkgegevens:	4
1.4	Belastingen	5
1.5	Noodoverlaten	7
2	Houtconstructie	8
2.1	Doorsnede schakeldak	8
2.2	Ligger schakeldak	29
2.3	Hoekkeper	44
2.4	Spoor in overstek	54
3	Staalconstructie	62
3.1	Dakniveau	62
3.1.1	Randligger as 1 en A	62
3.1.2	Drukkoker schakeldak	66
3.1.3	Dakligger as B en C	73
3.1.4	Dakligger as 4	74
3.2	Kolom as E	75
3.3	Niveau verdieping	81
3.3.1	Randligger as 1 / A-B	81
3.3.2	Randligger as 1 / B-C	81
3.3.3	Randligger as 1 / C-E	85
3.3.4	Tussenliggers as 2 en 3 / A-B	86
3.3.5	Ligger as 2 / B-C	87
3.3.6	Ligger as 3 / B-C	87
3.3.7	Ligger as 3 vergaderruimte - berging	88
3.3.8	Ligger as 4 tpv hal-gang	89
3.3.9	Ligger as 4 tpv berging-gang	90
3.3.10	Ligger as 4 tpv berging-gang	91
3.3.11	Ligger as B / 4-5	91
3.3.12	Ligger as 5	92
3.4	Gevelkolommen	95
3.5	Tussenkolom	111
3.6	Kolommen dakoverstek stramien A/1	119
3.7	Ligger dakoverstek	126
3.8	Kolom as 5	130

4	Metselwerk.....	136
4.1	Wand as E.....	136
4.2	Wand as 5.....	136
4.3	Wand D200 mm.....	137
5	Betonconstructie	138
5.1	Belastingopstelling fundering.....	138
5.2	Berekening stroken.....	144
5.2.1	Doorsnede as D.....	144
5.2.2	Doorsnede tussen B-C.....	165
5.2.3	Doorsnede as 2.....	181
5.2.4	Doorsnede tussen as 3-4.....	197
5.3	Berekening poeren.....	213
5.3.1	Poer as D1.....	213
5.3.2	Poer as B2 en B3.....	215
5.3.3	Poer as E1.....	215
5.3.4	Overige poeren.....	216
5.3.5	Poer tpv dakoverstek.....	217
5.4	Berekening wapening balken.....	223

Bijlage(n) :

1 ALGEMENE GEGEVENS

1.1 Voorschriften

Van toepassing zijn de voorschriften:

Eurocode 0 - Grondslagen

Eurocode 1 - Belastingen op constructies

Eurocode 2 - Ontwerp en berekening van betonconstructies

Eurocode 3 - Ontwerp en berekening van staalconstructies

Eurocode 4 - Ontwerp en berekening van staal-betonconstructies

Eurocode 5 - Ontwerp en berekening van houtconstructies

Eurocode 6 - Ontwerp en berekening van metselwerk

Eurocode 7 - Geotechnisch ontwerp

1.2 Rekensoftware

		versie
Technosoft	Raamwerken	6.83
	Liggers	6.81
	Verbindingen	6.75
	Construct	6.75
	Balkroosters	6.81
	Paalfunderingen	6.74
VNK	Staticaprogramma	6.00

1.3 Bouwwerkgegevens:

Type	:	Categorie C - Bijeenkomstruimtes	
Referentieperiode	:	50 jaar	
Gevolgklasse	:	CC 2	
Betrouwbaarheidsklasse	:	RC 2	($K_{FI} = 1.0$)

1.4 Belastingen

			g_k [kN/m ²]	q_k [kN/m ²]	Q_k [kN]	Ψ_0	Ψ_1	Ψ_2
Dak (schuin)								
dakhelling $\alpha = 30^\circ$	$\cos(\alpha) = 0.866$							
zinkendak incl afwerking			0.75					
		totaal	0.75					
geprojecteerd t.b.v. fundering	$0.75 / 0.866$		0.87					
geprojecteerd t.b.v. houtwerk	$0.75 * 0.866$		0.65					
sneeuwlast met daken meer dan één overspanning, art. 5.3.4								
	$\alpha_1 = 30 \text{ gr.}$	$\alpha_2 = 30 \text{ gr.}$						
sneeuwbelasting α_1	$(\mu_1 * s_k)$	$0.80 * 0.7$		0.56				
sneeuwbelasting α_2	$(\mu_1 * s_k)$	$0.80 * 0.7$		0.56				
sneeuwbelasting α_{gem}	$(\mu_2 * s_k)$	$1.60 * 0.7$		1.12				
Dak (plat hout)								
dakbedekking + beschot + isolatie			0.40					
plafond			0.25					
installaties			0.25					
		totaal	0.90					
Dak (plat beton)								
dakbedekking			0.10					
afschot isolatie			0.15					
druklaag_50mm			1.25					
kanaalplaatvloer D200mm			3.00					
plafond			0.25					
installaties			0.25					
		totaal	5.00					
sneeuw dak plat	$0.8 * 0.7$			0.56		0.0	0.2	0.0
veranderlijke belasting (q_k max. 10m ²)	1.00			1.00	1.5			
Verdiepingsvloer D320mm								
afwerking	$20 * 0.07$		1.40					
druklaag_50mm	$25 * 0.05$		1.25					
kanaalplaatvloer D320mm			4.30					
installatie			0.25					
plafond			0.25					
		totaal	7.45			*		
opgelegde belasting	5.00			5.00	7	0.4	0.7	0.6
Verdiepingsvloer D200mm								
afwerking	$20 * 0.07$		1.40					
druklaag_50mm	$25 * 0.05$		1.25					
kanaalplaatvloer D200mm			3.00					
installatie			0.25					
plafond			0.25					
		totaal	6.15			*		
opgelegde belasting	5.00			5.00	7	0.4	0.7	0.6
Begane grondvloer								
afwerking	$20 * 0.08$		1.60					
beton D200mm	$25 * 0.20$		5.00					
		totaal	6.60			*		
opgelegde belasting	5.00			5.00	7	0.4	0.7	0.6
Gevel								
			1.00					
Metselwerk_D120mm								
			2.40					
Metselwerk_D150mm								
			3.00					
Metselwerk_D214mm								
			4.00					
Schuifwand								
			0.70					
Windbelasting								

ref.periode		50	
w indgebied		1	
terreinruw heid		Onbebouwd	
gebouw vorm		rechthoekig gebouw , platdak	
gebouw hoogte		8 m	
maaiveld tot peil		0 m	
terpen/kliffen aanwezig?		N	c_0 : 1.00
hoge naburige gebouwen?		N	
$V_{b,0}$:	29.50 m/s	
C_{dir}	:	1	
C_{season}	:	1	
V_b	:	29.50 m/s	formule (4.1)
C_{prob}	:	1.000	
$V_{b(p)}$:	29.50 m/s	
Z_0	:	0.200 m	
Z_{min}	:	4.000 m	
k_r	:	0.21	formule (4.5)
Z	:	8 m	
C_r	:	0.77	formule (4.4)
$V_m(Z)$:	22.78 m/s	formule (4.3)

art. 4.5 extreme stuw druk

$l_v(z)$:	0.27 m
$q_p(z)$:	0.940 kN/m ²

stuwdruk	$q_p(z)$:	0.940	0.94	ψ_0	0	ψ_1	0.2	ψ_2	0
----------	------------	-------	------	----------	---	----------	-----	----------	---

1.5 Noodoverlaten

Bestaand dak vloeit 80 m² water af op nieuw dak. Rechts naast de uitbreiding geeft geen waterafdracht. Regulier Pluvia toepassen + een nood Pluvia systeem. Berekening volgens leverancier.

Totaal dakoppervlak 246 + 239 = 485 m²

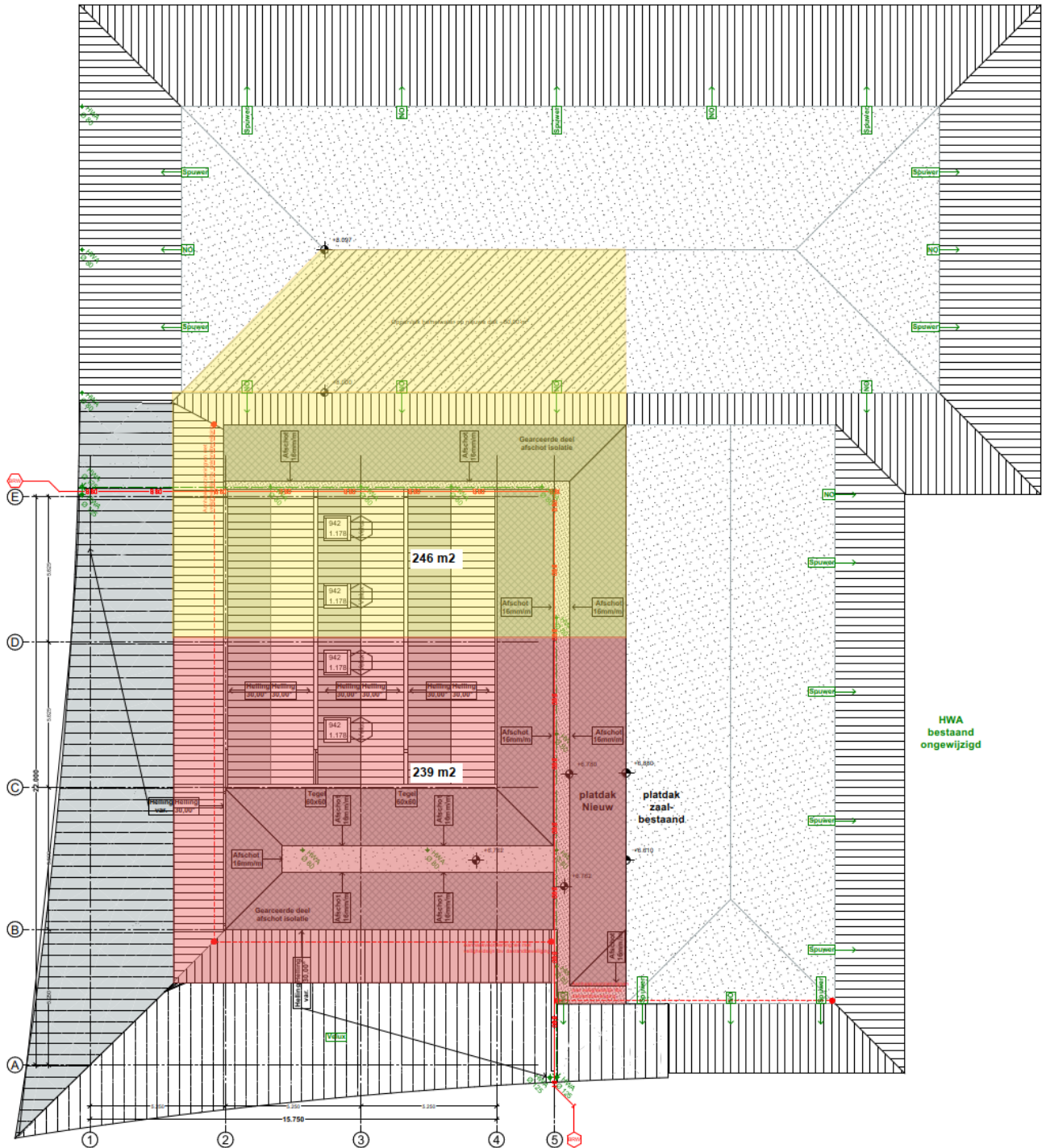

2 HOUTCONSTRUCTIE

2.1 Doorsnede schakeldak

blijvend

dak_schuin 0.75 = 0.75 kN/m¹

Technosoft Raamwerken release 6.84b

14 nov 2025

Project.....: 10745
Onderdeel....: dsn schakeldak lage rand
Dimensies....: kN;m;rad (tenzij anders aangegeven)
Bestand.....: N:\Order\10000\10700\10745\berekeningen en schetsen\dsn
 schakeldak lage rand.rww

Belastingbreedte.: 1.000
Rekenmodel.....: 2e-orde-elastisch.
Theorieën voor de bepaling van de krachtsverdeling:
1) Losse belastinggevallen:
 Lineaire-elasticiteitstheorie
2) Uiterste grenstoestand:
 Geometrisch niet lineair alle staven.
 Fysisch lineair alle staven.
3) Gebruiksgrenstoestand:
 Lineaire-elasticiteitstheorie

Maximum aantal iteraties.....: 50
Max.deellengte kolommen/wanden: 0.500 Max.deellengte balken/vloeren: 0.500
Max. X-verplaatsing in UGT.....: 0.500 Max. Z-verplaatsing in UGT...: 0.250

Gunstige werking van de permanente belasting wordt automatisch verwerkt.

Toegepaste normen volgens Eurocode met Nederlandse NB

Belastingen	NEN-EN 1990:2002	C2:2010,A1:2019	NB:2019(nl)
	NEN-EN 1991-1-1:2002	C1/C11:2019	NB:2019(nl)
	NEN-EN 1991-1-3:2003	A1:2019	NB:2019(nl)
	NEN-EN 1991-1-4:2005	C2:2023	NB:2019(nl)
Hout	NEN-EN 1995-1-1:2005	A2:2014,C1:2012	NB:2013(nl)

Project.....: 10745
 Onderdeel....: dsn schakeldak lage rand

GEOMETRIE

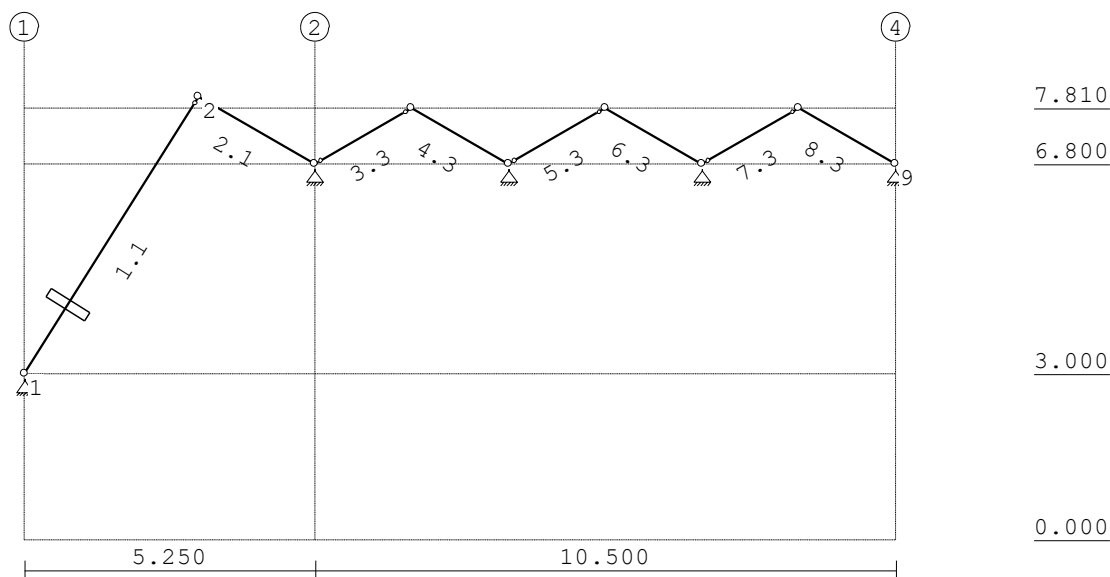

STRAMIENLIJNEN

Nr.	Naam	X	Z-min	Z-max
1	1	0.000	0.000	8.012
2	2	5.250	0.000	8.012
3	4	15.750	0.000	8.012

NIVEAUS

Nr.	Z	X-min	X-max
1	0.000	0.000	15.750
2	3.000	0.000	15.750
3	6.800	0.000	15.750
4	7.810	0.000	15.750

MATERIALEN

Mt	Kwaliteit	E-modulus [N/mm ²]	S.G.	S.G.verhoogd	Pois.	Uitz. coëff
1	C24	11000	3.5	4.2	1.00	5.0000e-06
2	S235	210000	78.5		0.30	1.2000e-05

Bij de bepaling v.h. e.g. van houten staven is de S.G.verhoogd toegepast.

PROFIELEN [mm]

Prof.	Omschrijving	Materiaal	Oppervlak	Traagheid	Vormf.
1	B*H 63*286	1:C24	1.8018e+04	1.2282e+08	0.00
2	B60.3/4	2:S235	7.0749e+02	2.8173e+05	0.00
3	B*H 63*140	1:C24	8.8200e+03	1.4406e+07	0.00

Project.....: 10745
 Onderdeel....: dsn schakeldak lage rand

PROFIELEN vervolg [mm]

Prof.	Staaftype	Breedte	Hoogte	e	Type	b1	h1	b2	h2
1	0:Normaal	63	286	143.0	0:RH				
2	0:Normaal	60	60	30.2					
3	0:Normaal	63	140	70.0	0:RH				

PROFIELVORMEN [mm]

1 B*H 63*286



2 B60.3/4



3 B*H 63*140



KNOPEN

Knoop	X	Z	Knoop	X	Z
1	0.000	3.000	6	10.500	7.810
2	3.150	8.012	7	12.250	6.800
3	5.250	6.800	8	14.000	7.810
4	7.000	7.810	9	15.750	6.800
5	8.750	6.800			

STAVEN

St.	ki	kj	Profiel	Aansl.i	Aansl.j	Lengte	Opm.
1	1	2	1:B*H 63*286	NDM	ND-	5.920	
2	2	3	1:B*H 63*286	NDM	NDM	2.425	
3	3	4	3:B*H 63*140	ND-	ND-	2.021	
4	4	5	3:B*H 63*140	NDM	NDM	2.021	
5	5	6	3:B*H 63*140	ND-	ND-	2.021	
6	6	7	3:B*H 63*140	NDM	NDM	2.021	
7	7	8	3:B*H 63*140	ND-	ND-	2.021	
8	8	9	3:B*H 63*140	NDM	NDM	2.021	

VASTE STEUNPUNTEN

Nr.	knoop	Kode	XZR	l=vast	0=vrij	Hoek
1	1	110				0.00
2	3	110				0.00
3	5	110				0.00
4	7	110				0.00
5	9	110				0.00

BELASTINGENERATIE ALGEMEEN.

Betrouwbaarheidsklasse.....:	2	Referentieperiode.....:	50
Gebouwdiepte.....:	22.00	Gebouwhoogte.....:	8.01
Niveau aansl.terrein.....:	0.00	E.g. scheid.w. [kN/m2]:	0.00

Project.....: 10745
 Onderdeel....: dsn schakeldak lage rand

WIND

Terrein categorie ...[4.3.2]...: Onbebouwd
 Windgebied: 1 Vb,0 ..[4.2].....: 29.500
 Positie spant in het gebouw....: 5.000 Kr[4.3.2].....: 0.209
 z0[4.3.2]...: 0.200 Zmin ..[4.3.2].....: 4.000
 Co wind van links ..[4.3.3]...: 1.000 Co wind van rechts....: 1.000
 Co wind loodrecht ..[4.3.3]...: 1.000
 Cpi wind van links ..[7.2.9]...: 0.200 -0.300
 Cpi windloodrecht ...[7.2.9]...: 0.200 -0.300
 Cpi wind van rechts .[7.2.9]...: 0.200 -0.300
 Cfr windwrijving[7.5].....: 0.040

SNEEUW

Sneeuwbelasting (sk) 50 jaar : 0.70
 Sneeuwbelasting (sn) n jaar : 0.70

STAAFTYPEN

Type staven
 7:Dak. : 1-8

LASTVELDEN

Wind staven

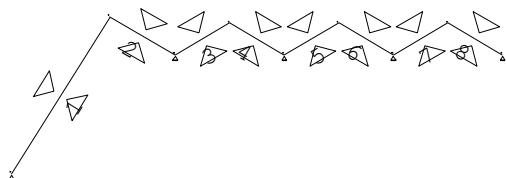

Sneeuw staven

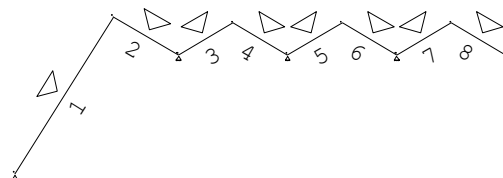

WIND DAKTYPES

Nr.	Staaftype	reductie bij wind van links	reductie bij wind van rechts	Cpe volgens art:
1	1 Lessenaarsdak	1.000	0.600	7.2.4
2	2 Zadeldak	1.000	0.600	7.2.5
3	3 Zadeldak	1.000	0.600	7.2.5
4	4 Zadeldak	0.600	0.600	7.2.5
5	5 Zadeldak	0.600	0.600	7.2.5
6	6 Zadeldak	0.600	1.000	7.2.5
7	7 Zadeldak	0.600	1.000	7.2.5
8	8 Lessenaarsdak	0.600	1.000	7.2.4

Let op: het in rekening brengen van het gebrek aan correlatie is bedoeld voor stabiliteitsberekeningen en niet voor de toetsing van individuele constructieonderdelen. Het gebrek aan correlatie wordt nu ten onrechte toegepast in een sterkteberekening.

Ten behoeve van daken met aaneengeschoolde vormen zijn de reductiefactoren volgens EN1991-1-4 art. 7.2.7 in rekening gebracht.

Project.....: 10745
 Onderdeel....: dsn schakeldak lage rand

WIND ZONES

Wind van links

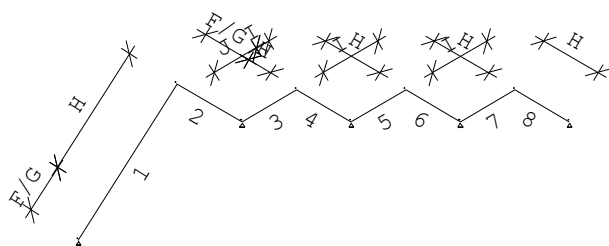

Wind van rechts

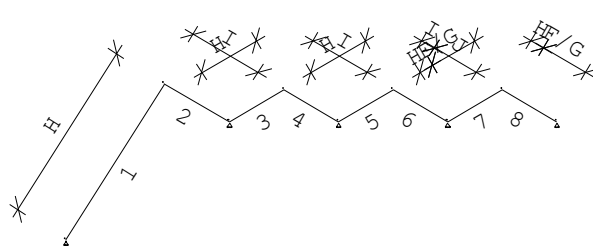

WIND VAN LINKS ZONES

Nr.	StAAF	Positie	Lengte	Zone
1	1	0.000	1.602	F/G
2	1	1.602	4.318	H
3	2	0.000	1.602	F/G
4	2	1.602	0.822	H
5	3	0.000	1.562	J
6	3	1.562	0.459	I
7	4	0.000	2.021	H
8	5	0.000	2.021	I
9	6	0.000	2.021	H
10	7	0.000	2.021	I
11	8	0.000	2.021	H

WIND VAN RECHTS ZONES

Nr.	StAAF	Positie	Lengte	Zone
1	8	0.000	1.562	F/G
2	8	1.562	0.459	H
3	7	0.000	1.562	F/G
4	7	1.562	0.459	H
5	6	0.000	1.562	J
6	6	1.562	0.459	I
7	5	0.000	2.021	H
8	4	0.000	2.021	I
9	3	0.000	2.021	H
10	2	0.000	2.425	I
11	1	0.000	5.920	H

Wind indexen

Index	CsCd	Cpe/Cpi	qp	breedte	reductie	Qw	Zone	Hoek(en)
Qw1		0.300	0.937	1.000		-0.281	-i	
Qw2	1.00	0.700	0.937	1.000		-0.656	G	30.0 57.9
Qw3	1.00	0.686	0.937	1.000		-0.643	H	57.9
Qw4	1.00	-0.800	0.937	1.000		0.750	G	-30.0
Qw5	1.00	-0.800	0.937	1.000		0.750	H	-30.0
Qw6	1.00	-0.800	0.937	1.000		0.750	J	-30.0
Qw7	1.00	-0.600	0.937	1.000		0.562	I	-30.0
Qw8	1.00	-0.800	0.937	1.000	0.60	0.450	H	-30.0 30.0
Qw9	1.00	-0.600	0.937	1.000	0.60	0.337	I	-30.0
Qw10		-0.200	0.937	1.000		0.187	+i	
Qw11	1.00	0.400	0.937	1.000		-0.375	H	30.0
Qw12	1.00	-0.528	0.937	1.000	0.60	0.297	H	57.9

SNEEUW DAKTYPEN

StAAF	artikel
1-1	5.3.2 Lessenaarsdak
2-2	5.3.4 Dak met meer dan één overspanning
3-3	5.3.4 Dak met meer dan één overspanning
4-4	5.3.4 Dak met meer dan één overspanning
5-5	5.3.4 Dak met meer dan één overspanning
6-6	5.3.4 Dak met meer dan één overspanning

Project.....: 10745
 Onderdeel....: dsn schakeldak lage rand

SNEEUW DAKTYPEN

Staaft	artikel
7-7	5.3.4 Dak met meer dan één overspanning
8-8	5.3.2 Lessenaarsdak

Sneeuw indexen

Index	art	μ	s_k	red. posfac	breedte	Q_s	hoek
Qs1	5.3.2	0.057	0.70	1.00	1.000	0.040	57.9
Qs2	5.3.4	0.800	0.70	1.00	1.000	0.560	30.0
Qs3	5.3.2	0.800	0.70	1.00	1.000	0.560	30.0
Qs4	5.3.4	0.057	0.70	1.00	1.000	0.040	30.0
Qs5	5.3.4	1.600	0.70	1.00	1.000	1.120	30.0

BELASTINGGEVALLEN

B.G.	Omschrijving	Type
	1 Permanente belasting EGZ=0.00	1
g	2 Wind van links onderdruk A	7
g	3 Wind van links overdruk A	8
g	4 Wind van rechts onderdruk A	11
g	5 Wind van rechts overdruk A	12
g	6 Sneeuw A	22
g*	7 Sneeuw B	23

g = gegeneerd belastinggeval

* = belastinggeval bevat 1 of meer handmatig toegevoegde en/of gewijzigde lasten

BELASTINGGEVALLEN vervolg

B.G.	Omschrijving	Belastingduurklasse
	1 Permanente belasting	Blijvend
	2 Wind van links onderdruk A	Kort
	3 Wind van links overdruk A	Kort
	4 Wind van rechts onderdruk A	Kort
	5 Wind van rechts overdruk A	Kort
	6 Sneeuw A	Kort
	7 Sneeuw B	Kort

Project.....: 10745
 Onderdeel....: dsn schakeldak lage rand

BELASTINGEN

B.G:1 Permanente belasting

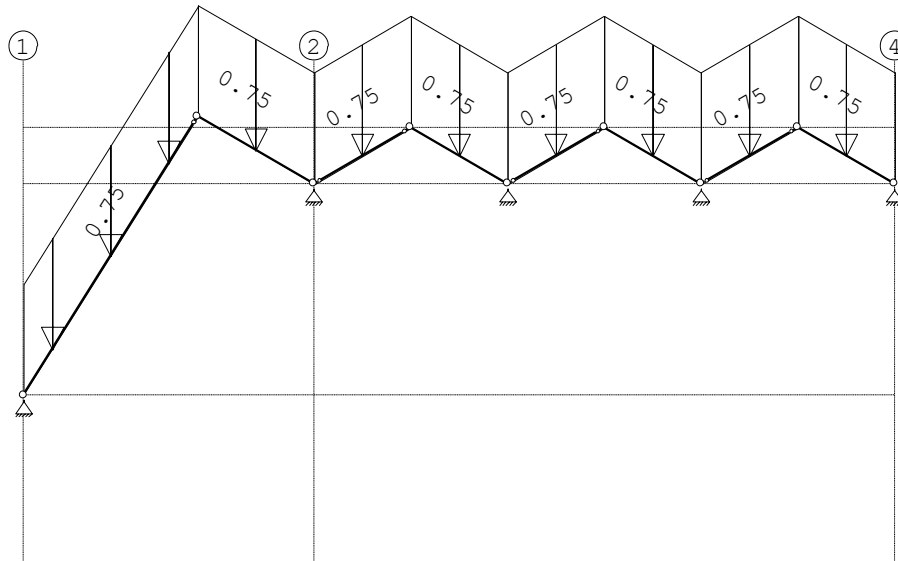

STAAFBELASTINGEN

B.G:1 Permanente belasting

Staat	Type	q1/p/m	q2	A	B	Ψ_0	Ψ_1	Ψ_2
1	5:QZGloaal	-0.75	-0.75	0.000	0.000			
2	5:QZGloaal	-0.75	-0.75	0.000	0.000			
3	5:QZGloaal	-0.75	-0.75	0.000	0.000			
4	5:QZGloaal	-0.75	-0.75	0.000	0.000			
5	5:QZGloaal	-0.75	-0.75	0.000	0.000			
6	5:QZGloaal	-0.75	-0.75	0.000	0.000			
7	5:QZGloaal	-0.75	-0.75	0.000	0.000			
8	5:QZGloaal	-0.75	-0.75	0.000	0.000			

Project.....: 10745
 Onderdeel....: dsn schakeldak lage rand

BELASTINGEN

B.G:2 Wind van links onderdruk A

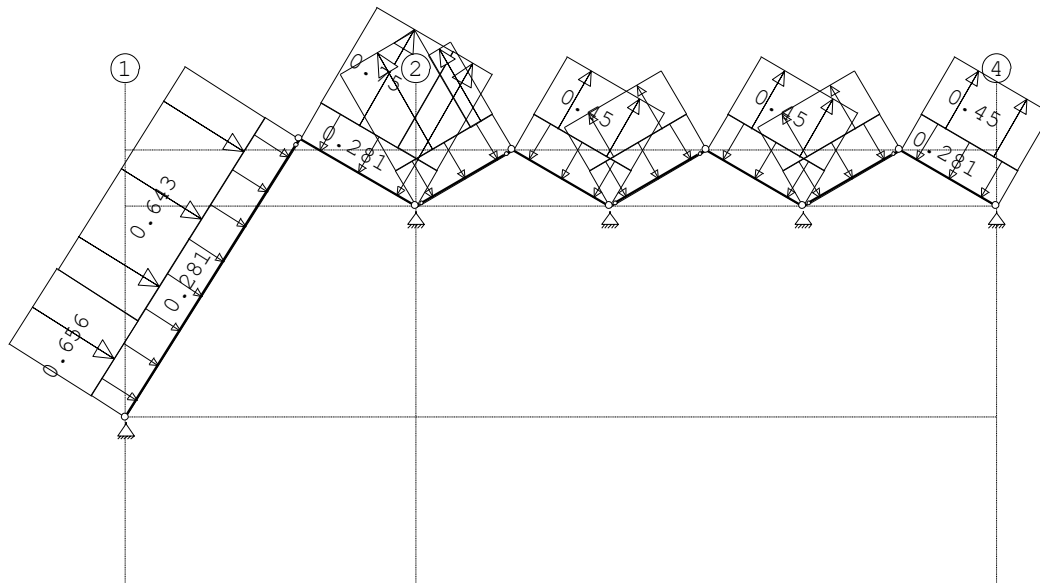

STAAFBELASTINGEN

B.G:2 Wind van links onderdruk A

StAAF	Type	Index	q1/p/m	q2	A	B	Ψ_0	Ψ_1	Ψ_2
1	1:QZLokaal	Qw1	-0.28	-0.28	0.000	0.000	0.00	0.20	0.00
2	1:QZLokaal	Qw1	-0.28	-0.28	0.000	0.000	0.00	0.20	0.00
3	1:QZLokaal	Qw1	-0.28	-0.28	0.000	0.000	0.00	0.20	0.00
4	1:QZLokaal	Qw1	-0.28	-0.28	0.000	0.000	0.00	0.20	0.00
5	1:QZLokaal	Qw1	-0.28	-0.28	0.000	0.000	0.00	0.20	0.00
6	1:QZLokaal	Qw1	-0.28	-0.28	0.000	0.000	0.00	0.20	0.00
7	1:QZLokaal	Qw1	-0.28	-0.28	0.000	0.000	0.00	0.20	0.00
8	1:QZLokaal	Qw1	-0.28	-0.28	0.000	0.000	0.00	0.20	0.00
1	1:QZLokaal	Qw2	-0.66	-0.66	0.000	4.318	0.00	0.20	0.00
1	1:QZLokaal	Qw3	-0.64	-0.64	1.602	0.000	0.00	0.20	0.00
2	1:QZLokaal	Qw4	0.75	0.75	0.000	0.822	0.00	0.20	0.00
2	1:QZLokaal	Qw5	0.75	0.75	1.602	0.000	0.00	0.20	0.00
3	1:QZLokaal	Qw6	0.75	0.75	0.000	0.459	0.00	0.20	0.00
3	1:QZLokaal	Qw7	0.56	0.56	1.562	0.000	0.00	0.20	0.00
4	1:QZLokaal	Qw8	0.45	0.45	0.000	0.000	0.00	0.20	0.00
5	1:QZLokaal	Qw9	0.34	0.34	0.000	0.000	0.00	0.20	0.00
6	1:QZLokaal	Qw8	0.45	0.45	0.000	0.000	0.00	0.20	0.00
7	1:QZLokaal	Qw9	0.34	0.34	0.000	0.000	0.00	0.20	0.00
8	1:QZLokaal	Qw8	0.45	0.45	0.000	0.000	0.00	0.20	0.00

Project.....: 10745
 Onderdeel....: dsn schakeldak lage rand

BELASTINGEN

B.G:3 Wind van links overdruk A

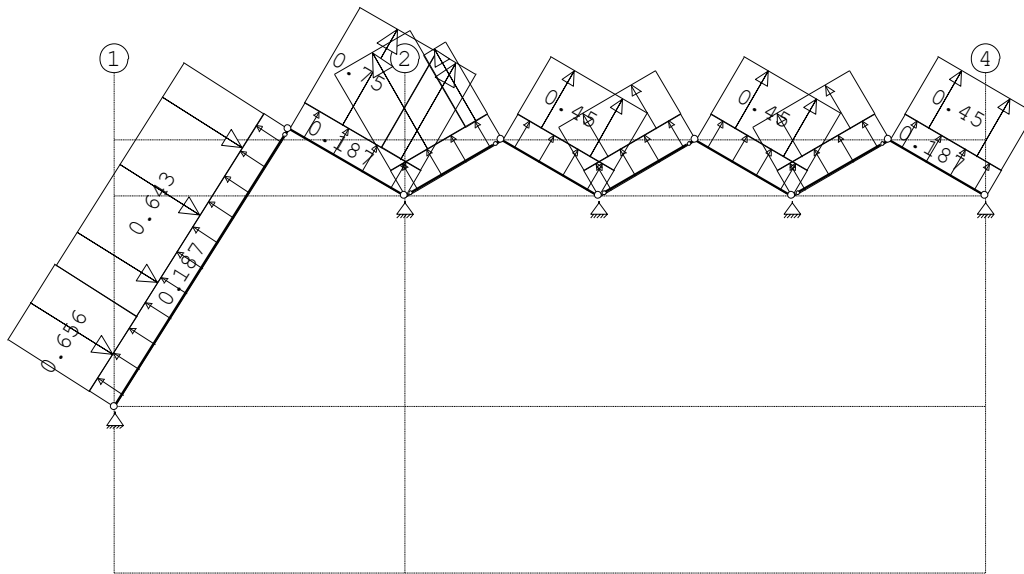

STAAFBELASTINGEN

B.G:3 Wind van links overdruk A

Staafl	Type	Index	q1/p/m	q2	A	B	ψ_0	ψ_1	ψ_2
1	1:QZLokaal	Qw10	0.19	0.19	0.000	0.000	0.00	0.20	0.00
2	1:QZLokaal	Qw10	0.19	0.19	0.000	0.000	0.00	0.20	0.00
3	1:QZLokaal	Qw10	0.19	0.19	0.000	0.000	0.00	0.20	0.00
4	1:QZLokaal	Qw10	0.19	0.19	0.000	0.000	0.00	0.20	0.00
5	1:QZLokaal	Qw10	0.19	0.19	0.000	0.000	0.00	0.20	0.00
6	1:QZLokaal	Qw10	0.19	0.19	0.000	0.000	0.00	0.20	0.00
7	1:QZLokaal	Qw10	0.19	0.19	0.000	0.000	0.00	0.20	0.00
8	1:QZLokaal	Qw10	0.19	0.19	0.000	0.000	0.00	0.20	0.00
1	1:QZLokaal	Qw2	-0.66	-0.66	0.000	4.318	0.00	0.20	0.00
1	1:QZLokaal	Qw3	-0.64	-0.64	1.602	0.000	0.00	0.20	0.00
2	1:QZLokaal	Qw4	0.75	0.75	0.000	0.822	0.00	0.20	0.00
2	1:QZLokaal	Qw5	0.75	0.75	1.602	0.000	0.00	0.20	0.00
3	1:QZLokaal	Qw6	0.75	0.75	0.000	0.459	0.00	0.20	0.00
3	1:QZLokaal	Qw7	0.56	0.56	1.562	0.000	0.00	0.20	0.00
4	1:QZLokaal	Qw8	0.45	0.45	0.000	0.000	0.00	0.20	0.00
5	1:QZLokaal	Qw9	0.34	0.34	0.000	0.000	0.00	0.20	0.00
6	1:QZLokaal	Qw8	0.45	0.45	0.000	0.000	0.00	0.20	0.00
7	1:QZLokaal	Qw9	0.34	0.34	0.000	0.000	0.00	0.20	0.00
8	1:QZLokaal	Qw8	0.45	0.45	0.000	0.000	0.00	0.20	0.00

Project.....: 10745
 Onderdeel....: dsn schakeldak lage rand

BELASTINGEN

B.G:4 Wind van rechts onderdruk A

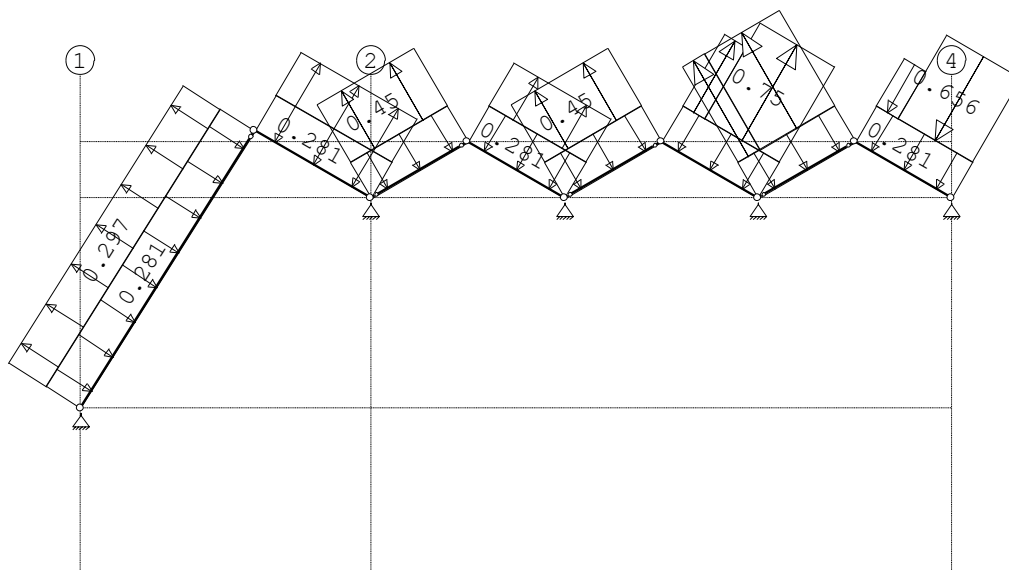

STAAFBELASTINGEN

B.G:4 Wind van rechts onderdruk A

Staaftype	Type	Index	q1/p/m	q2	A	B	ψ_0	ψ_1	ψ_2
1	1:QZLokaal	Qw1	-0.28	-0.28	0.000	0.000	0.00	0.20	0.00
2	1:QZLokaal	Qw1	-0.28	-0.28	0.000	0.000	0.00	0.20	0.00
3	1:QZLokaal	Qw1	-0.28	-0.28	0.000	0.000	0.00	0.20	0.00
4	1:QZLokaal	Qw1	-0.28	-0.28	0.000	0.000	0.00	0.20	0.00
5	1:QZLokaal	Qw1	-0.28	-0.28	0.000	0.000	0.00	0.20	0.00
6	1:QZLokaal	Qw1	-0.28	-0.28	0.000	0.000	0.00	0.20	0.00
7	1:QZLokaal	Qw1	-0.28	-0.28	0.000	0.000	0.00	0.20	0.00
8	1:QZLokaal	Qw1	-0.28	-0.28	0.000	0.000	0.00	0.20	0.00
8	1:QZLokaal	Qw2	-0.66	-0.66	0.459	0.000	0.00	0.20	0.00
8	1:QZLokaal	Qw11	-0.37	-0.37	0.000	1.562	0.00	0.20	0.00
7	1:QZLokaal	Qw4	0.75	0.75	0.459	0.000	0.00	0.20	0.00
7	1:QZLokaal	Qw5	0.75	0.75	0.000	1.562	0.00	0.20	0.00
6	1:QZLokaal	Qw6	0.75	0.75	0.459	0.000	0.00	0.20	0.00
6	1:QZLokaal	Qw7	0.56	0.56	0.000	1.562	0.00	0.20	0.00
5	1:QZLokaal	Qw8	0.45	0.45	0.000	0.000	0.00	0.20	0.00
4	1:QZLokaal	Qw9	0.34	0.34	0.000	0.000	0.00	0.20	0.00
3	1:QZLokaal	Qw8	0.45	0.45	0.000	0.000	0.00	0.20	0.00
2	1:QZLokaal	Qw9	0.34	0.34	0.000	0.000	0.00	0.20	0.00
1	1:QZLokaal	Qw12	0.30	0.30	0.000	0.000	0.00	0.20	0.00

Project.....: 10745
 Onderdeel....: dsn schakeldak lage rand

BELASTINGEN

B.G:5 Wind van rechts overdruk A

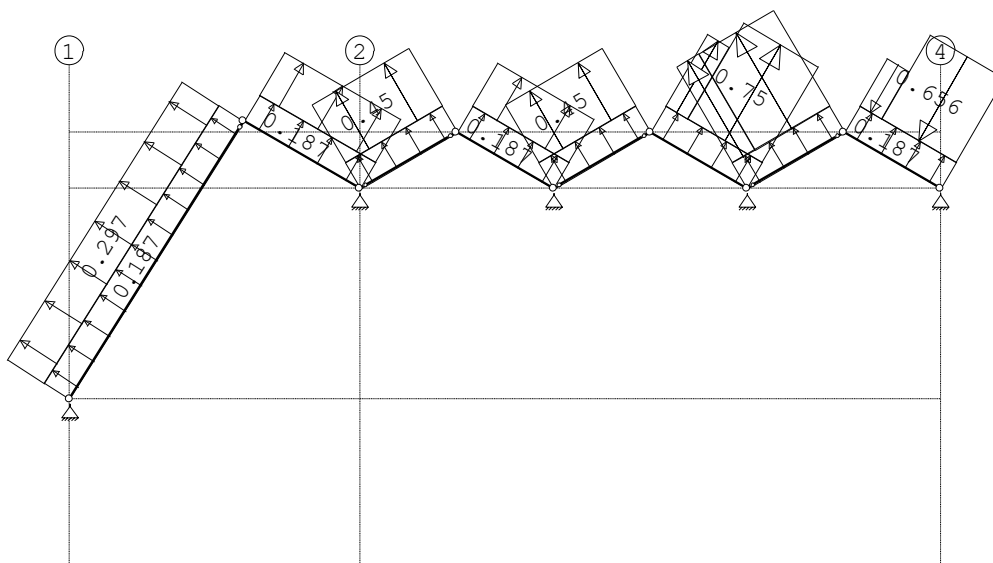

STAAFBELASTINGEN

B.G:5 Wind van rechts overdruk A

Staaftype	Type	Index	q1/p/m	q2	A	B	Ψ_0	Ψ_1	Ψ_2
1	1:QZLokaal	Qw10	0.19	0.19	0.000	0.000	0.00	0.20	0.00
2	1:QZLokaal	Qw10	0.19	0.19	0.000	0.000	0.00	0.20	0.00
3	1:QZLokaal	Qw10	0.19	0.19	0.000	0.000	0.00	0.20	0.00
4	1:QZLokaal	Qw10	0.19	0.19	0.000	0.000	0.00	0.20	0.00
5	1:QZLokaal	Qw10	0.19	0.19	0.000	0.000	0.00	0.20	0.00
6	1:QZLokaal	Qw10	0.19	0.19	0.000	0.000	0.00	0.20	0.00
7	1:QZLokaal	Qw10	0.19	0.19	0.000	0.000	0.00	0.20	0.00
8	1:QZLokaal	Qw10	0.19	0.19	0.000	0.000	0.00	0.20	0.00
8	1:QZLokaal	Qw2	-0.66	-0.66	0.459	0.000	0.00	0.20	0.00
8	1:QZLokaal	Qw11	-0.37	-0.37	0.000	1.562	0.00	0.20	0.00
7	1:QZLokaal	Qw4	0.75	0.75	0.459	0.000	0.00	0.20	0.00
7	1:QZLokaal	Qw5	0.75	0.75	0.000	1.562	0.00	0.20	0.00
6	1:QZLokaal	Qw6	0.75	0.75	0.459	0.000	0.00	0.20	0.00
6	1:QZLokaal	Qw7	0.56	0.56	0.000	1.562	0.00	0.20	0.00
5	1:QZLokaal	Qw8	0.45	0.45	0.000	0.000	0.00	0.20	0.00
4	1:QZLokaal	Qw9	0.34	0.34	0.000	0.000	0.00	0.20	0.00
3	1:QZLokaal	Qw8	0.45	0.45	0.000	0.000	0.00	0.20	0.00
2	1:QZLokaal	Qw9	0.34	0.34	0.000	0.000	0.00	0.20	0.00
1	1:QZLokaal	Qw12	0.30	0.30	0.000	0.000	0.00	0.20	0.00

Project.....: 10745
 Onderdeel....: dsn schakeldak lage rand

BELASTINGEN

B.G:6 Sneeuw A

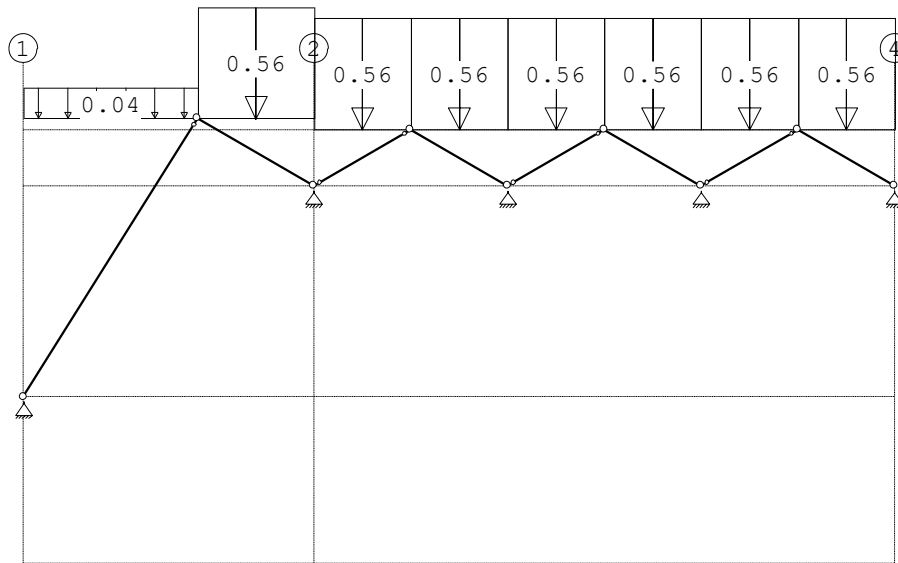

STAAFBELASTINGEN

B.G:6 Sneeuw A

Staatf	Type	Index	q1/p/m	q2	A	B	Ψ_0	Ψ_1	Ψ_2
1	3:QZgeProj.	Qs1	-0.04	-0.04	0.000	0.000	0.00	0.20	0.00
2	3:QZgeProj.	Qs2	-0.56	-0.56	0.000	0.000	0.00	0.20	0.00
3	3:QZgeProj.	Qs2	-0.56	-0.56	0.000	0.000	0.00	0.20	0.00
4	3:QZgeProj.	Qs2	-0.56	-0.56	0.000	0.000	0.00	0.20	0.00
5	3:QZgeProj.	Qs2	-0.56	-0.56	0.000	0.000	0.00	0.20	0.00
6	3:QZgeProj.	Qs2	-0.56	-0.56	0.000	0.000	0.00	0.20	0.00
7	3:QZgeProj.	Qs2	-0.56	-0.56	0.000	0.000	0.00	0.20	0.00
8	3:QZgeProj.	Qs3	-0.56	-0.56	0.000	0.000	0.00	0.20	0.00

Project.....: 10745
 Onderdeel....: dsn schakeldak lage rand

BELASTINGEN

B.G:7 Sneeuw B

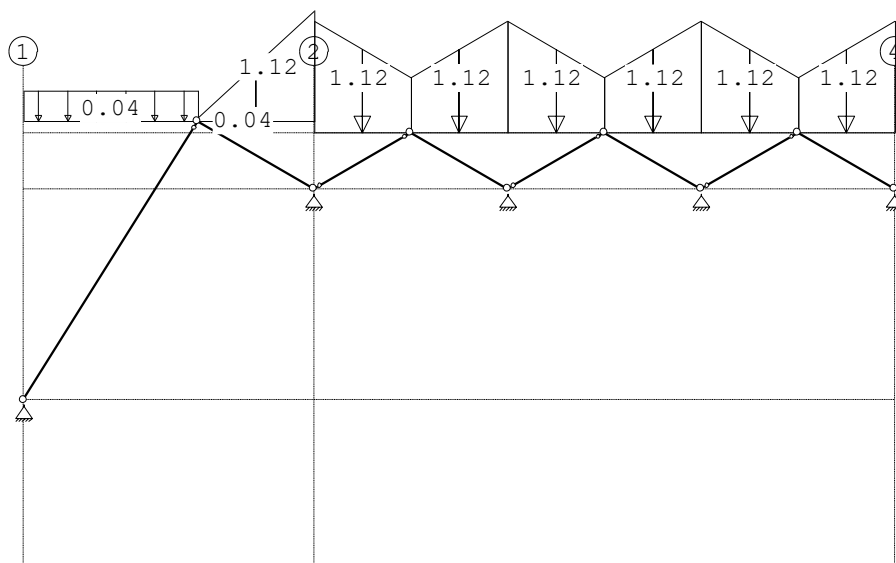

STAAFBELASTINGEN

B.G:7 Sneeuw B

Staaftype	Type	Index	q1/p/m	q2	A	B	Ψ_0	Ψ_1	Ψ_2
8	3:QZgeProj.	*	-0.56	-1.12	0.000	0.000	0.00	0.20	0.00
1	3:QZgeProj.	Qs1	-0.04	-0.04	0.000	0.000	0.00	0.20	0.00
2	3:QZgeProj.	Qs4	-0.04	-1.12	0.000	0.000	0.00	0.20	0.00
3	3:QZgeProj.	Qs5	-1.12	-0.56	0.000	0.000	0.00	0.20	0.00
4	3:QZgeProj.	Qs2	-0.56	-1.12	0.000	0.000	0.00	0.20	0.00
5	3:QZgeProj.	Qs5	-1.12	-0.56	0.000	0.000	0.00	0.20	0.00
6	3:QZgeProj.	Qs2	-0.56	-1.12	0.000	0.000	0.00	0.20	0.00
7	3:QZgeProj.	Qs5	-1.12	-0.56	0.000	0.000	0.00	0.20	0.00

Opmerkingen

[*] Deze belasting is handmatig toegevoegd of gewijzigd.

REACTIES 1e orde

Kn.	B.G.	X	Z	M
1	1	1.44	4.52	
1	2	-2.58	1.07	
1	3	-1.74	-0.19	
1	4	0.00	-0.08	
1	5	0.85	-1.35	
1	6	0.30	0.54	
1	7	0.22	0.42	
3	1	-0.13	3.26	
3	2	-2.78	0.25	
3	3	-2.31	-1.76	
3	4	-0.05	-0.31	
3	5	0.41	-2.33	
3	6	0.55	1.74	
3	7	0.91	2.40	

Project.....: 10745
 Onderdeel....: dsn schakeldak lage rand

REACTIES 1e orde

Kn.	B.G.	X	Z	M
5	1	0.00	3.03	
5	2	0.23	-0.59	
5	3	0.23	-2.23	
5	4	-0.23	-0.59	
5	5	-0.23	-2.23	
5	6	0.00	1.96	
5	7	-0.00	2.94	
7	1	0.00	3.03	
7	2	-0.11	-0.39	
7	3	-0.11	-2.03	
7	4	0.97	-0.68	
7	5	0.97	-2.32	
7	6	0.00	1.96	
7	7	0.00	2.94	
9	1	-1.31	1.52	
9	2	0.06	-0.23	
9	3	0.53	-1.05	
9	4	0.52	0.77	
9	5	1.00	-0.05	
9	6	-0.85	0.98	
9	7	-1.13	1.47	

BEREKENINGSTATUS

B.C.	Iteratie	Status
1	3	Nauwkeurigheid bereikt
2	3	Nauwkeurigheid bereikt
3	3	Nauwkeurigheid bereikt
4	3	Nauwkeurigheid bereikt
5	3	Nauwkeurigheid bereikt
6	3	Nauwkeurigheid bereikt
7	3	Nauwkeurigheid bereikt
8	3	Nauwkeurigheid bereikt
9	3	Nauwkeurigheid bereikt
10	3	Nauwkeurigheid bereikt
11	3	Nauwkeurigheid bereikt
12	3	Nauwkeurigheid bereikt
13	3	Nauwkeurigheid bereikt
14	3	Nauwkeurigheid bereikt
15	1	Lineaire berekening
16	1	Lineaire berekening
17	1	Lineaire berekening
18	1	Lineaire berekening
19	1	Lineaire berekening
20	1	Lineaire berekening
21	1	Lineaire berekening
22	1	Lineaire berekening

Project.....: 10745
Onderdeel....: dsn schakeldak lage rand

BELASTINGCOMBINATIES

BC	Type	BG	Gen.	Factor	BG	Gen.	Factor	BG	Gen.	Factor	BG	Gen.	Factor
1	Fund.	1	Perm	1.35									
2	Fund.	1	Perm	0.90									
3	Fund.	1	Perm	1.20	2	Extr	1.50						
4	Fund.	1	Perm	1.20	3	Extr	1.50						
5	Fund.	1	Perm	1.20	4	Extr	1.50						
6	Fund.	1	Perm	1.20	5	Extr	1.50						
7	Fund.	1	Perm	1.20	6	Extr	1.50						
8	Fund.	1	Perm	1.20	7	Extr	1.50						
9	Fund.	1	Perm	0.90	2	Extr	1.50						
10	Fund.	1	Perm	0.90	3	Extr	1.50						
11	Fund.	1	Perm	0.90	4	Extr	1.50						
12	Fund.	1	Perm	0.90	5	Extr	1.50						
13	Fund.	1	Perm	0.90	6	Extr	1.50						
14	Fund.	1	Perm	0.90	7	Extr	1.50						
15	Kar.	1	Perm	1.00	2	Extr	1.00						
16	Kar.	1	Perm	1.00	3	Extr	1.00						
17	Kar.	1	Perm	1.00	4	Extr	1.00						
18	Kar.	1	Perm	1.00	5	Extr	1.00						
19	Kar.	1	Perm	1.00	6	Extr	1.00						
20	Kar.	1	Perm	1.00	7	Extr	1.00						
21	Quas.	1	Perm	1.00									
22	Blij.	1	Perm	1.00									

GUNSTIGE WERKING PERMANENTE BELASTINGEN

BC	Staven met gunstige werking
1	Geen
2	Alle staven de factor:0.90
3	Geen
4	Geen
5	Geen
6	Geen
7	Geen
8	Geen
9	Alle staven de factor:0.90
10	Alle staven de factor:0.90
11	Alle staven de factor:0.90
12	Alle staven de factor:0.90
13	Alle staven de factor:0.90
14	Alle staven de factor:0.90

Project.....: 10745
Onderdeel.....: dsn schakeldak lage rand

OMHULLENDE VAN DE FUNDAMENTELE COMBINATIES

MOMENTEN

2e orde

Fundamentele combinatie

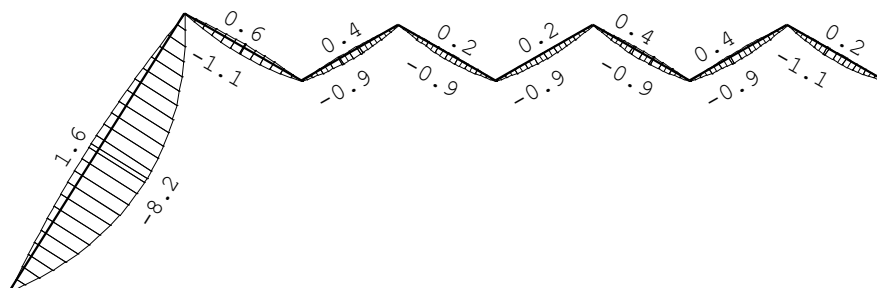

DWARSKRACHTEN

2e orde

Fundamentele combinatie

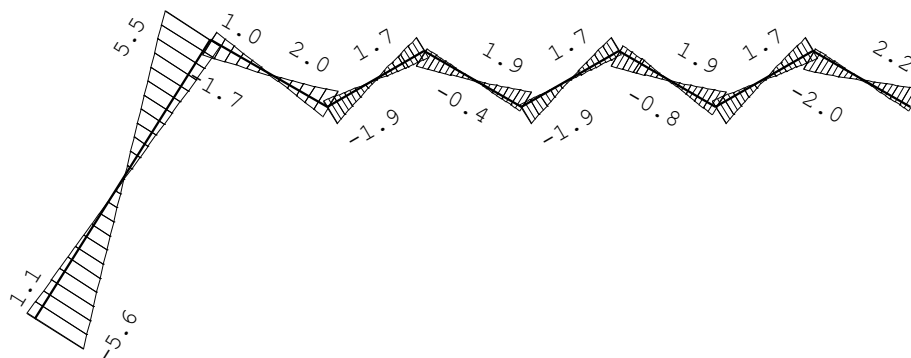

Project.....: 10745
 Onderdeel....: dsn schakeldak lage rand

NORMAALKRACHTEN

2e orde

Fundamentele combinatie

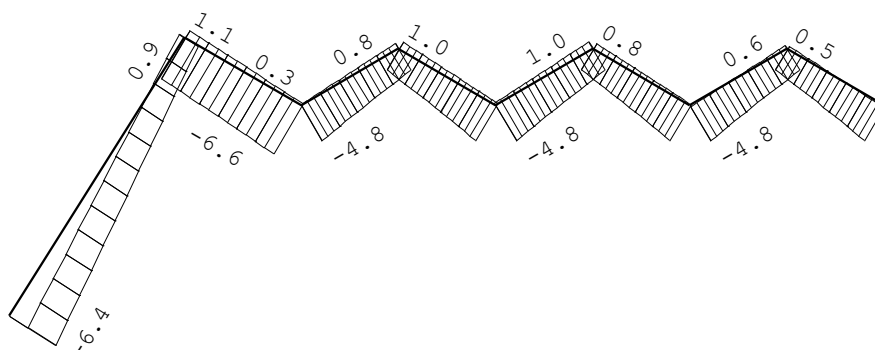

STAAFKRACHTEN

2e orde

Fundamentele combinatie

St.	Kn.	Pos.	NXi/NXj		DZi/DZj		MYi/MYj	
			Min	Max	Min	Max	Min	Max
1	1		-6.43	-2.48	-5.61	1.09	0.00	0.00
1		2.960	-4.10	-0.80	-0.00	0.02	-8.23	1.62
1		3.042	-4.04	-0.75	-0.03	0.17	-8.25	1.61
1	2		-1.76	0.91	-1.09	5.54	0.00	0.00
2	2		-5.55	1.10	-1.71	1.00	0.00	0.00
2		1.202	-6.09	0.69	-0.14	0.01	-1.05	0.60
2		1.212	-6.09	0.69	-0.12	0.00	-1.05	0.60
2	3		-6.64	0.28	-1.00	1.98	0.00	0.00
3	3		-4.84	0.17	-1.87	0.81	0.00	0.00
3		0.808	-3.96	0.44	-0.31	0.15	-0.87	0.39
3		0.808	-3.96	0.44	-0.30	0.15	-0.87	0.39
3		1.010	-3.76	0.51	-0.01	0.05	-0.86	0.39
3		1.172	-3.60	0.56	-0.15	0.33	-0.85	0.39
3	4		-2.83	0.85	-0.71	1.65	0.00	0.00
4	4		-2.83	1.04	-1.65	0.37	0.00	0.00
4		1.010	-3.76	0.70	-0.05	0.00	-0.86	0.18
4		1.212	-3.96	0.63	-0.07	0.30	-0.87	0.18
4		1.212	-3.96	0.63	-0.07	0.31	-0.87	0.18
4	5		-4.84	0.36	-0.37	1.87	0.00	0.00
5	5		-4.84	0.36	-1.87	0.37	0.00	0.00
5		0.808	-3.96	0.63	-0.31	0.07	-0.87	0.18
5		0.808	-3.96	0.63	-0.30	0.07	-0.87	0.18
5		1.010	-3.76	0.70	-0.00	0.05	-0.86	0.18
5		1.212	-3.55	0.77	-0.08	0.40	-0.85	0.18
5	6		-2.83	1.04	-0.37	1.65	0.00	0.00

Project.....: 10745
 Onderdeel....: dsn schakeldak lage rand

STAAFKRACHTEN			2e orde						Fundamentele combinatie					
St.	Kn.	Pos.	NXi/NXj		DZi/DZj		MYi/MYj							
			Min	BC	Max	BC	Min	BC	Max	BC	Min	BC	Max	BC
6	6		-2.83	8	0.85	12	-1.65	8	0.71	12	0.00	1	0.00	1
6		0.849	-3.60	8	0.56	12	-0.33	8	0.15	12	-0.85	8	0.39	12
6		1.010	-3.76	8	0.51	12	-0.05	8	0.01	12	-0.86	8	0.39	12
6		1.212	-3.96	8	0.44	12	-0.15	12	0.30	8	-0.87	8	0.39	12
6		1.212	-3.96	8	0.44	12	-0.15	12	0.31	8	-0.87	8	0.39	12
6		7	-4.84	8	0.17	12	-0.81	12	1.87	8	0.00	7	0.00	2
7	7		-4.84	8	-0.13	10	-1.87	8	0.83	12	0.00	1	0.00	1
7		0.808	-3.96	8	0.14	10	-0.31	8	0.17	12	-0.87	8	0.40	12
7		0.808	-3.96	8	0.14	10	-0.30	8	0.17	12	-0.87	8	0.40	12
7		0.849	-3.92	8	0.16	10	-0.24	8	0.14	12	-0.86	8	0.41	12
7		1.010	-3.76	8	0.21	10	-0.00	6	0.05	8	-0.86	8	0.41	12
7		8	-2.83	8	0.55	10	-0.83	12	1.65	8	0.00	3	0.00	6
8	8		-2.83	8	0.45	10	-2.04	5	0.38	10	0.00	1	0.00	1
8		0.849	-3.60	8	0.17	10	-0.38	5	0.06	10	-1.07	5	0.18	10
8		1.010	-3.76	8	0.11	10	-0.05	8	0.00	10	-1.06	5	0.18	10
8		1.212	-3.96	8	0.04	10	-0.07	10	0.42	5	-1.05	5	0.18	10
8		9	-4.84	8	-0.23	10	-0.38	10	2.20	5	0.00	5	0.00	6

REACTIES		2e orde				Fundamentele combinatie	
Kn.	X-min	X-max	Z-min	Z-max	M-min	M-max	
1	-2.56	3.00	2.04	7.02			
3	-4.33	1.25	-0.56	7.51			
5	-0.34	0.34	-0.62	8.05			
7	-0.17	1.46	-0.75	8.05			
9	-3.28	0.31	-0.21	4.02			

Project.....: 10745
 Onderdeel....: dsn schakeldak lage rand

OMHULLENDE VAN DE KARAKTERISTIEKE COMBINATIES

VERPLAATSINGEN 1e orde [mm] Karakteristieke combinatie

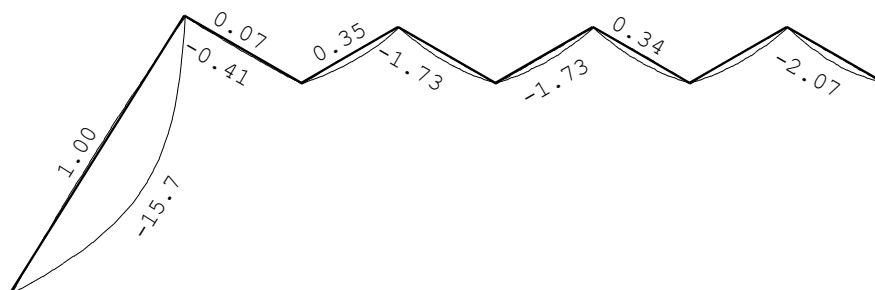

MATERIAALGEGEVENS

Mt	Kwaliteit	$f_{m,y,k}$ [N/mm ²]	ρ_k [kg/m ³]	ρ_{mean} [kg/m ³]	$f_{t,0,k}$ [N/mm ²]	$f_{t,90,k}$ [N/mm ²]	$f_{c,0,k}$ [N/mm ²]	$f_{c,90,k}$ [N/mm ²]	$f_{v,k}$ [N/mm ²]
1	C24	24	350	420	14.5	0.4	21.0	2.5	4.0

MATERIAALGEGEVENS (vervolg)

Mt	Kwaliteit	G_{mean} [N/mm ²]	$E_{0,05}$ [N/mm ²]	$E_{90,mean}$ [N/mm ²]	$E_{0,mean}$ [N/mm ²]	Klimaatklasse	k_{def}	$E_{0,mean,fin}$ [N/mm ²]
1	C24	690	7400	370	11000	I	0.60	6875

KIPSTABILITEIT

StAAF	Plts. aangr.	l sys. [m]	Kipsteunafstanden [m]
1	1.0*h	boven:	5.92 5*.987;0.985
		onder:	5.92 0;5.920
2	1.0*h	boven:	2.42 0;2*1.212
		onder:	2.42 0;2.425
3	1.0*h	boven:	2.02 0;2.021
		onder:	2.02 0;2.021
4	1.0*h	boven:	2.02 0;2.021
		onder:	2.02 0;2.021
5	1.0*h	boven:	2.02 0;2.021
		onder:	2.02 0;2.021
6	1.0*h	boven:	2.02 0;2.021
		onder:	2.02 0;2.021
7	1.0*h	boven:	2.02 0;2.021
		onder:	2.02 0;2.021
8	1.0*h	boven:	2.02 0;2.021
		onder:	2.02 0;2.021

STABILITEIT

Stf	b_{gem} [mm]	h_{gem} [mm]	l_{sys} [mm]	$l_{buc,y/z}$ [mm]	λ_y	λ_z	$\lambda_{rel,y/z}$	β_c	k_y	k_z	$k_{c,y}$	$k_{c,z}$
-----	-------------------	-------------------	-------------------	-----------------------	-------------	-------------	---------------------	-----------	-------	-------	-----------	-----------

Project.....: 10745
 Onderdeel....: dsn schakeldak lage rand

STABILITEIT

Stf	b _{gem} [mm]	h _{gem} [mm]	l _{sys} [mm]	l _{buc, y/z} [mm]		λ _y	λ _z	λ _{rel, y/z}	β _c	k _y	k _z	k _{c, y}	k _{c, z}	
1	63	286	5920	nvt	500	71.7	27.5	1.216	0.466	0.2	1.331	0.625	0.534	0.960
2	63	286	2425	nvt	500	29.4	27.5	0.498	0.466	0.2	0.644	0.625	0.951	0.960
3	63	140	2021	nvt	500	50.0	27.5	0.848	0.466	0.2	0.914	0.625	0.796	0.960
4	63	140	2021	nvt	500	50.0	27.5	0.848	0.466	0.2	0.914	0.625	0.796	0.960
5	63	140	2021	nvt	500	50.0	27.5	0.848	0.466	0.2	0.914	0.625	0.796	0.960
6	63	140	2021	nvt	500	50.0	27.5	0.848	0.466	0.2	0.914	0.625	0.796	0.960
7	63	140	2021	nvt	500	50.0	27.5	0.848	0.466	0.2	0.914	0.625	0.796	0.960
8	63	140	2021	nvt	500	50.0	27.5	0.848	0.466	0.2	0.914	0.625	0.796	0.960

STABILITEIT (vervolg)

Staf	positie [mm]	l _{ef, y} [mm]	σ _{my, crit} [N/mm ²]	λ _{rel, my}	k _{crit, y}
1	3041	1559	51.38	0.68	1.00
2	1212	1663	48.17	0.71	1.00
3	808	2099	77.96	0.55	1.00
4	1212	2099	77.96	0.55	1.00
5	808	2099	77.96	0.55	1.00
6	1212	2099	77.96	0.55	1.00
7	808	2099	77.96	0.55	1.00
8	849	2099	77.96	0.55	1.00

TOETSING SPANNINGEN

Staf	1	BC / Sit.	3 / 1	UC frm(6.23)	0.60
Staf	2	BC / Sit.	8 / 1	UC frm(6.23)	0.08
Staf	3	BC / Sit.	8 / 1	UC frm(6.23)	0.29
Staf	4	BC / Sit.	8 / 1	UC frm(6.23)	0.29
Staf	5	BC / Sit.	8 / 1	UC frm(6.23)	0.29
Staf	6	BC / Sit.	8 / 1	UC frm(6.23)	0.29
Staf	7	BC / Sit.	8 / 1	UC frm(6.23)	0.29
Staf	8	BC / Sit.	5 / 1	UC frm(6.23)	0.32

TOETSING DOORBUIGING

Stf	Soort	Mtg	l _{sys} [mm]	Overstek i j	BC Sit	u _{bij} [mm]	Toelaatbaar [mm]	u _{fin, net} [mm]	Toelaatbaar [mm]		
1	Dak	db	5920	Nee Nee	21 1	-13.7	-23.7	0.004	-18.4	-23.7	0.004
2	Dak	db	2425	Nee Nee	21 1	-0.3	-9.7	0.004	-0.5	-9.7	0.004
3	Dak	db	2021	Nee Nee	21 1	-1.3	-8.1	0.004	-2.2	-8.1	0.004
4	Dak	db	2021	Nee Nee	21 1	-1.3	-8.1	0.004	-2.2	-8.1	0.004
5	Dak	db	2021	Nee Nee	21 1	-1.3	-8.1	0.004	-2.2	-8.1	0.004
6	Dak	db	2021	Nee Nee	21 1	-1.3	-8.1	0.004	-2.2	-8.1	0.004
7	Dak	db	2021	Nee Nee	21 1	-1.3	-8.1	0.004	-2.2	-8.1	0.004
8	Dak	db	2021	Nee Nee	21 1	-1.7	-8.1	0.004	-2.6	-8.1	0.004

TOETSING DOORBUIGING (vervolg)

Stf	Soort	Mtg	l _{sys} [mm]	Overstek i j	Zeeg [mm]	BC Sit	u _{inst} [mm]	Toelaatbaar [mm]
								*1

Project.....: 10745

Onderdeel....: dsn schakeldak lage rand

TOETSING DOORBUIGING (vervolg)

Stf	Soort	Mtg	l_{sys} [mm]	Overstek i j	Zeeg [mm]	BC	Sit	u_{inst} [mm]	Toelaatbaar [mm]	*1
1	Dak	db	5920	Nee Nee	0.0	15	1	-15.7	-23.7	0.004
2	Dak	db	2425	Nee Nee	0.0	20	1	-0.4	-9.7	0.004
3	Dak	db	2021	Nee Nee	0.0	20	1	-1.7	-8.1	0.004
4	Dak	db	2021	Nee Nee	0.0	20	1	-1.7	-8.1	0.004
5	Dak	db	2021	Nee Nee	0.0	20	1	-1.7	-8.1	0.004
6	Dak	db	2021	Nee Nee	0.0	20	1	-1.7	-8.1	0.004
7	Dak	db	2021	Nee Nee	0.0	20	1	-1.7	-8.1	0.004
8	Dak	db	2021	Nee Nee	0.0	17	1	-2.1	-8.1	0.004

Sporen rand 38x286 mm² h.o.h. 610 mm

Overige sporen 38x140 mm² h.o.h. 610 mm

2.2 Ligger schakeldak

Verticaal

belasting

dak_schuin_fundering	$0.87 * (5.25+3.50)/2$	= 3.81 kN/m ¹
sneeuw_aang_gem	$(1.12+0.56)/2 * (5.25+3.50)/2$	= 3.68 kN/m ¹
of tussenligger met schuifwand		
dak_schuin_fundering	$0.87 * 3.50 + (0.70*3.00)$	= 5.15 kN/m ¹
sneeuw_aang_gem	$(1.12+0.56)/2 * 3.50$	= 2.94 kN/m ¹

Horizontaal

belasting

eg_uit_kn_3	0.13	= 0.13 kN/m ¹
vb_uit_kn_3	2.78	= 2.78 kN/m ¹

Technosoft Raamwerken release 6.84b

20 nov 2025

Project.....: 10745
 Onderdeel....: Liggers geschakeld dak
 Dimensies....: kN;m;rad (tenzij anders aangegeven)
 Bestand.....: N:\Order\10000\10700\10745\berekeningen en
 schetsen\Liggers geschakeld dak.rww

Belastingbreedte.: 1.000
 Rekenmodel.....: 2e-orde-elastisch.
 Theorieën voor de bepaling van de krachtsverdeling:
 1) Losse belastinggevallen:
 Lineaire-elasticiteitstheorie
 2) Uiterste grenstoestand:
 Geometrisch niet lineair alle staven.
 Fysisch lineair alle staven.
 3) Gebruiksgrenstoestand:
 Lineaire-elasticiteitstheorie

Maximum aantal iteraties.....: 50
 Max.deellengte kolommen/wanden: 0.500 Max.deellengte balken/vloeren: 0.500
 Max. X-verplaatsing in UGT.....: 0.500 Max. Z-verplaatsing in UGT....: 0.250

Gunstige werking van de permanente belasting wordt automatisch verwerkt.

Toegepaste normen volgens Eurocode met Nederlandse NB

Belastingen	NEN-EN 1990:2002	C2:2010,A1:2019	NB:2019(nl)
	NEN-EN 1991-1-1:2002	C1/C11:2019	NB:2019(nl)
	NEN-EN 1991-1-3:2003	A1:2019	NB:2019(nl)
Hout	NEN-EN 1995-1-1:2005	A2:2014,C1:2012	NB:2013(nl)
	NEN-EN 14080:2013		

GEOMETRIE

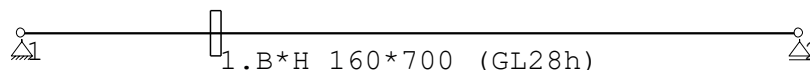

MATERIALEN

Mt	Kwaliteit	E-modulus [N/mm ²]	S.G.	S.G.verhoogd	Pois.	Uitz. coëff
1	GL28h	12600	4.2	5.1	1.00	5.0000e-06

Bij de bepaling v.h. e.g. van houten staven is de S.G.verhoogd toegepast.

PROFIELEN [mm]

Prof.	Omschrijving	Materiaal	Oppervlak	Traagheid	Vormf.
1	B*H 160*700	1:GL28h	1.1200e+05	4.5733e+09	0.00

PROFIELEN vervolg [mm]

Prof.	Staaftype	Breedte	Hoogte	e	Type	b1	h1	b2	h2
1	0:Normaal	160	700	350.0	0:RH				

Project.....: 10745
 Onderdeel....: Liggers geschakeld dak

PROFIELVORMEN [mm]

1 B*H 160*700



KNOPEN

Knoop	X	Z
1	0.000	0.000
2	11.350	0.000

STAVEN

St.	ki	kj	Profiel	Aansl.i	Aansl.j	Lengte	Opm.
1	1	2	1:B*H 160*700	NDM	NDM	11.350	

VASTE STEUNPUNTEN

Nr.	knoop	Kode	XZR	l=vast	0=vrij	Hoek
1	1	110				0.00
2	2	010				0.00

BELASTINGGEVALLEN

B.G.	Omschrijving	EGZ	Type
1	Permanente belasting	EGZ=-1.00	1
2	Sneeuw A		22

BELASTINGGEVALLEN vervolg

B.G.	Omschrijving	Belastingduurklasse
1	Permanente belasting	Blijvend
2	Sneeuw A	Kort

BELASTINGEN

B.G:1 Permanente belasting

Eigen gewicht van alle staven is meegenomen in berekening. Richting:↓

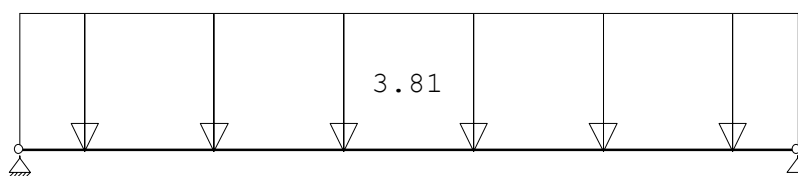

STAAFBELASTINGEN

B.G:1 Permanente belasting

StAAF	Type	q1/p/m	q2	A	B	ψ ₀	ψ ₁	ψ ₂
1	5:QZGlobaal	-3.81	-3.81	0.000	0.000			

Project.....: 10745
 Onderdeel....: Liggers geschakeld dak

BELASTINGEN

B.G:2 Sneeuw A

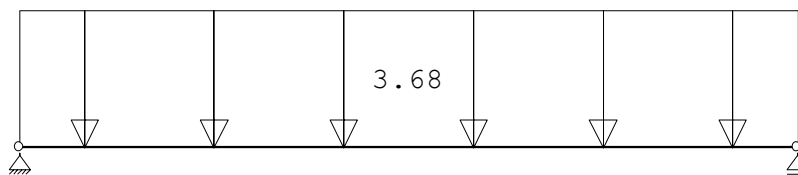

STAAFBELASTINGEN

B.G:2 Sneeuw A

StAAF Type	q1/p/m	q2	A	B	Ψ_0	Ψ_1	Ψ_2
1 3:QZgeProj.	-3.68	-3.68	0.000	0.000	0.00	0.20	0.00

REACTIES 1e orde

Kn.	B.G.	X	Z	M
1	1	0.00	24.86	
1	2	0.00	20.88	
2	1		24.86	
2	2		20.88	

BEREKENINGSTATUS

B.C.	Iteratie	Status
1	3	Nauwkeurigheid bereikt
2	3	Nauwkeurigheid bereikt
3	3	Nauwkeurigheid bereikt
4	3	Nauwkeurigheid bereikt
5	1	Lineaire berekening
6	1	Lineaire berekening
7	1	Lineaire berekening

BELASTINGCOMBINATIES

BC Type	BG	Gen. Factor	BG	Gen. Factor	BG	Gen. Factor	BG	Gen. Factor
1 Fund.	1 Perm	1.35						
2 Fund.	1 Perm	0.90						
3 Fund.	1 Perm	1.20	2 Extr	1.50				
4 Fund.	1 Perm	0.90	2 Extr	1.50				
5 Kar.	1 Perm	1.00	2 Extr	1.00				
6 Quas.	1 Perm	1.00						
7 Blij.	1 Perm	1.00						

GUNSTIGE WERKING PERMANENTE BELASTINGEN

BC Staven met gunstige werking
1 Geen
2 Alle staven de factor:0.90
3 Geen
4 Alle staven de factor:0.90

Project.....: 10745
 Onderdeel....: Liggers geschakeld dak

OMHULLENDE VAN DE FUNDAMENTELE COMBINATIES

MOMENTEN 2e orde Fundamentele combinatie

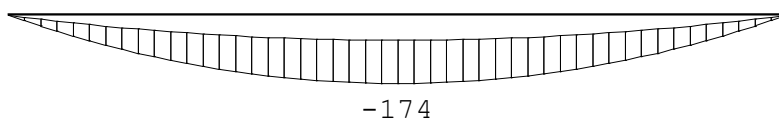

DWARSKRACHTEN 2e orde Fundamentele combinatie

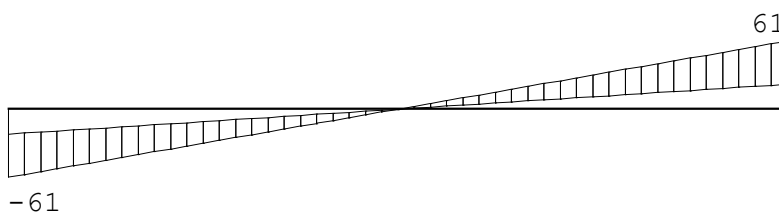

STAAFKRACHTEN 2e orde Fundamentele combinatie

St.	Kn.	Pos.	NXi/NXj			DZi/DZj			MYi/MYj					
			Min	BC	Max	BC	Min	BC	Max	BC	Min	BC	Max	BC
1	1		0.12	2	0.87	3	-61.16	3	-22.38	2	-0.00	4	0.00	3
1		5.675	0.00	4	0.00	3	0.00	2	0.00	3	-173.54	3	-63.49	2
1	2		0.12	2	0.87	3	22.38	2	61.16	3	0.00	1	0.00	3

REACTIES 2e orde Fundamentele combinatie

Kn.	X-min	X-max	Z-min	Z-max	M-min	M-max
1	0.00	0.00	22.38	61.16		
2			22.38	61.16		

MATERIAALGEGEVENS

Mt	Kwaliteit	$f_{m,y,k}$ [N/mm ²]	ρ_k [kg/m ³]	ρ_{mean} [kg/m ³]	$f_{t,0,k}$ [N/mm ²]	$f_{t,90,k}$ [N/mm ²]	$f_{c,0,k}$ [N/mm ²]	$f_{c,90,k}$ [N/mm ²]	$f_{v,k}$ [N/mm ²]
1	GL28h	28	425	460	22.3	0.5	28.0	2.5	3.5

MATERIAALGEGEVENS (vervolg)

Mt	Kwaliteit	G_{mean} [N/mm ²]	$E_{0,05}$ [N/mm ²]	$E_{90,mean}$ [N/mm ²]	$E_{0,mean}$ [N/mm ²]	Klimaatklasse	k_{def}	$E_{0,mean,fin}$ [N/mm ²]
1	GL28h	650	10500	300	12600	I	0.60	7875

KIPSTABILITEIT

StAAF	Plts. aangr.	1 sys.	Kipsteunafstanden	
			[m]	[m]
1	1.0*h	boven:	11.35	3*2.838;2.836
		onder:	11.35	0;11.350

Project.....: 10745
 Onderdeel....: Liggers geschakeld dak

STABILITEIT

Stf	b_{gem} [mm]	h_{gem} [mm]	l_{sys} [mm]	$l_{buc,y/z}$ [mm]	λ_y	λ_z	$\lambda_{rel,y/z}$	β_c	k_y	k_z	$k_{c,y}$	$k_{c,z}$		
1	160	700	11350	nvt	3000	56.2	65.0	0.923	1.068	0.1	0.957	1.108	0.826	0.711

STABILITEIT (vervolg)

Staf	positie [mm]	$l_{ef,y}$ [mm]	$\sigma_{my,crit}$ [N/mm ²]	$\lambda_{rel,my}$	$k_{crit,y}$
1	5675	4238	70.67	0.63	1.00

TOETSING SPANNINGEN

Staf	1	BC / Sit.	3 / 1	UC frm(6.11)	0.66
------	---	-----------	-------	--------------	------

TOETSING DOORBUIGING

Stf	Soort	Mtg	l_{sys} [mm]	Overstek i j	BC	Sit	u_{bij} [mm]	Toelaatbaar [mm]	$u_{fin,net}$ [mm]	Toelaatbaar [mm]		
1	Dak	db	11350	Nee Nee	6	1	-23.7	-45.4	0.004	-40.1	-45.4	0.004

TOETSING DOORBUIGING (vervolg)

Stf	Soort	Mtg	l_{sys} [mm]	Overstek i j	Zeeg [mm]	BC	Sit	u_{inst} [mm]	Toelaatbaar [mm]	
1	Dak	db	11350	Nee Nee	0.0	5	1	-30.2	-45.4	0.004

Project.....: 10745
 Onderdeel....: Liggers geschakeld dak
 Dimensies....: kN;m;rad (tenzij anders aangegeven)
 Bestand.....: N:\Order\10000\10700\10745\berekeningen en
 schetsen\Liggers geschakeld dak met schuifwand.rww

Belastingbreedte.: 1.000
 Rekenmodel.....: 2e-orde-elastisch.
 Theorieën voor de bepaling van de krachtsverdeling:
 1) Losse belastinggevallen:
 Lineaire-elasticiteitstheorie
 2) Uiterste grenstoestand:
 Geometrisch niet lineair alle staven.
 Fysisch lineair alle staven.
 3) Gebruiksgrenstoestand:
 Lineaire-elasticiteitstheorie

Maximum aantal iteraties.....: 50
 Max.deellengte kolommen/wanden: 0.500 Max.deellengte balken/vloeren: 0.500
 Max. X-verplaatsing in UGT.....: 0.500 Max. Z-verplaatsing in UGT...: 0.250

Gunstige werking van de permanente belasting wordt automatisch verwerkt.

Toegepaste normen volgens Eurocode met Nederlandse NB

Belastingen	NEN-EN 1990:2002	C2:2010,A1:2019	NB:2019(nl)
	NEN-EN 1991-1-1:2002	C1/C11:2019	NB:2019(nl)
	NEN-EN 1991-1-3:2003	A1:2019	NB:2019(nl)
Hout	NEN-EN 1995-1-1:2005	A2:2014,C1:2012	NB:2013(nl)
	NEN-EN 14080:2013		

GEOMETRIE

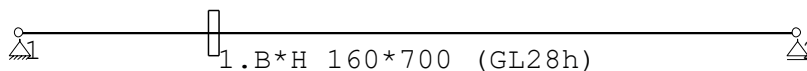

MATERIALEN

Mt	Kwaliteit	E-modulus[N/mm ²]	S.G.	S.G.verhoogd	Pois.	Uitz. coëff
1	GL28h	12600	4.2	5.1	1.00	5.0000e-06

Bij de bepaling v.h. e.g. van houten staven is de S.G.verhoogd toegepast.

PROFIELEN [mm]

Prof.	Omschrijving	Materiaal	Oppervlak	Traagheid	Vormf.
1	B*H 160*700	1:GL28h	1.1200e+05	4.5733e+09	0.00

PROFIELEN vervolg [mm]

Prof.	Staaftype	Breedte	Hoogte	e	Type	b1	h1	b2	h2
1	0:Normaal	160	700	350.0	0:RH				

Project.....: 10745
 Onderdeel....: Liggers geschakeld dak

PROFIELVORMEN [mm]

1 B*H 160*700



KNOPEN

Knoop	X	Z
1	0.000	0.000
2	11.350	0.000

STAVEN

St.	ki	kj	Profiel	Aansl.i	Aansl.j	Lengte	Opm.
1	1	2	1:B*H 160*700	NDM	NDM	11.350	

VASTE STEUNPUNTEN

Nr.	knoop	Kode	XZR	l=vast	0=vrij	Hoek
1	1	110				0.00
2	2	010				0.00

BELASTINGGEVALLEN

B.G.	Omschrijving	EGZ	Type
1	Permanente belasting	-1.00	1
2	Sneeuw A		22

BELASTINGGEVALLEN vervolg

B.G.	Omschrijving	Belastingduurklasse
1	Permanente belasting	Blijvend
2	Sneeuw A	Kort

BELASTINGEN

B.G:1 Permanente belasting

Eigen gewicht van alle staven is meegenomen in berekening. Richting:↓

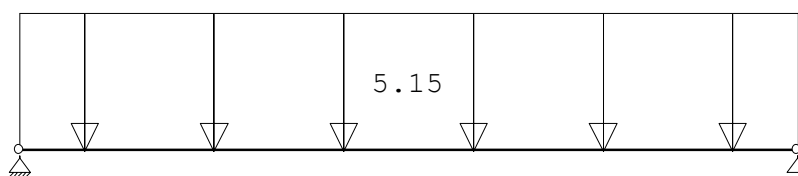

STAAFBELASTINGEN

B.G:1 Permanente belasting

StAAF	Type	q1/p/m	q2	A	B	Ψ ₀	Ψ ₁	Ψ ₂
1	5:QZGloobaal	-5.15	-5.15	0.000	0.000			

Project.....: 10745
 Onderdeel....: Liggers geschakeld dak

BELASTINGEN

B.G:2 Sneeuw A

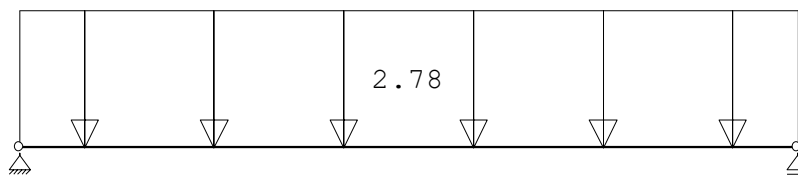

STAAFBELASTINGEN

B.G:2 Sneeuw A

StAAF Type	q1/p/m	q2	A	B	Ψ_0	Ψ_1	Ψ_2
1 3:QZgeProj.	-2.78	-2.78	0.000	0.000	0.00	0.20	0.00

REACTIES 1e orde

Kn.	B.G.	X	Z	M
1	1	0.00	32.47	
1	2	0.00	15.78	
2	1		32.47	
2	2		15.78	

BEREKENINGSTATUS

B.C.	Iteratie	Status
1	3	Nauwkeurigheid bereikt
2	3	Nauwkeurigheid bereikt
3	3	Nauwkeurigheid bereikt
4	3	Nauwkeurigheid bereikt
5	1	Lineaire berekening
6	1	Lineaire berekening
7	1	Lineaire berekening

BELASTINGCOMBINATIES

BC Type	BG	Gen. Factor	BG	Gen. Factor	BG	Gen. Factor	BG	Gen. Factor
1 Fund.	1 Perm	1.35						
2 Fund.	1 Perm	0.90						
3 Fund.	1 Perm	1.20	2 Extr	1.50				
4 Fund.	1 Perm	0.90	2 Extr	1.50				
5 Kar.	1 Perm	1.00	2 Extr	1.00				
6 Quas.	1 Perm	1.00						
7 Blij.	1 Perm	1.00						

GUNSTIGE WERKING PERMANENTE BELASTINGEN

BC	Staven met gunstige werking
1	Geen
2	Alle staven de factor:0.90
3	Geen
4	Alle staven de factor:0.90

Project.....: 10745
 Onderdeel....: Liggers geschakeld dak

OMHULLENDE VAN DE FUNDAMENTELE COMBINATIES

MOMENTEN 2e orde Fundamentele combinatie

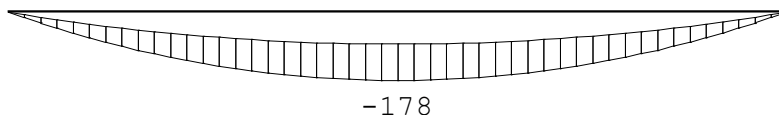

DWARSKRACHTEN 2e orde Fundamentele combinatie

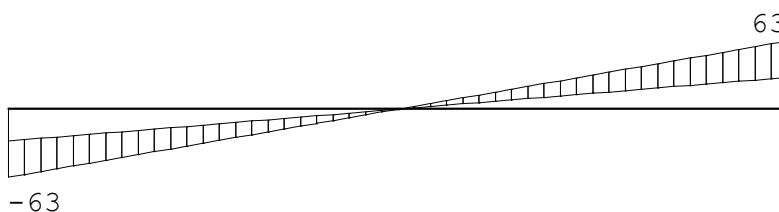

STAAFKRACHTEN 2e orde Fundamentele combinatie

St.	Kn.	Pos.	NXi/NXj			DZi/DZj			MYi/MYj					
			Min	BC	Max	Min	BC	Max	Min	BC	Max			
1	1		0.20	2	0.91	3	-62.62	3	-29.22	2	-0.00	2	0.00	3
1	5.675		0.00	2	0.00	3	0.00	2	0.00	1	-177.69	3	-82.91	2
1	2		0.20	2	0.91	3	29.22	2	62.62	3	0.00	2	0.00	3

REACTIES 2e orde Fundamentele combinatie

Kn.	X-min	X-max	Z-min	Z-max	M-min	M-max
1	0.00	0.00	29.22	62.63		
2			29.22	62.63		

MATERIAALGEGEVENS

Mt	Kwaliteit	$f_{m,y,k}$ [N/mm ²]	ρ_k [kg/m ³]	ρ_{mean} [kg/m ³]	$f_{t,0,k}$ [N/mm ²]	$f_{t,90,k}$ [N/mm ²]	$f_{c,0,k}$ [N/mm ²]	$f_{c,90,k}$ [N/mm ²]	$f_{v,k}$ [N/mm ²]
1	GL28h	28	425	460	22.3	0.5	28.0	2.5	3.5

MATERIAALGEGEVENS (vervolg)

Mt	Kwaliteit	G_{mean} [N/mm ²]	$E_{0,05}$ [N/mm ²]	$E_{90,mean}$ [N/mm ²]	$E_{0,mean}$ [N/mm ²]	Klimaatklasse	k_{def}	$E_{0,mean,fin}$ [N/mm ²]
1	GL28h	650	10500	300	12600	I	0.60	7875

KIPSTABILITEIT

StAAF	Plts. aangr.	1 sys.	Kipsteunafstanden	
			[m]	[m]
1	1.0*h	boven:	11.35	3*2.838;2.836
		onder:	11.35	0;11.350

Project.....: 10745
 Onderdeel....: Liggers geschakeld dak

STABILITEIT

Stf	b_{gem} [mm]	h_{gem} [mm]	l_{sys} [mm]	$l_{buc,y/z}$ [mm]	λ_y	λ_z	$\lambda_{rel,y/z}$	β_c	k_y	k_z	$k_{c,y}$	$k_{c,z}$		
1	160	700	11350	nvt	3000	56.2	65.0	0.923	1.068	0.1	0.957	1.108	0.826	0.711

STABILITEIT (vervolg)

Staf	positie [mm]	$l_{ef,y}$ [mm]	$\sigma_{my,crit}$ [N/mm ²]	$\lambda_{rel,my}$	$k_{crit,y}$
1	5675	4238	70.67	0.63	1.00

TOETSING SPANNINGEN

Staf	1	BC / Sit.	1 / 1	UC frm(6.11)	0.71
------	---	-----------	-------	--------------	------

TOETSING DOORBUIGING

Stf	Soort	Mtg	l_{sys} [mm]	Overstek i j	BC	Sit	u_{bij} [mm]	Toelaatbaar [mm]	$u_{fin,net}$ [mm]	Toelaatbaar [mm]		
1	Dak	db	11350	Nee Nee	6	1	-23.3	-45.4	0.004	-44.8	-45.4	0.004

TOETSING DOORBUIGING (vervolg)

Stf	Soort	Mtg	l_{sys} [mm]	Overstek i j	Zeeg [mm]	BC	Sit	u_{inst} [mm]	Toelaatbaar [mm]	
1	Dak	db	11350	Nee Nee	0.0	5	1	-31.9	-45.4	0.004

Project.....: 10745
 Onderdeel....: Liggers geschakeld dak zwakke richting
 Dimensies....: kN;m;rad (tenzij anders aangegeven)
 Bestand.....: N:\Order\10000\10700\10745\berekeningen en
 schetsen\Liggers geschakeld zwakke richting.rww

Belastingbreedte.: 1.000
 Rekenmodel.....: 2e-orde-elastisch.
 Theorieën voor de bepaling van de krachtsverdeling:
 1) Losse belastinggevallen:
 Lineaire-elasticiteitstheorie
 2) Uiterste grenstoestand:
 Geometrisch niet lineair alle staven.
 Fysisch lineair alle staven.
 3) Gebruiksgrenstoestand:
 Lineaire-elasticiteitstheorie

Maximum aantal iteraties.....: 50
 Max.deellengte kolommen/wanden: 0.500 Max.deellengte balken/vloeren: 0.500
 Max. X-verplaatsing in UGT.....: 0.500 Max. Z-verplaatsing in UGT...: 0.250

Gunstige werking van de permanente belasting wordt automatisch verwerkt.

Toegepaste normen volgens Eurocode met Nederlandse NB

Belastingen	NEN-EN 1990:2002	C2:2010,A1:2019	NB:2019(nl)
	NEN-EN 1991-1-1:2002	C1/C11:2019	NB:2019(nl)
	NEN-EN 1991-1-3:2003	A1:2019	NB:2019(nl)
Hout	NEN-EN 1995-1-1:2005	A2:2014,C1:2012	NB:2013(nl)
	NEN-EN 14080:2013		

GEOMETRIE

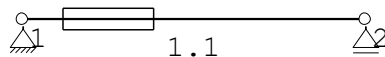

MATERIALEN

Mt	Kwaliteit	E-modulus[N/mm ²]	S.G.	S.G.verhoogd	Pois.	Uitz. coëff
1	GL28h	12600	4.2	5.1	1.00	5.0000e-06

Bij de bepaling v.h. e.g. van houten staven is de S.G.verhoogd toegepast.

PROFIELEN [mm]

Prof.	Omschrijving	Materiaal	Oppervlak	Traagheid	Vormf.
1	B*H 700*160	1:GL28h	1.1200e+05	2.3893e+08	0.00

PROFIELEN vervolg [mm]

Prof.	Staaftype	Breedte	Hoogte	e	Type	b1	h1	b2	h2
1	0:Normaal	700	160	80.0	0:RH				

Project.....: 10745
 Onderdeel....: Liggers geschakeld dak zwakke richting

PROFIELVORMEN [mm]

1 B*H 700*160



KNOPEN

Knoop	X	Z
1	0.000	0.000
2	4.000	0.000

STAVEN

St.	ki	kj	Profiel	Aansl.i	Aansl.j	Lengte	Opm.
1	1	2	1:B*H 700*160	NDM	NDM	4.000	

VASTE STEUNPUNTEN

Nr.	knoop	Kode	XZR	l=vast	0=vrij	Hoek
1	1	110				0.00
2	2	010				0.00

BELASTINGGEVALLEN

B.G.	Omschrijving	EGZ=0.00	Type
1	Permanente belasting		1
2	Sneeuw A		22

BELASTINGGEVALLEN vervolg

B.G.	Omschrijving	Belastingduurklasse
1	Permanente belasting	Blijvend
2	Sneeuw A	Kort

BELASTINGEN

B.G:1 Permanente belasting

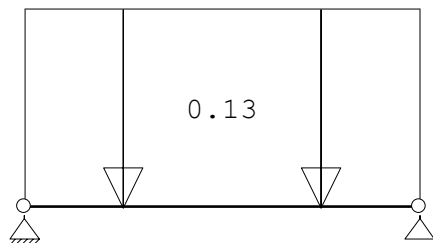

STAAFBELASTINGEN

B.G:1 Permanente belasting

Staaftype	Type	q1/p/m	q2	A	B	ψ_0	ψ_1	ψ_2
1	5:QZGlobaal	-0.13	-0.13	0.000	0.000			

Project.....: 10745
 Onderdeel....: Liggers geschakeld dak zwakke richting

BELASTINGEN

B.G:2 Sneeuw A

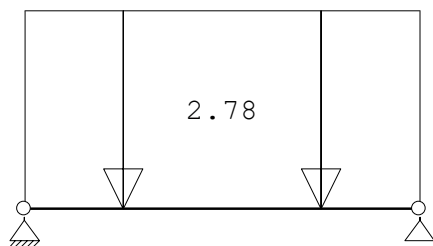

STAAFBELASTINGEN

B.G:2 Sneeuw A

Staat Type	q1/p/m	q2	A	B	Ψ ₀	Ψ ₁	Ψ ₂
1 3:QZgeProj.	-2.78	-2.78	0.000	0.000	0.00	0.20	0.00

REACTIES 1e orde

Kn.	B.G.	X	Z	M
1	1	0.00	0.26	
1	2	0.00	5.56	
2	1		0.26	
2	2		5.56	

BEREKENINGSTATUS

B.C.	Iteratie	Status
1	3	Nauwkeurigheid bereikt
2	3	Nauwkeurigheid bereikt
3	3	Nauwkeurigheid bereikt
4	3	Nauwkeurigheid bereikt
5	1	Lineaire berekening
6	1	Lineaire berekening
7	1	Lineaire berekening

BELASTINGCOMBINATIES

BC Type	BG	Gen.	Factor	BG	Gen.	Factor	BG	Gen.	Factor	BG	Gen.	Factor
1	Fund.	1	Perm	1.35								
2	Fund.	1	Perm	0.90								
3	Fund.	1	Perm	1.20	2	Extr	1.50					
4	Fund.	1	Perm	0.90	2	Extr	1.50					
5	Kar.	1	Perm	1.00	2	Extr	1.00					
6	Quas.	1	Perm	1.00								
7	Blij.	1	Perm	1.00								

GUNSTIGE WERKING PERMANENTE BELASTINGEN

BC	Staven met gunstige werking
1	Geen
2	Alle staven de factor:0.90
3	Geen
4	Alle staven de factor:0.90

Project.....: 10745
 Onderdeel....: Liggers geschakeld dak zwakke richting

OMHULLENDE VAN DE FUNDAMENTELE COMBINATIES

MOMENTEN 2e orde Fundamentele combinatie

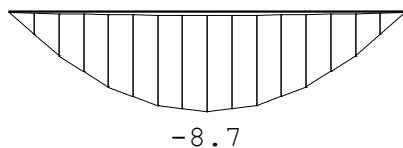

DWARSKRACHTEN 2e orde Fundamentele combinatie

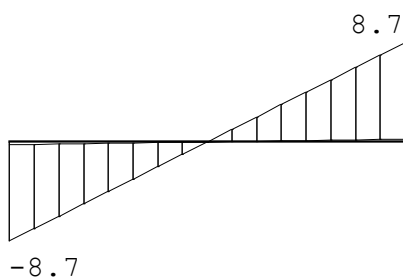

STAAFKRACHTEN 2e orde Fundamentele combinatie

St.	Kn.	Pos.	NXi/NXj			DZi/DZj			MYi/MYj					
			Min	BC	Max	BC	Min	BC	Max	BC	Min	BC	Max	BC
1	1		0.00	2	0.04	3	-8.65	3	-0.23	2	0.00	1	0.00	1
1	2.000		0.00	3	0.00	4	0.00	1	0.00	4	-8.65	3	-0.23	2
1	2		0.00	2	0.04	3	0.23	2	8.65	3	0.00	3	0.00	4

REACTIES 2e orde Fundamentele combinatie

Kn.	X-min	X-max	Z-min	Z-max	M-min	M-max
1	0.00	0.00	0.23	8.65		
2			0.23	8.65		

MATERIAALGEGEVENS

Mt	Kwaliteit	$f_{m,y,k}$ [N/mm ²]	ρ_k [kg/m ³]	ρ_{mean} [kg/m ³]	$f_{t,0,k}$ [N/mm ²]	$f_{t,90,k}$ [N/mm ²]	$f_{c,0,k}$ [N/mm ²]	$f_{c,90,k}$ [N/mm ²]	$f_{v,k}$ [N/mm ²]
1	GL28h	28	425	460	22.3	0.5	28.0	2.5	3.5

MATERIAALGEGEVENS (vervolg)

Mt	Kwaliteit	G_{mean} [N/mm ²]	$E_{0,05}$ [N/mm ²]	$E_{90,mean}$ [N/mm ²]	$E_{0,mean}$ [N/mm ²]	Klimaatklasse	k_{def}	$E_{0,mean,fin}$ [N/mm ²]
1	GL28h	650	10500	300	12600	I	0.60	7875

Project.....: 10745
 Onderdeel....: Liggers geschakeld dak zwakke richting

KIPSTABILITEIT

Staal	Plts. aangr.	l sys.	Kipsteunafstanden
		[m]	[m]
1	1.0*h	boven:	4.00 0.000;4.000
		onder:	4.00 0.000;4.000

STABILITEIT

Stf	b _{gem}	h _{gem}	l _{sys}	l _{buc, y/z}	λ _y	λ _z	λ _{rel, y/z}	β _c	k _y	k _z	k _{c, y}	k _{c, z}		
	[mm]	[mm]	[mm]	[mm]										
1	700	160	4000	4000	nvt	86.6	19.8	1.424	0.325	0.1	1.569	0.554	0.448	0.997

STABILITEIT (vervolg)

Staal	positie	l _{ef, y}	σ _{my, crit}	λ _{rel, my}	k _{crit, y}
	[mm]	[mm]	[N/mm ²]		
1	2000	3920	6398.44	0.07	1.00

TOETSING SPANNINGEN

Staal	1	BC / Sit.	3 / 1	UC frm(6.11)	0.13
-------	---	-----------	-------	--------------	------

TOETSING DOORBUIGING

Stf	Soort	Mtg	l _{sys}	Overstek	BC	Sit	u _{bij}	Toelaatbaar	u _{fin, net}	Toelaatbaar		
			[mm]	i j			[mm]	[mm] *1	[mm]	[mm] *1		
1	Dak	db	4000	Nee Nee	6	1	-3.2	-16.0	0.004	-3.3	-16.0	0.004

TOETSING DOORBUIGING (vervolg)

Stf	Soort	Mtg	l _{sys}	Overstek	Zeeg	BC	Sit	u _{inst}	Toelaatbaar	
			[mm]	i j	[mm]			[mm]	[mm] *1	
1	Dak	db	4000	Nee Nee	0.0	5	1	-3.2	-16.0	0.004

Toetsing

UC = 0.71 + 0.7*0.13 = 0.80

Controle oplegging as C

Oplegging op metselwerk oplegbreedte 160 mm opleglengte 200 mm F_d = 62.63 kN
 σ = 62.63*10³/(160*200) = 1.96 N/mm² < 2.50 N/mm²

2.3 Hoekkeper

lengte = 1.50 - 3.90 - 3.20 - 2.96985 m

steunpunt op 1.50, 5.40 en 11.56985 m

blijvend

q1	op 0.00 m		
dak_schuin		$0.75 * 0.00$	= 0.00 kN/m ¹
	op 1.50 m		
dak_schuin		$0.75 * 2.00 * 0.707$	= 1.06 kN/m ¹
q2	op 1.50 m		
dak_schuin		$0.75 * 0.00$	= 0.00 kN/m ¹
	op 5.40 m		
dak_schuin		$0.75 * 2.80 * 0.707$	= 1.48 kN/m ¹
q3	op 5.40 m		
dak_schuin		$0.75 * 0.00$	= 0.00 kN/m ¹
	op 8.60 m		
dak_schuin		$0.75 * 3.16 * 0.707$	= 1.68 kN/m ¹
q4	op 8.60 m		
dak_schuin		$0.75 * 0.00$	= 0.00 kN/m ¹
	op 11.57 m		
dak_schuin		$0.75 / 0.866 * 2.10 * 0.707$	= 1.29 kN/m ¹

sneeuw

q1	op 0.00 m		
sneeuw_aang_gem		$1.12 * 0.00$	= 0.00 kN/m ¹
	op 1.50 m		
sneeuw_aang_gem		$1.12 * 2.00 * 0.707$	= 1.58 kN/m ¹
q2	op 1.50 m		
sneeuw_aang_gem		$1.12 * 0.00$	= 0.00 kN/m ¹
	op 5.40 m		
sneeuw_aang_gem		$1.12 * 2.80 * 0.707$	= 2.22 kN/m ¹
q3	op 5.40 m		
sneeuw_aang_gem		$1.12 * 0.00$	= 0.00 kN/m ¹
	op 8.60 m		
sneeuw_aang_gem		$1.12 * 3.16 * 0.707$	= 2.50 kN/m ¹
q4	op 8.60 m		
sneeuw_aang_gem		$1.12 * 0.00$	= 0.00 kN/m ¹
	op 11.57 m		
sneeuw_aang_gem		$1.12 * 2.10 * 0.707$	= 1.66 kN/m ¹

<i>wind</i>			
stuwdruk_qp		$-0.94 * 1.3$	= - 1.22 kN/m ¹
stuwdruk_qp		$-0.94 * (0.7+0.3)$	= - 0.94 kN/m ¹
q1	op 0.00 m		
wind		$-1.22 * 0.00$	= 0.00 kN/m ¹
	op 1.50 m		
wind		$-1.22 * 2.00 * 0.707$	= - 1.73 kN/m ¹
q2	op 1.50 m		
wind		$-1.22 * 0.00$	= 0.00 kN/m ¹
	op 5.40 m		
wind		$-1.22 * 2.80 * 0.707$	= - 2.42 kN/m ¹
q3	op 5.40 m		
wind		$-0.94 * 0.00$	= 0.00 kN/m ¹
	op 8.60 m		
wind		$-0.94 * 3.16 * 0.707$	= - 2.10 kN/m ¹
q4	op 8.60 m		
wind		$-0.94 * 0.00$	= 0.00 kN/m ¹
	op 11.57 m		
wind		$-0.94 / 0.866 * 2.10 * 0.707$	= - 1.61 kN/m ¹

Project.....: 10745
 Onderdeel....: hoekkeper
 Dimensies....: kN;m;rad (tenzij anders aangegeven)
 Bestand.....: N:\Order\10000\10700\10745\berekeningen en
 schetsen\hoekkeper.rww

Belastingbreedte.: 1.000
 Rekenmodel.....: 2e-orde-elastisch.
 Theorieën voor de bepaling van de krachtsverdeling:

- 1) Losse belastinggevallen:
 Lineaire-elasticiteitstheorie
- 2) Uiterste grenstoestand:
 Geometrisch niet lineair alle staven.
 Fysisch lineair alle staven.
- 3) Gebruiksgrenstoestand:
 Lineaire-elasticiteitstheorie

Maximum aantal iteraties.....: 50
 Max.deellengte kolommen/wanden: 0.500 Max.deellengte balken/vloeren: 0.500
 Max. X-verplaatsing in UGT.....: 0.500 Max. Z-verplaatsing in UGT...: 0.250

Gunstige werking van de permanente belasting wordt automatisch verwerkt.

Toegepaste normen volgens Eurocode met Nederlandse NB

Belastingen	NEN-EN 1990:2002	C2:2010,A1:2019	NB:2019(nl)
	NEN-EN 1991-1-1:2002	C1/C11:2019	NB:2019(nl)
	NEN-EN 1991-1-3:2003	A1:2019	NB:2019(nl)
Hout	NEN-EN 1995-1-1:2005	A2:2014,C1:2012	NB:2013(nl)

GEOMETRIE

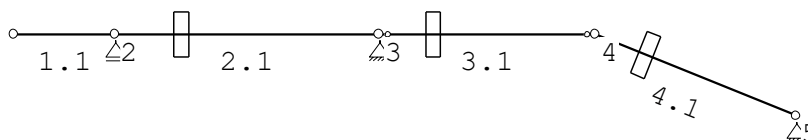

MATERIALEN

Mt	Kwaliteit	E-modulus [N/mm ²]	S.G.	S.G.verhoogd	Pois.	Uitz. coëff
1	C24	11000	3.5	4.2	1.00	5.0000e-06

Bij de bepaling v.h. e.g. van houten staven is de S.G.verhoogd toegepast.

PROFIELEN [mm]

Prof.	Omschrijving	Materiaal	Oppervlak	Traagheid	Vormf.
1	B*H 96*296	1:C24	2.8416e+04	2.0747e+08	0.00

PROFIELEN vervolg [mm]

Prof.	Staaftype	Breedte	Hoogte	e	Type	b1	h1	b2	h2
1	0:Normaal	96	296	148.0	0:RH				

Project.....: 10745
 Onderdeel....: hoekkeper

PROFIELVORMEN [mm]

1 B*H 96*296



KNOPEN

Knoop	X	Z
1	0.000	8.012
2	1.500	8.012
3	5.400	8.012
4	8.600	8.012
5	11.570	6.800

STAVEN

St.	ki	kj	Profiel	Aansl.i	Aansl.j	Lengte	Opm.
1	1	2	1:B*H 96*296	NDM	NDM	1.500	
2	2	3	1:B*H 96*296	NDM	NDM	3.900	
3	3	4	1:B*H 96*296	ND-	ND-	3.200	
4	4	5	1:B*H 96*296	NDM	NDM	3.208	

VASTE STEUNPUNTEN

Nr.	knoop	Kode	XZR	l=vast	0=vrij	Hoek
1	2	010				0.00
2	3	110				0.00
3	5	110				0.00

BELASTINGGEVALLEN

B.G.	Omschrijving	EGZ	Type
1	Permanente belasting	EGZ=-1.00	1
2	Sneeuw A		22
3	Sneeuw B		23
4	Sneeuw C		33

BELASTINGGEVALLEN vervolg

B.G.	Omschrijving	Belastingduurklasse
1	Permanente belasting	Blijvend
2	Sneeuw A	Kort
3	Sneeuw B	Kort
4	Sneeuw C	Kort

Project.....: 10745
 Onderdeel....: hoekkeper

BELASTINGEN

B.G:1 Permanente belasting

Eigen gewicht van alle staven is meegenomen in berekening. Richting:↓

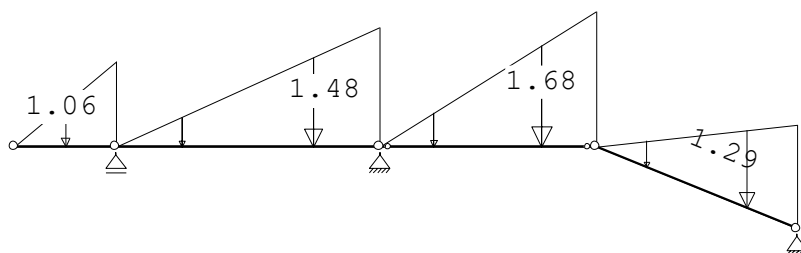

STAAFBELASTINGEN

B.G:1 Permanente belasting

Staatf Type	q1/p/m	q2	A	B	Ψ_0	Ψ_1	Ψ_2
1 5:QZGloaal	0.00	-1.06	0.000	0.000			
2 5:QZGloaal	0.00	-1.48	0.000	0.000			
3 5:QZGloaal	0.00	-1.68	0.000	0.000			
4 5:QZGloaal	0.00	-1.29	0.000	0.000			

BELASTINGEN

B.G:2 Sneeuw A

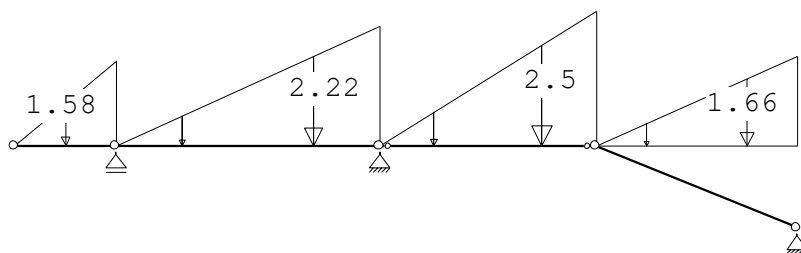

STAAFBELASTINGEN

B.G:2 Sneeuw A

Staatf Type	q1/p/m	q2	A	B	Ψ_0	Ψ_1	Ψ_2
1 3:QZgeProj.	-0.00	-1.58	0.000	0.000	0.00	0.20	0.00
2 3:QZgeProj.	0.00	-2.22	0.000	0.000	0.00	0.20	0.00
3 3:QZgeProj.	0.00	-2.50	0.000	0.000	0.00	0.20	0.00
4 3:QZgeProj.	0.00	-1.66	0.000	0.000	0.00	0.20	0.00

BELASTINGEN

B.G:3 Sneeuw B

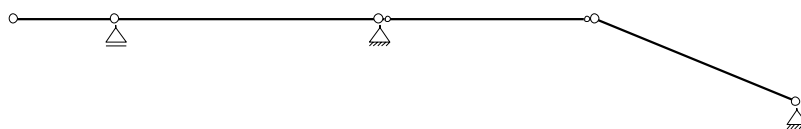

Project.....: 10745
 Onderdeel....: hoekkeper

BELASTINGEN

B.G:4 Sneeuw C

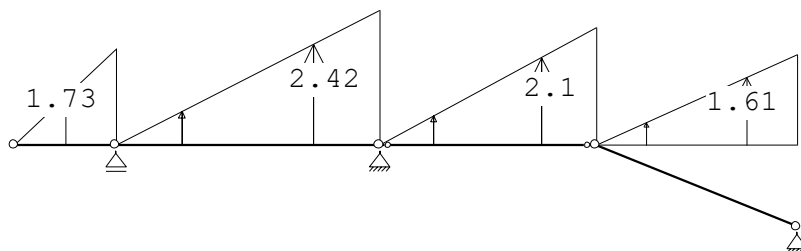

STAAFBELASTINGEN

B.G:4 Sneeuw C

Staaf	Type	q1/p/m	q2	A	B	Ψ_0	Ψ_1	Ψ_2
1	3:QZgeProj.	0.00	1.73	0.000	0.000	0.00	0.20	0.00
2	3:QZgeProj.	0.00	2.42	0.000	0.000	0.00	0.20	0.00
3	3:QZgeProj.	0.00	2.10	0.000	0.000	0.00	0.20	0.00
4	3:QZgeProj.	0.00	1.61	0.000	0.000	0.00	0.20	0.00

REACTIES 1e orde

Kn.	B.G.	X	Z	M
2	1		2.31	
2	2		2.78	
2	3		0.00	
2	4		-3.04	
3	1	7.02	3.11	
3	2	8.54	4.07	
3	3	0.00	0.00	
3	4	-7.44	-4.10	
5	1	-7.02	4.43	
5	2	-8.54	5.13	
5	3	0.00	0.00	
5	4	7.44	-4.63	

BEREKENINGSTATUS

B.C.	Iteratie	Status
1	3	Nauwkeurigheid bereikt
2	3	Nauwkeurigheid bereikt
3	3	Nauwkeurigheid bereikt
4	3	Nauwkeurigheid bereikt
5	3	Nauwkeurigheid bereikt
6	3	Nauwkeurigheid bereikt
7	1	Lineaire berekening
8	1	Lineaire berekening
9	1	Lineaire berekening
10	1	Lineaire berekening
11	1	Lineaire berekening
12	1	Lineaire berekening
13	1	Lineaire berekening

Project.....: 10745
 Onderdeel....: hoekkeper

DWARSKRACHTEN 2e orde Fundamentele combinatie

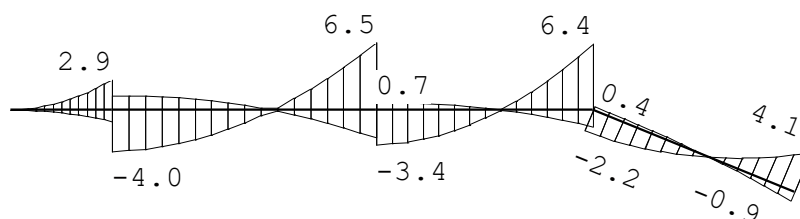

NORMAALKRACHTEN 2e orde Fundamentele combinatie

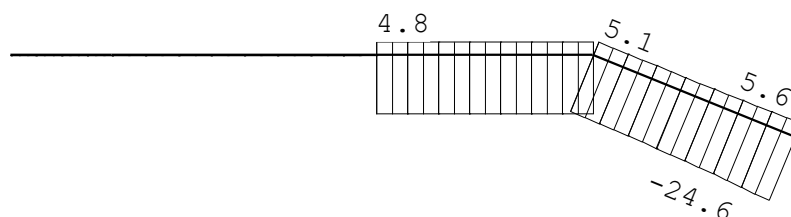

STAAFKRACHTEN 2e orde Fundamentele combinatie

St.	Kn.	Pos.	NXi/NXj			DZi/DZj			MYi/MYj					
			Min	BC	Max	Min	BC	Max	Min	BC	Max	BC		
1	1		0.00	1	0.00	1	0.00	1	0.00	1	0.00	1		
1	2		-0.01	3	-0.00	2	-1.07	6	2.95	3	-0.49	6	1.53	3
2	2		0.00	4	0.01	3	-3.99	3	1.41	6	-0.49	6	1.53	3
2		0.244	0.00	2	0.01	3	-3.88	3	1.40	6	-0.15	6	0.58	3
2		0.488	0.00	2	0.01	3	-3.76	3	1.39	6	-0.38	3	0.19	6
2		2.194	-0.00	4	0.00	3	-0.49	3	0.21	6	-4.49	3	1.79	6
2		2.438	0.00	4	0.00	3	-0.08	6	0.25	3	-4.61	3	1.84	6
2	3		0.00	2	0.02	3	-2.65	6	6.53	3	0.00	2	0.00	3
3	3		-21.28	3	4.84	6	-3.35	3	0.70	6	0.00	1	0.00	1
3		1.829	-21.29	3	4.84	6	-0.03	5	0.05	4	-4.02	3	0.94	6
3		1.829	-21.29	3	4.84	6	-0.02	5	0.05	4	-4.02	3	0.94	6
3	4		-21.28	3	4.84	6	-1.57	6	6.43	3	0.00	5	0.00	4
4	4		-22.12	3	5.08	6	-2.15	3	0.37	6	0.00	1	0.00	1
4		0.458	-22.20	3	5.07	6	-1.97	3	0.38	6	-0.95	3	0.18	6
4		1.833	-22.99	3	5.22	6	-0.01	5	0.04	4	-2.56	3	0.53	6
4		1.833	-22.99	3	5.22	6	-0.00	5	0.04	4	-2.56	3	0.53	6
4	5		-24.63	3	5.60	6	-0.90	6	4.07	3	0.00	5	0.00	3

REACTIES 2e orde Fundamentele combinatie

Kn.	X-min	X-max	Z-min	Z-max	M-min	M-max
2			-2.48	6.94		
3	-4.84	21.29	-3.35	9.82		
5	-21.29	4.84	-2.95	13.03		

Project.....: 10745
 Onderdeel....: hoekkeper

MATERIAALGEGEVENS

Mt	Kwaliteit	$f_{m,y,k}$ [N/mm ²]	ρ_k [kg/m ³]	ρ_{mean} [kg/m ³]	$f_{t,0,k}$ [N/mm ²]	$f_{t,90,k}$ [N/mm ²]	$f_{c,0,k}$ [N/mm ²]	$f_{c,90,k}$ [N/mm ²]	$f_{v,k}$ [N/mm ²]
1	C24	24	350	420	14.5	0.4	21.0	2.5	4.0

MATERIAALGEGEVENS (vervolg)

Mt	Kwaliteit	G_{mean} [N/mm ²]	$E_{0,05}$ [N/mm ²]	$E_{90,mean}$ [N/mm ²]	$E_{0,mean}$ [N/mm ²]	Klimaatklasse	k_{def}	$E_{0,mean,fin}$ [N/mm ²]
1	C24	690	7400	370	11000	II	0.80	6111

KIPSTABILITEIT

StAAF	Plts. aangr.	l sys. [m]	Kipsteunafstanden [m]
1	1.0*h	boven: onder:	1.50 0;1.500 1.50 0;1.500
2	1.0*h	boven: onder:	3.90 3*1.3 3.90 1*3.9
3	1.0*h	boven: onder:	3.20 3*1.067 3.20 1*3.2
4	1.0*h	boven: onder:	3.21 0;3.208 3.21 0;3.208

STABILITEIT

Stf	b_{gem} [mm]	h_{gem} [mm]	l_{sys} [mm]	$l_{buc,y/z}$ [mm]	λ_y	λ_z	$\lambda_{rel,y/z}$	β_c	k_y	k_z	$k_{c,y}$	$k_{c,z}$
1	96	296	1500	nvt 1500	17.6	54.1	0.298 0.918	0.2	0.544	0.983	1.001	0.749
2	96	296	3900	nvt 3900	45.6	140.7	0.774 2.386	0.2	0.847	3.556	0.840	0.161
3	96	296	3200	nvt 3200	37.4	115.5	0.635 1.958	0.2	0.735	2.583	0.905	0.234
4	96	296	3208	nvt 3208	37.5	115.8	0.637 1.963	0.2	0.736	2.593	0.904	0.233

STABILITEIT (vervolg)

StAAF	positie [mm]	$l_{ef,y}$ [mm]	$\sigma_{my,crit}$ [N/mm ²]	$\lambda_{rel,my}$	$k_{crit,y}$
1	1500	1202	149.51	0.40	1.00
2	2437	1892	94.99	0.50	1.00
3	1828	1659	108.33	0.47	1.00
4	1833	3800	47.29	0.71	1.00

TOETSING SPANNINGEN

StAAF	1	BC / Sit.	3 / 1	UC frm(6.19)	0.07

Project.....: 10745
 Onderdeel....: hoekkeper

TOETSING SPANNINGEN

Staafl	2	BC / Sit.	3 / 1	UC frm(6.17)	0.20
Staafl	3	BC / Sit.	3 / 1	UC frm(6.24)	0.34
Staafl	4	BC / Sit.	3 / 1	UC frm(6.24)	0.32

TOETSING DOORBUIGING

Stf	Soort	Mtg	l_{sys} [mm]	Overstek i j	BC Sit	u_{bij} [mm]	Toelaatbaar [mm]	$u_{fin,net}$ [mm]	Toelaatbaar [mm]
1	Dak	ss	1500	Nee Nee	9 1	-1.7	-12.0	-2.4	-12.0
2	Dak	db	3900	Nee Nee	9 1	-1.9	-15.6	-2.9	-15.6
3	Dak	db	3200	Nee Nee	9 1	-1.2	-12.8	-1.8	-12.8
4	Dak	db	3208	Nee Nee	9 1	-0.8	-12.8	-1.2	-12.8

TOETSING DOORBUIGING (vervolg)

Stf	Soort	Mtg	l_{sys} [mm]	Overstek i j	Zeeg [mm]	BC Sit	u_{inst} [mm]	Toelaatbaar [mm]
1	Dak	ss	1500	Nee Nee	0.0	7 1	-1.8	-12.0
2	Dak	db	3900	Nee Nee	0.0	7 1	-2.1	-15.6
3	Dak	db	3200	Nee Nee	0.0	7 1	-1.3	-12.8
4	Dak	db	3208	Nee Nee	0.0	7 1	-0.8	-12.8

2.4 Spoor in overstek

lengte = 2.20 - 2.20 m
 steunpunt op 2.20 en 4.20 m

belasting

dak_schuin	0.75 * 0.60	= 0.45 kN/m ¹
stuwdruk_qp_buiten	0.94 * 1.30 * 0.60	= 0.73 kN/m ¹
stuwdruk_qp_binnen	0.94 * (0.7+0.3) * 0.60	= 0.56 kN/m ¹
sneeuw_aang_gem	1.12 * 0.60	= 0.67 kN/m ¹
extreem	2.00 * 0.5	= 1.00 kN

Technosoft Raamwerken release 6.84b

20 nov 2025

Project.....: 10745
 Onderdeel....: Spoor in overstek
 Dimensies....: kN;m;rad (tenzij anders aangegeven)
 Bestand.....: N:\Order\10000\10700\10745\berekeningen en schetsen\Spoor
 in overstek.rww

Belastingbreedte.: 1.000
 Rekenmodel.....: 2e-orde-elastisch.
 Theorieën voor de bepaling van de krachtsverdeling:
 1) Losse belastinggevallen:
 Lineaire-elasticiteitstheorie
 2) Uiterste grenstoestand:
 Geometrisch niet lineair alle staven.
 Fysisch lineair alle staven.
 3) Gebruiksgrenstoestand:
 Lineaire-elasticiteitstheorie

Maximum aantal iteraties.....: 50
 Max.deellengte kolommen/wanden: 0.500 Max.deellengte balken/vloeren: 0.500
 Max. X-verplaatsing in UGT.....: 0.500 Max. Z-verplaatsing in UGT....: 0.250

Gunstige werking van de permanente belasting wordt automatisch verwerkt.

Toegepaste normen volgens Eurocode met Nederlandse NB

Belastingen	NEN-EN 1990:2002	C2:2010,A1:2019	NB:2019(nl)
	NEN-EN 1991-1-1:2002	C1/C11:2019	NB:2019(nl)
	NEN-EN 1991-1-3:2003	A1:2019	NB:2019(nl)
	NEN-EN 1991-1-4:2005	C2:2023	NB:2019(nl)
Hout	NEN-EN 1995-1-1:2005	A2:2014,C1:2012	NB:2013(nl)

GEOMETRIE

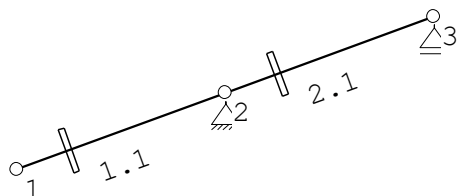

MATERIALEN

Mt	Kwaliteit	E-modulus [N/mm ²]	S.G.	S.G.verhoogd	Pois.	Uitz. coëff
1	C24	11000	3.5	4.2	1.00	5.0000e-06

Bij de bepaling v.h. e.g. van houten staven is de S.G.verhoogd toegepast.

PROFIELEN [mm]

Prof.	Omschrijving	Materiaal	Oppervlak	Traagheid	Vormf.
1	B*H 38*286	1:C24	1.0868e+04	7.4080e+07	0.00

Project.....: 10745
 Onderdeel....: Spoor in overstek

PROFIELEN vervolg [mm]

Prof.	Staaftype	Breedte	Hoogte	e	Type	b1	h1	b2	h2
1	0:Normaal	38	286	143.0	0:RH				

PROFIELVORMEN [mm]

1 B*H 38*286



KNOPEN

Knoop	X	Z
1	0.000	6.000
2	2.200	6.801
3	4.400	7.601

STAVEN

St.	ki	kj	Profiel	Aansl.i	Aansl.j	Lengte	Opm.
1	1	2	1:B*H 38*286	NDM	NDM	2.341	
2	2	3	1:B*H 38*286	NDM	NDM	2.341	

VASTE STEUNPUNTEN

Nr.	knoop	Kode	XZR	1=vast	0=vrij	Hoek
1	2	110				0.00
2	3	010				0.00

BELASTINGGEVALLEN

B.G.	Omschrijving	EGZ	Type
1	Permanente belasting	EGZ=0.00	1
2	Wind van links onderdruk A		7
3	Wind van links overdruk A		8
4	Wind van links onderdruk B		9
5	Wind van links overdruk B		10
6	Sneeuw A		22

BELASTINGGEVALLEN vervolg

B.G.	Omschrijving	Belastingduurklasse
1	Permanente belasting	Blijvend
2	Wind van links onderdruk A	Kort
3	Wind van links overdruk A	Kort
4	Wind van links onderdruk B	Kort
5	Wind van links overdruk B	Kort
6	Sneeuw A	Kort

Project.....: 10745
 Onderdeel....: Spoor in overstek

BELASTINGEN

B.G:1 Permanente belasting

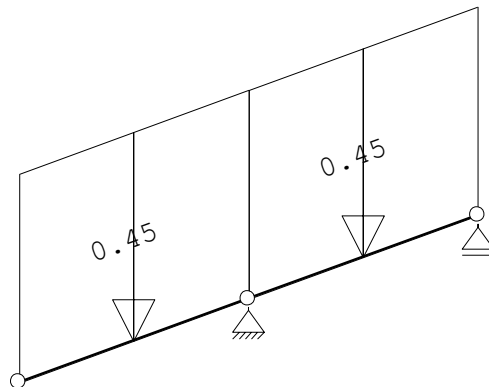

STAAFBELASTINGEN

B.G:1 Permanente belasting

StAAF	Type	q1/p/m	q2	A	B	Ψ_0	Ψ_1	Ψ_2
1	5:QZGloaal	-0.45	-0.45	0.000	0.000			
2	5:QZGloaal	-0.45	-0.45	0.000	0.000			

BELASTINGEN

B.G:2 Wind van links onderdruk A

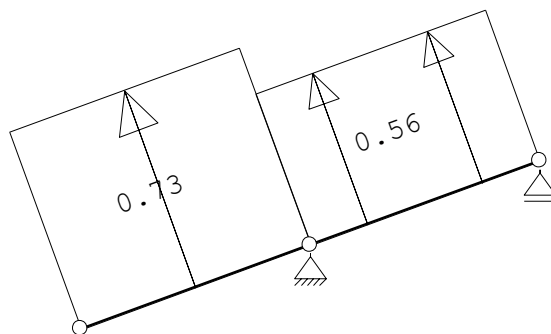

STAAFBELASTINGEN

B.G:2 Wind van links onderdruk A

StAAF	Type	q1/p/m	q2	A	B	Ψ_0	Ψ_1	Ψ_2
1	1:QZLokaal	0.73	0.73	0.000	0.000	0.00	0.00	0.00
2	1:QZLokaal	0.56	0.56	0.000	0.000	0.00	0.00	0.00

Project.....: 10745
 Onderdeel....: Spoor in overstek

BELASTINGEN

B.G:3 Wind van links overdruk A

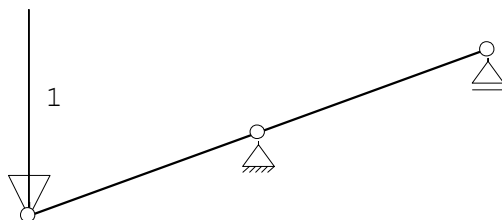

STAAFBELASTINGEN

B.G:3 Wind van links overdruk A

StAAF Type	q1/p/m	q2	A	B	Ψ_0	Ψ_1	Ψ_2
1 10:PZGepro.j.	-1.00		0.000		0.00	0.20	0.00

BELASTINGEN

B.G:4 Wind van links onderdruk B

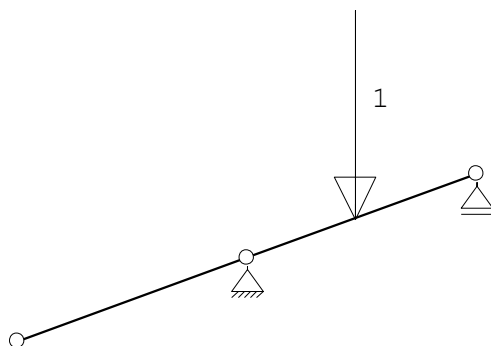

STAAFBELASTINGEN

B.G:4 Wind van links onderdruk B

StAAF Type	q1/p/m	q2	A	B	Ψ_0	Ψ_1	Ψ_2
2 10:PZGepro.j.	-1.00		1.100		0.00	0.20	0.00

BELASTINGEN

B.G:5 Wind van links overdruk B

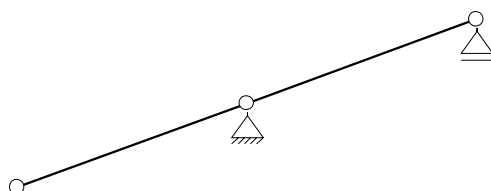

Project.....: 10745
 Onderdeel....: Spoor in overstek

BELASTINGEN

B.G:6 Sneeuw A

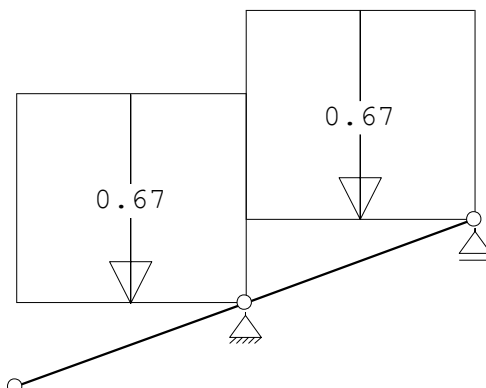

STAAFBELASTINGEN

B.G:6 Sneeuw A

Staaftype	Type	q1/p/m	q2	A	B	ψ_0	ψ_1	ψ_2
1	3:QZgeProj.	-0.67	-0.67	0.000	0.000	0.00	0.20	0.00
2	3:QZgeProj.	-0.67	-0.67	0.000	0.000	0.00	0.20	0.00

REACTIES

1e orde

Kn.	B.G.	X	Z	M
2	1	0.00	2.11	
2	2	1.03	-3.05	
2	3	0.00	2.00	
2	4	0.00	0.53	
2	5	0.00	0.00	
2	6	0.00	2.95	
3	1		0.00	
3	2		0.21	
3	3		-1.00	
3	4		0.47	
3	5		0.00	
3	6		0.00	

BEREKENINGSTATUS

B.C.	Iteratie	Status
1	3	Nauwkeurigheid bereikt
2	3	Nauwkeurigheid bereikt
3	3	Nauwkeurigheid bereikt
4	3	Nauwkeurigheid bereikt
5	3	Nauwkeurigheid bereikt
6	3	Nauwkeurigheid bereikt
7	3	Nauwkeurigheid bereikt
8	3	Nauwkeurigheid bereikt
9	3	Nauwkeurigheid bereikt
10	2	Nauwkeurigheid bereikt
11	3	Nauwkeurigheid bereikt
12	3	Nauwkeurigheid bereikt

Project.....: 10745
Onderdeel....: Spoor in overstek

BEREKENINGSTATUS

B.C.	Iteratie	Status
13	1	Lineaire berekening
14	1	Lineaire berekening
15	1	Lineaire berekening
16	1	Lineaire berekening
17	1	Lineaire berekening
18	1	Lineaire berekening
19	1	Lineaire berekening
20	1	Lineaire berekening
21	1	Lineaire berekening
22	1	Lineaire berekening
23	1	Lineaire berekening
24	1	Lineaire berekening

BELASTINGCOMBINATIES

BC Type	BG Gen.	Factor	BG Gen.	Factor	BG Gen.	Factor	BG Gen.	Factor
1 Fund.	1 Perm	1.35						
2 Fund.	1 Perm	0.90						
3 Fund.	1 Perm	1.20	2 Extr	1.50				
4 Fund.	1 Perm	1.20	3 Extr	1.50				
5 Fund.	1 Perm	1.20	4 Extr	1.50				
6 Fund.	1 Perm	1.20	5 Extr	1.50				
7 Fund.	1 Perm	1.20	6 Extr	1.50				
8 Fund.	1 Perm	0.90	2 Extr	1.50				
9 Fund.	1 Perm	0.90	3 Extr	1.50				
10 Fund.	1 Perm	0.90	4 Extr	1.50				
11 Fund.	1 Perm	0.90	5 Extr	1.50				
12 Fund.	1 Perm	0.90	6 Extr	1.50				
13 Kar.	1 Perm	1.00	2 Extr	1.00				
14 Kar.	1 Perm	1.00	3 Extr	1.00				
15 Kar.	1 Perm	1.00	4 Extr	1.00				
16 Kar.	1 Perm	1.00	5 Extr	1.00				
17 Kar.	1 Perm	1.00	6 Extr	1.00				
18 Quas.	1 Perm	1.00						
19 Freq.	1 Perm	1.00						
20 Freq.	1 Perm	1.00	3 psil	1.00				
21 Freq.	1 Perm	1.00	4 psil	1.00				
22 Freq.	1 Perm	1.00	5 psil	1.00				
23 Freq.	1 Perm	1.00	6 psil	1.00				
24 Blij.	1 Perm	1.00						

GUNSTIGE WERKING PERMANENTE BELASTINGEN

BC Staven met gunstige werking
1 Geen
2 Alle staven de factor:0.90
3 Geen
4 Geen
5 Geen
6 Geen
7 Geen
8 Alle staven de factor:0.90
9 Alle staven de factor:0.90
10 Alle staven de factor:0.90
11 Alle staven de factor:0.90
12 Alle staven de factor:0.90

Project.....: 10745
 Onderdeel....: Spoor in overstek

REACTIES		2e orde			Fundamentele combinatie	
Kn.	X-min	X-max	Z-min	Z-max	M-min	M-max
2	0.00	1.54	-2.68	6.95		
3			-1.49	0.71		

MATERIAALGEGEVENS

Mt	Kwaliteit	$f_{m,y,k}$ [N/mm ²]	ρ_k [kg/m ³]	ρ_{mean} [kg/m ³]	$f_{t,0,k}$ [N/mm ²]	$f_{t,90,k}$ [N/mm ²]	$f_{c,0,k}$ [N/mm ²]	$f_{c,90,k}$ [N/mm ²]	$f_{v,k}$ [N/mm ²]
1	C24	24	350	420	14.5	0.4	21.0	2.5	4.0

MATERIAALGEGEVENS (vervolg)

Mt	Kwaliteit	G_{mean} [N/mm ²]	$E_{0,05}$ [N/mm ²]	$E_{90,mean}$ [N/mm ²]	$E_{0,mean}$ [N/mm ²]	Klimaatklasse	k_{def}	$E_{0,mean,fin}$ [N/mm ²]
1	C24	690	7400	370	11000	I	0.60	6875

KIPSTABILITEIT

Staad	Plts. aangr.	l sys.	Kipsteunafstanden [m]
1	1.0*h	boven:	2.34 0;2*1.171
		onder:	2.34 0;2*1.171
2	1.0*h	boven:	2.34 2*1.171
		onder:	2.34 2*1.171

STABILITEIT

Stf	b_{gem} [mm]	h_{gem} [mm]	l_{sys} [mm]	$l_{buc,y/z}$ [mm]	λ_y	λ_z	$\lambda_{rel,y/z}$	β_c	k_y	k_z	$k_{c,y}$	$k_{c,z}$
1	38	286	2341	nvt	500	28.4	45.6	0.481	0.773	0.2	0.634	0.846
2	38	286	2341	nvt	500	28.4	45.6	0.481	0.773	0.2	0.634	0.846

STABILITEIT (vervolg)

Staad	positie [mm]	$l_{ef,y}$ [mm]	$\sigma_{my,crit}$ [N/mm ²]	$\lambda_{rel,my}$	$k_{crit,y}$
1	2341	1027	28.38	0.92	0.87
2	0	1028	28.35	0.92	0.87

TOETSING SPANNINGEN

Staad	1	BC / Sit.	4 / 1	UC frm(6.33)	0.62
Staad	2	BC / Sit.	4 / 1	UC frm(6.33)	0.62

TOETSING DOORBUIGING

Stf	Soort	Mtg	l_{sys} [mm]	Overstek i j	BC Sit	u_{bij} [mm]	Toelaatbaar [mm]	$u_{fin,net}$ *1 [mm]	Toelaatbaar [mm]	*1	
1	Dak	ss	2341	Nee Nee	18 1	-12.2	-18.7	2*0.004	-16.1	-18.7	2*0.004
2	Dak	db	2341	Nee Nee	18 1	1.1	9.4	0.004	1.4	9.4	0.004

TOETSING DOORBUIGING (vervolg)

Stf	Soort	Mtg	l_{sys} [mm]	Overstek i j	Zeeg [mm]	BC Sit	u_{inst} [mm]	Toelaatbaar [mm]	*1
1	Dak	ss	2341	Nee Nee	0.0	14 1	-13.8	-18.7	2*0.004
2	Dak	db	2341	Nee Nee	0.0	14 1	1.2	9.4	0.004

3 STAALCONSTRUCTIE

3.1 Dakniveau

3.1.1 Randligger as 1 en A

Maximale overspanning 5.625 m

<i>belasting</i>	uit knoop 1 paragraaf 2.1 Doorsnede schakeldak		
e.g. z	4.52	=	4.52 kN/m ¹
v.b. z	1.07	=	1.07 kN/m ¹
q _{Ed} z	7.02	=	7.02 kN/m ¹
e.g. x	1.44	=	1.44 kN/m ¹
v.b. x	0.85	=	0.85 kN/m ¹
q _{Ed} x	3.00	=	3.00 kN/m ¹

$$M_{Ed\ x} = 1/8 * 3.00 * 5.625^2 = 11.9\text{ kNm}$$

$$V_{Ed\ x} = 0.5 * 3.00 * 5.625 = 8.4\text{ kN}$$

Technosoft Raamwerken release 6.84b

14 nov 2025

Project.....: 10745
Onderdeel....: Randligger dak as 1 en A
Dimensies....: kN;m;rad (tenzij anders aangegeven)
Bestand.....: N:\Order\10000\10700\10745\berekeningen en schetsen\Randligger dak.rww

Belastingbreedte.: 1.000
Rekenmodel.....: 1e-orde-elastisch.
Theorie voor de bepaling van de krachtsverdeling:
Geometrisch lineair.
Fysisch lineair.

Gunstige werking van de permanente belasting wordt automatisch verwerkt.

Toegepaste normen volgens Eurocode met Nederlandse NB

Belastingen	NEN-EN 1990:2002	C2:2010,A1:2019	NB:2019(nl)
	NEN-EN 1991-1-1:2002	C1/C11:2019	NB:2019(nl)
	NEN-EN 1991-1-3:2003	A1:2019	NB:2019(nl)
Staal	NEN-EN 1993-1-1:2006	C2:2011,A1:2016	NB:2016(nl)

GEOMETRIE

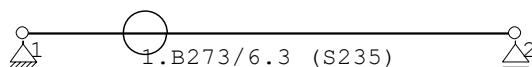

MATERIALEN

Mt	Kwaliteit	E-modulus [N/mm ²]	S.G.	Pois.	Uitz. coëff
1	S235	210000	78.5	0.30	1.2000e-05

PROFIELEN [mm]

Prof.	Omschrijving	Materiaal	Oppervlak	Traagheid	Vormf.
1	B273/6.3	1:S235	5.2785e+03	4.6958e+07	0.00

PROFIELEN vervolg [mm]

Prof.	Staaftype	Breedte	Hoogte	e	Type	b1	h1	b2	h2
1	0:Normaal	273	273	136.5					

PROFIELVORMEN [mm]

1 B273/6.3

Project.....: 10745
 Onderdeel....: Randligger dak as 1 en A

KNOPEN

Knoop	X	Z
1	0.000	0.000
2	5.625	0.000

STAVEN

St.	ki	kj	Profiel	Aansl.i	Aansl.j	Lengte	Opm.
1	1	2	1:B273/6.3	NDM	NDM	5.625	

VASTE STEUNPUNTEN

Nr.	knoop	Kode	XZR	l=vast	0=vrij	Hoek
1	1	110				0.00
2	2	010				0.00

BELASTINGGEVALLEN

B.G.	Omschrijving	EGZ	Type
1	Permanente belasting	EGZ=-1.00	1
2	Sneeuw A		22

BELASTINGEN

B.G:1 Permanente belasting

Eigen gewicht van alle staven is meegenomen in berekening. Richting:↓

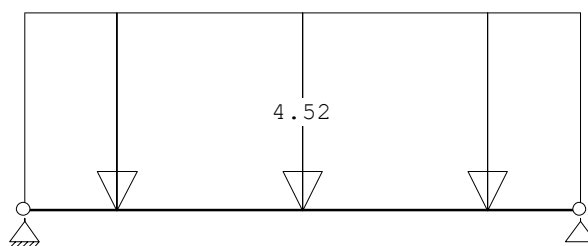

STAAFBELASTINGEN

B.G:1 Permanente belasting

StAAF	Type	q1/p/m	q2	A	B	ψ ₀	ψ ₁	ψ ₂
1	5:QZGlobaal	-4.52	-4.52	0.000	0.000			

BELASTINGEN

B.G:2 Sneeuw A

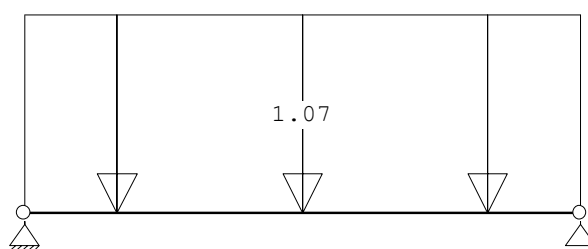

STAAFBELASTINGEN

B.G:2 Sneeuw A

StAAF	Type	q1/p/m	q2	A	B	ψ ₀	ψ ₁	ψ ₂
1	3:QZgeProj.	-1.07	-1.07	0.000	0.000	0.00	0.20	0.00

REACTIES

Kn.	B.G.	X	Z	M
1	1	0.00	13.88	
1	2	0.00	3.01	
2	1		13.88	
2	2		3.01	

Project.....: 10745
 Onderdeel....: Randligger dak as 1 en A

BELASTINGCOMBINATIES

BC Type	BG Gen.	Factor	BG Gen.	Factor	BG Gen.	Factor	BG Gen.	Factor
1 Fund.	1 Perm	1.35						
2 Fund.	1 Perm	0.90						
3 Fund.	1 Perm	1.20	2 Extr	1.50				
4 Fund.	1 Perm	0.90	2 Extr	1.50				
5 Kar.	1 Perm	1.00	2 Extr	1.00				
6 Quas.	1 Perm	1.00						
7 Freq.	1 Perm	1.00						
8 Freq.	1 Perm	1.00	2 psil	1.00				
9 Blij.	1 Perm	1.00						

GUNSTIGE WERKING PERMANENTE BELASTINGEN

BC Staven met gunstige werking
1 Geen
2 Alle staven de factor:0.90
3 Geen
4 Alle staven de factor:0.90

OMHULLENDE VAN DE FUNDAMENTELE COMBINATIES

MOMENTEN

Fundamentele combinatie

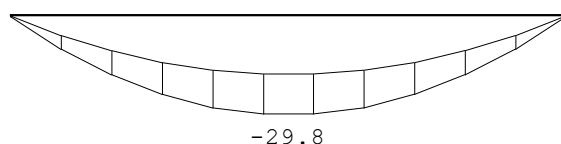

DWARSKRACHTEN

Fundamentele combinatie

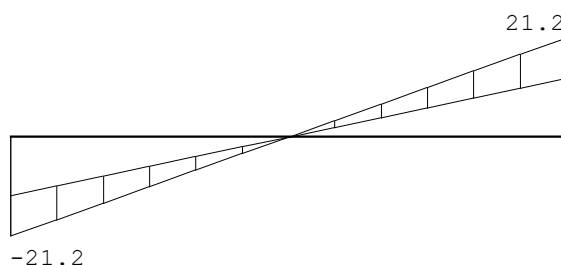

STAAFKRACHTEN

Fundamentele combinatie

St.	Kn.	Pos.	NXi/NXj		DZi/DZj				MYi/MYj					
			Min BC	Max BC	Min BC	Max BC	Min BC	Max BC	Min BC	Max BC				
1	1		0.00	1	0.00	1	-21.17	3	-12.49	2	0.00	3	0.00	2
	1	2.812	0.00	1	0.00	1	-0.00	3	0.00	2	-29.77	3	-17.56	2
	1	2	0.00	1	0.00	1	12.49	2	21.17	3	-0.00	3	0.00	2

REACTIES

Fundamentele combinatie

Kn.	X-min	X-max	Z-min	Z-max	M-min	M-max
1	0.00	0.00	12.49	21.17		

Project.....: 10745
 Onderdeel....: Randligger dak as 1 en A

REACTIES

Kn.	Fundamentele combinatie					
	X-min	X-max	Z-min	Z-max	M-min	M-max
2			12.49	21.17		

STAALPROFIELEN - ALGEMENE GEGEVENS

Stabiliteit: Classificatie gehele constructie: Geschoord

PROFIEL/MATERIAAL

P/M nr.	Profielnaam	Vloei- sp. [N/mm ²]	Productie methode	Min. drsn. klasse
1	B273/6.3	235	Warmgewalst	1

Partiële veiligheidsfactoren:
 Gamma M;0 : 1.00 Gamma M;1 : 1.00

KNIKSTABILITEIT

Staafl	l _{sys} [m]	Classif. y sterke as	Extra		Extra	
			l _{knik;y} [m]	aanp. y [kN]	Classif. z zwakke as	l _{knik;z} [m]
1	5.625	Geschoord	5.625	0.0	Geschoord	5.625 0.0

KIPSTABILITEIT

Staafl	Plts. aangr.	1 gaffel		Kipsteunafstanden	
		l _g [m]	l _o [m]	l _g [m]	l _o [m]
1	1.0*h	boven:	5.62	5.625	5.625
		onder:	5.625		

KRACHTEN UIT HET VLAK

Staafl	Mbegin [kNm]	Mmidden [kNm]	Meinde [kNm]	Vbegin [kN]	Vtpv [kN]	Mmax [kN]	Veinde [kN]	Mx [kNm]
1	0.0	11.9	0.0	8.4	0.0	8.4	0.0	

TOETSING SPANNINGEN

Staafl	P/M nr.	BC	Sit	Kl	Plaats	Norm	Artikel	Formule	Hoogste toetsing U.C. [N/mm ²]	Opm.
1	1	3	1	1	Staafl	EN3-1-1	6.3.3	(6.61)	0.333	78

TOETSING DOORBUIGING

Staafl	Soort	Mtg	Lengte [m]	Overst I J	Zeeg [mm]	u _{tot} [mm]	BC	Sit	u [mm]	Toelaatbaar [mm]	*1
1	Vlr+w	db	5.62	N N	0.0	-7.9	5	1 Eind	-7.9	±22.5	0.004
		db					5	1 Bijk	-1.4	±11.3	0.002

3.1.2 Drukkoker schakeldak

Reactie

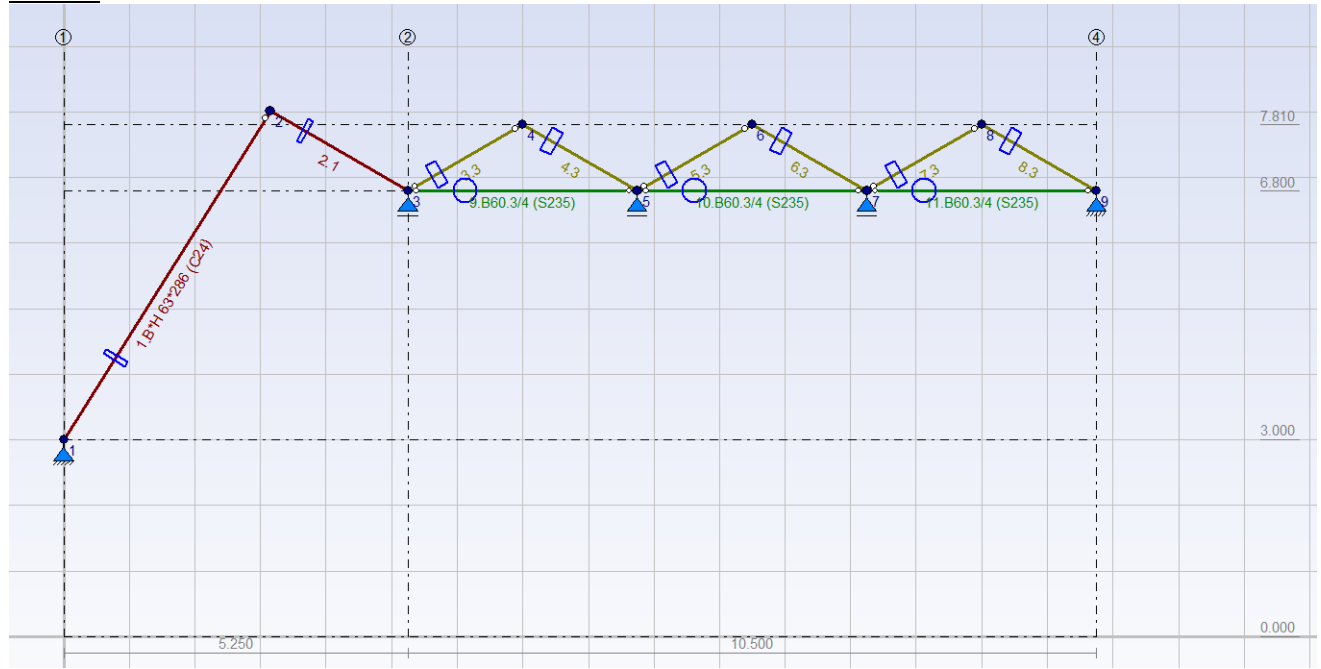

Technosoft Raamwerken release 6.84b

14 nov 2025

Project.....: 10745
 Onderdeel....: dsn schakeldak lage rand met trekstang
 Dimensies....: kN;m;rad (tenzij anders aangegeven)
 Bestand.....: N:\Order\10000\10700\10745\berekeningen en schetsen\dsn
 schakeldak lage rand met trekstang.rww

Belastingbreedte.: 1.000
 Theorie voor de bepaling van de krachtsverdeling: Geometrisch lineair.

Gunstige werking van de permanente belasting wordt automatisch verwerkt.

Toegepaste normen volgens Eurocode met Nederlandse NB

Belastingen	NEN-EN 1990:2002	C2:2010, A1:2019	NB:2019(nl)
	NEN-EN 1991-1-1:2002	C1/C11:2019	NB:2019(nl)
	NEN-EN 1991-1-3:2003	A1:2019	NB:2019(nl)
	NEN-EN 1991-1-4:2005	C2:2023	NB:2019(nl)

OMHULLENDE VAN DE FUNDAMENTELE COMBINATIES

MOMENTEN

Fundamentele combinatie

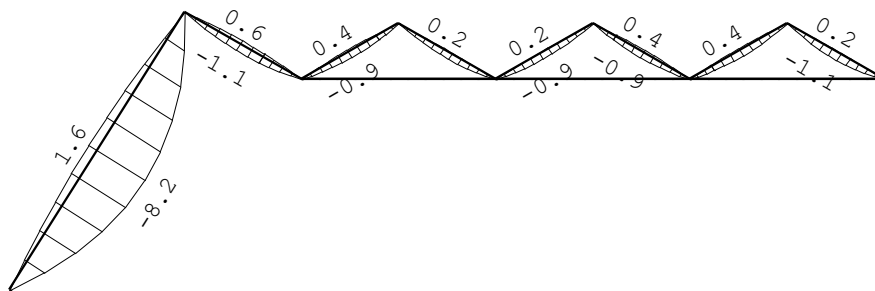

Project.....: 10745
 Onderdeel....: dsn schakeldak lage rand met trekstang

DWARSKRACHTEN

Fundamentele combinatie

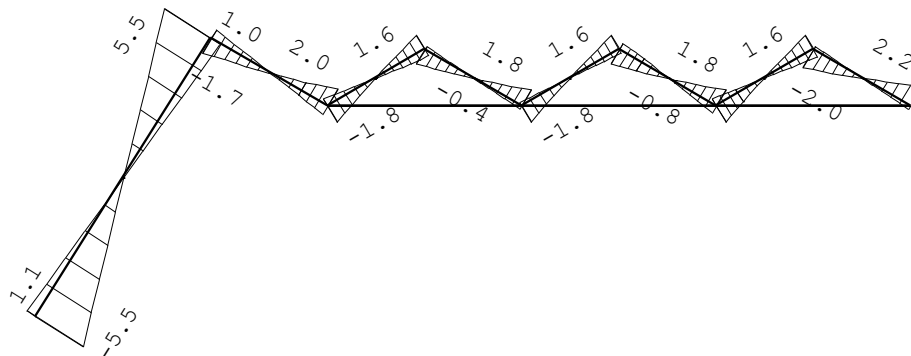

NORMAALKRACHTEN

Fundamentele combinatie

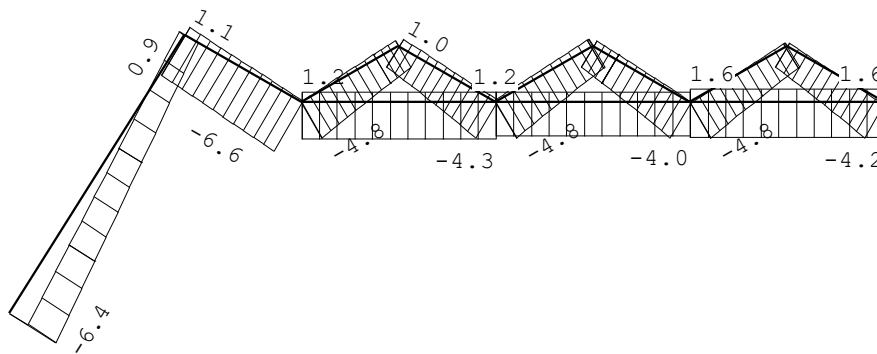

STAAFKRACHTEN

Fundamentele combinatie

St.	Kn.	Pos.	NXi/NXj		DZi/DZj		MYi/MYj							
			Min	Max	Min	Max	Min	Max	Min	Max				
1	1		-6.44	7	-2.50	10	-5.55	3	1.09	12	0.00	3	0.00	12
1		2.957	-4.10	7	-0.81	10	-0.00	3	0.00	12	-8.18	3	1.61	12
1		2.960	-4.10	7	-0.81	10	0.00	1	0.00	10	-8.18	3	1.61	12
1	2		-1.77	7	0.88	10	-1.09	12	5.53	3	-0.00	3	0.00	12
2	2		-5.53	3	1.10	12	-1.71	7	1.00	10	0.00	7	0.00	10
2		1.212	-6.08	3	0.69	12	-0.12	8	0.00	10	-1.05	8	0.60	10
2		1.272	-6.10	3	0.67	12	-0.05	14	0.08	7	-1.06	8	0.60	10
2		1.297	-6.12	3	0.66	12	-0.07	10	0.12	7	-1.06	8	0.60	10
2	3		-6.62	3	0.28	12	-1.00	10	1.98	8	-0.00	8	0.00	10
3	3		-4.85	8	0.16	10	-1.85	8	0.82	10	0.00	8	0.00	10
3		0.980	-3.78	8	0.50	10	-0.04	7	0.01	12	-0.88	8	0.40	10
3		0.983	-3.78	8	0.50	10	-0.04	7	0.01	12	-0.88	8	0.40	10
3		0.993	-3.77	8	0.50	10	-0.03	7	0.03	14	-0.88	8	0.40	10
3		1.010	-3.75	8	0.51	10	-0.01	3	0.05	14	-0.88	8	0.40	10
3	4		-2.83	8	0.85	10	-0.72	10	1.64	8	0.00	8	0.00	10

Project.....: 10745
 Onderdeel....: dsn schakeldak lage rand met trekstang

STAAFKRACHTEN

Fundamentele combinatie

St.	Kn.	Pos.	NXi/NXj		DZi/DZj		MYi/MYj							
			Min	BC	Max	BC	Min	BC	Max	BC	Min	BC	Max	BC
4	4		-2.83	8	1.04	10	-1.64	8	0.38	10	0.00	8	0.00	10
4		1.010	-3.75	8	0.70	10	-0.05	8	0.00	10	-0.88	8	0.19	10
4		1.038	-3.78	8	0.69	10	-0.01	14	0.04	7	-0.88	8	0.19	10
4		1.041	-3.78	8	0.69	10	-0.01	10	0.04	7	-0.88	8	0.19	10
4	5		-4.85	8	0.36	10	-0.38	10	1.85	8	-0.00	8	0.00	10
5	5		-4.85	8	0.36	12	-1.85	8	0.38	12	0.00	8	0.00	12
5		0.980	-3.78	8	0.69	12	-0.04	7	0.01	12	-0.88	8	0.19	12
5		0.983	-3.78	8	0.69	12	-0.04	7	0.01	12	-0.88	8	0.19	12
5		1.010	-3.75	8	0.70	12	0.00	7	0.05	14	-0.88	8	0.19	12
5	6		-2.83	8	1.04	12	-0.38	12	1.64	8	0.00	8	0.00	12
6	6		-2.83	8	0.85	12	-1.64	8	0.72	12	0.00	8	0.00	12
6		1.010	-3.75	8	0.51	12	-0.05	8	0.01	12	-0.88	8	0.40	12
6		1.028	-3.77	8	0.50	12	-0.03	14	0.03	7	-0.88	8	0.40	12
6		1.038	-3.78	8	0.50	12	-0.01	14	0.04	7	-0.88	8	0.40	12
6		1.041	-3.78	8	0.50	12	-0.01	10	0.04	7	-0.88	8	0.40	12
6	7		-4.85	8	0.16	12	-0.82	12	1.85	8	-0.00	8	0.00	12
7	7		-4.85	8	-0.13	10	-1.85	8	0.83	12	0.00	8	0.00	12
7		0.980	-3.78	8	0.20	10	-0.04	7	0.03	12	-0.88	8	0.42	12
7		0.988	-3.77	8	0.20	10	-0.03	7	0.02	12	-0.88	8	0.42	12
7		1.010	-3.75	8	0.21	10	0.00	7	0.05	14	-0.88	8	0.42	12
7	8		-2.83	8	0.55	10	-0.83	12	1.64	8	0.00	8	0.00	12
8	8		-2.83	8	0.45	10	-2.04	5	0.38	10	0.00	5	0.00	10
8		1.010	-3.75	8	0.11	10	-0.05	8	0.00	10	-1.09	5	0.19	10
8		1.020	-3.76	8	0.11	10	-0.04	14	0.01	7	-1.09	5	0.19	10
8		1.038	-3.78	8	0.10	10	-0.01	14	0.04	7	-1.09	5	0.19	10
8	9		-4.85	8	-0.23	10	-0.38	10	2.19	5	-0.00	5	0.00	10
9	3		-4.32	3	1.25	14	0.00	1	0.00	1	0.00	1	0.00	1
9	5		-4.32	3	1.25	14	0.00	1	0.00	1	0.00	1	0.00	1
10	5		-3.98	3	1.25	14	0.00	1	0.00	1	0.00	1	0.00	1
10	7		-3.98	3	1.25	14	0.00	1	0.00	1	0.00	1	0.00	1
11	7		-4.15	3	1.62	12	0.00	1	0.00	1	0.00	1	0.00	1
11	9		-4.15	3	1.62	12	0.00	1	0.00	1	0.00	1	0.00	1

REACTIES

Fundamentele combinatie

Kn.	X-min	X-max	Z-min	Z-max	M-min	M-max
1	-2.57	3.00	2.04	7.03		
3			-0.56	7.50		
5			-0.62	8.05		
7			-0.75	8.05		
9	-5.64	1.93	-0.21	4.02		

Normaalkracht N_{Ed} per m^1 is 4.33 kN
 Drukkoker h.o.h. 4.0 m toepassen.

$N_k = 4.33 / 1.50 * 4.00 \text{ m} = 11.54 \text{ kN}$
 $M_k = 11.54 * 0.03 = 0.35 \text{ kNm}$

Project.....: 10745
 Onderdeel....: Drukstaaf schakeldak
 Dimensies....: kN;m;rad (tenzij anders aangegeven)
 Bestand.....: N:\Order\10000\10700\10745\berekeningen en
 schetsen\Drukstaaf schakeldak.rww

Belastingbreedte.: 1.000
 Rekenmodel.....: 1e-orde-elastisch.
 Theorie voor de bepaling van de krachtsverdeling:
 Geometrisch lineair.
 Fysisch lineair.

Gunstige werking van de permanente belasting wordt automatisch verwerkt.

Toegepaste normen volgens Eurocode met Nederlandse NB

Belastingen	NEN-EN 1990:2002	C2:2010,A1:2019	NB:2019(nl)
	NEN-EN 1991-1-1:2002	C1/C11:2019	NB:2019(nl)
	NEN-EN 1991-1-3:2003	A1:2019	NB:2019(nl)
Staal	NEN-EN 1993-1-1:2006	C2:2011,A1:2016	NB:2016(nl)

GEOMETRIE

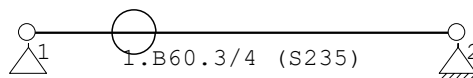

MATERIALEN

Mt	Kwaliteit	E-modulus[N/mm2]	S.G.	Pois.	Uitz. coëff
1	S235	210000	78.5	0.30	1.2000e-05

PROFIELEN [mm]

Prof.	Omschrijving	Materiaal	Oppervlak	Traagheid	Vormf.
1	B60.3/4	1:S235	7.0749e+02	2.8173e+05	0.00

PROFIELEN vervolg [mm]

Prof.	Staaftype	Breedte	Hoogte	e	Type	b1	h1	b2	h2
1	0:Normaal	60	60	30.2					

PROFIELVORMEN [mm]

1 B60.3/4



KNOPEN

Knoop	X	Z
1	0.000	0.000
2	3.500	0.000

Project.....: 10745
 Onderdeel....: Drukstaaf schakeldak

STAVEN

St.	ki	kj	Profiel	Aansl.i	Aansl.j	Lengte	Opm.
1	1	2	1:B60.3/4	NDM	NDM	3.500	

VASTE STEUNPUNTEN

Nr.	knoop	Kode	XZR	1=vast	0=vrij	Hoek
1	1	010				0.00
2	2	110				0.00

BELASTINGGEVALLEN

B.G.	Omschrijving	EGZ	Type
1	Permanente belasting	EGZ=-1.00	1
2	Sneeuw A		22

BELASTINGEN

B.G:1 Permanente belasting

Eigen gewicht van alle staven is meegenomen in berekening. Richting:↓

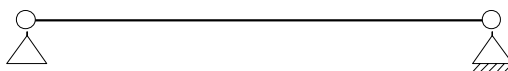

REACTIES

B.G:1 Permanente belasting

Kn.	X	Z	M
1		0.10	
2	0.00	0.10	
	0.00	0.19	: Som van de reacties
	0.00	-0.19	: Som van de belastingen

BELASTINGEN

B.G:2 Sneeuw A

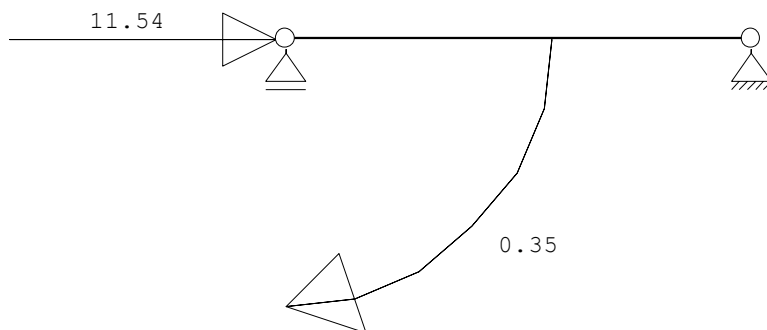

KNOOPBELASTINGEN

B.G:2 Sneeuw A

Last	Knoop	Richting	waarde	Ψ_0	Ψ_1	Ψ_2
1	1	X	11.540	0.00	0.20	0.00
2	1	Rotatie Y	0.350	0.00	0.20	0.00

REACTIES

B.G:2 Sneeuw A

Kn.	X	Z	M
1		-0.10	
2	-11.54	0.10	
	-11.54	0.00	: Som van de reacties
	11.54	0.00	: Som van de belastingen

Project.....: 10745
 Onderdeel....: Drukstaaf schakeldak

BELASTINGCOMBINATIES

BC Type	BG Gen.	Factor	BG Gen.	Factor	BG Gen.	Factor	BG Gen.	Factor
1 Fund.	1 Perm	1.35						
2 Fund.	1 Perm	0.90						
3 Fund.	1 Perm	1.20	2 Extr	1.50				
4 Fund.	1 Perm	0.90	2 Extr	1.50				
5 Kar.	1 Perm	1.00	2 Extr	1.00				
6 Blij.	1 Perm	1.00						

GUNSTIGE WERKING PERMANENTE BELASTINGEN

BC Staven met gunstige werking
1 Geen
2 Alle staven de factor:0.90
3 Geen
4 Alle staven de factor:0.90

OMHULLENDE VAN DE FUNDAMENTELE COMBINATIES

MOMENTEN

Fundamentele combinatie

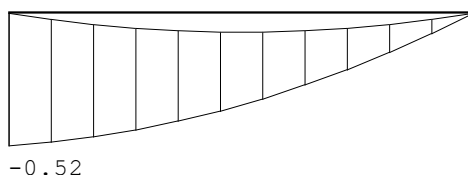

DWARSKRACHTEN

Fundamentele combinatie

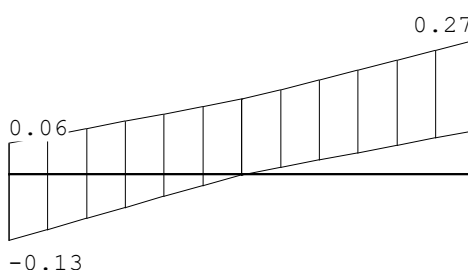

Project.....: 10745
 Onderdeel....: Drukstaaf schakeldak

NORMAALKRACHTEN

Fundamentele combinatie

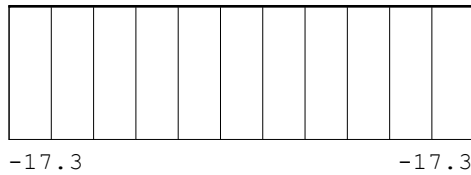

STAAFKRACHTEN

Fundamentele combinatie

St.	Kn.	Pos.	NXi/NXj		DZi/DZj				MYi/MYj					
			Min BC	Max BC	Min BC	Max BC	Min BC	Max BC	Min BC	Max BC				
1	1		-17.31	3	0.00	1	-0.13	1	0.06	4	-0.52	3	0.00	2
	1	1.750	-17.31	3	0.00	1	0.00	1	0.15	4	-0.36	3	-0.08	2
	1	2	-17.31	3	0.00	1	0.09	2	0.27	3	0.00	3	0.00	2

REACTIES

Fundamentele combinatie

Kn.	X-min	X-max	Z-min	Z-max	M-min	M-max
1			-0.06	0.13		
2	-17.31	0.00	0.09	0.27		

STAALPROFIELEN - ALGEMENE GEGEVENS

Stabiliteit: Classificatie gehele constructie: Geschoord

PROFIEL/MATERIAAL

P/M nr.	Profielnaam	Vloeisp. [N/mm ²]	Productie methode	Min. drsn. klasse
1	B60.3/4	235	Warmgewalst	1

Partiële veiligheidsfactoren:

Gamma M;0	:	1.00	Gamma M;1	:	1.00
Gamma M;fi;mech	:	1.00	Gamma M;fi;therm	:	1.00

KNIKSTABILITEIT

StAAF	l _{sys} [m]	Classif. y sterke as	l _{knik;y} [m]	Extra		l _{knik;z} [m]	aanp. z [kN]
				aanp. y [kN]	Classif. z zwakke as		
1	3.500	Geschoord	3.500	0.0	Geschoord	3.500	0.0

KIPSTABILITEIT

StAAF	Plts. aangr.	l gaffel [m]	Kipsteunafstanden [m]
1	1.0*h	boven:	3.50 3.500
		onder:	3.500

TOETSING SPANNINGEN

StAAF nr.	P/M	BC	Sit	Kl	Plaats	Norm	Artikel	Formule	Hoogste toetsing U.C. [N/mm ²]	Opm.
1	1	3	1	1	StAAF	EN3-1-1	6.3.3	(6.61)	0.589	138

Wapening druklaag

$M_{Ed} = 1/8 * 4.33 * 11.25^2 = 68.5 \text{ kNm}$

hoogte = $0.9 * 2.20 = \pm 2.0 \text{ m}$

$N_{Ed} = 68.5 / 2.0 = 34.3 \text{ kN geeft}$ $As = 34300 / 435 = \pm 79 \text{ mm}^2$ #6-150 mobiliseert 3 staven 85 mm²

$V_{Ed} = 4.33 * 11.25 * 0.5 = 24.4 \text{ kN}$

$\tau = 24400 / (200 * 2200) = 0.055 \text{ N/mm}^2 < 0.1 \text{ N/mm}^2$ akkoord

3.1.3 Dakligger as B en C

Maatgevend as C.

q-1 blijvende belasting

dak_schuin_fundering $0.87 * 5.25 * 0.5 = 2.28 \text{ kN/m}^1$

dak_plat_beton $5.00 * 2.75 = 13.75 \text{ kN/m}^1$

eg_ligger $0.36 = 0.36 \text{ kN/m}^1$

$g_k \text{ totaal} = 16.39 \text{ kN/m}^1$

q-1 opgelegde belasting

sneeuw_aang_gem $1.12 * 5.38$

$= 6.03 \text{ kN/m}^1$
 $q_k \text{ totaal} = 6.03 \text{ kN/m}^1$

Belasting combinaties

$q \ g_k = 16.39 \text{ kN/m}^1$

$q \ q_k = 6.03 \text{ kN/m}^1$

$\psi_0 = 0.0$

$\psi_1 = 0.2$

$\psi_2 = 0.0$

$q_{inst} = 16.39 + 6.03 = 22.42 \text{ kN/m}^1$

$q_{freq,6.15} = 16.39 + 6.03 * 0.2 = 17.60 \text{ kN/m}^1$

$q_{d,6.10a} = 1.35 * 16.39 + 1.50 * 6.03 * 0.0 = 22.13 \text{ kN/m}^1$

$q_{d,6.10b} = 1.20 * 16.39 + 1.50 * 6.03 = 28.71 \text{ kN/m}^1$

Mechanica schema

Lengte = 2900 mm

$R_{A,Ed} = 1/2 * 28.71 * 2.90 = 41.63 \text{ kN}$ g_k 23.77 q_k 8.74

$R_{B,Ed} = 1/2 * 28.71 * 2.90 = 41.63 \text{ kN}$ g_k 23.77 q_k 8.74

$M_{Ed} = 1/8 * 28.71 * 2.90^2 = 30.18 \text{ kNm}$ g_k 17.23 q_k 6.34

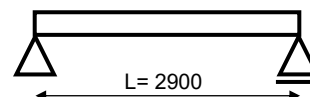

Profiel gegevens

Profiel = HEA180 ($W_y = 294 * 10^3 \text{ mm}^3$, $I_y = 2510 * 10^4 \text{ mm}^4$)

Reductie $\chi_{LT} = 1.00$

Kwaliteitsklasse = S 235

Elasticiteitsmodulus = $2.1 * 10^5 \text{ N/mm}^2$

Controle op buigsterkte

$M_{Ed} = 30.18 \text{ kNm}$

$M_{Rd} = 294 * 10^3 * 235 / 10^6 = 69.09 \text{ kNm}$ UC = 0.44

Controle op doorbuiging

$w_G = 2.86 \text{ mm}$ Zeeg = 0 mm

$w_{inst} = 3.92 \text{ mm}$

$w_{bij} = 1.05 \text{ mm} < 0.004 * \text{lengte} = 11.60 \text{ mm}$ UC = 0.09

$w_{fin} = 3.92 \text{ mm} < 0.004 * \text{lengte} = 11.60 \text{ mm}$ UC = 0.34

Controle oplegging

$R_{Ed} = 41.63 \text{ kN}$ Opleggen op metselwerk

oplegbreedte = 180 mm

opleglengte = 150 mm

$\sigma_{Ed} = 41.63 * 10^3 / (180 * 150) = 1.54 \text{ N/mm}^2 < 2.14 \text{ N/mm}^2$ UC = 0.72

3.1.4 Dakligger as 4

q-1 blijvende belasting				
dak_schuin_fundering	$0.87 * 1.75$	=	1.52 kN/m^1	
verdiepingsvloer_D200	$6.15 * 1.10$	=	6.77 kN/m^1	
eg ligger	0.36	=	0.36 kN/m^1	
		g_k totaal	= 8.65 kN/m^1	
q-1 opgelegde belasting				
sneeuw_aang_gem	$1.12 * (1.75+1.10)$		$= 3.19 \text{ kN/m}^1$	
		q_k totaal	= 3.19 kN/m^1	

Belasting combinaties

q g _k	= 8.65 kN/m^1	$\psi_0 = 0.0$
q q _k	= 3.19 kN/m^1	$\psi_1 = 0.2$
		$\psi_2 = 0.0$

q _{inst}	= $8.65+3.19$	= 11.84 kN/m^1
q _{freq,6.15}	= $8.65+3.19*0.2$	= 9.29 kN/m^1
q _{d,6.10a}	= $1.35*8.65+1.50*3.19*0.0$	= 11.68 kN/m^1
q _{d,6.10b}	= $1.20*8.65+1.50*3.19$	= 15.17 kN/m^1

Mechanica schema

Lengte	= 2000 mm				
R _{A,Ed}	= $1/2 * 15.17 * 2.00$	= 15.17 kN	g_k	q_k	
R _{B,Ed}	= $1/2 * 15.17 * 2.00$	= 15.17 kN	8.65	3.19	
M _{Ed}	= $1/8 * 15.17 * 2.00^2$	= 7.59 kNm	4.33	1.60	

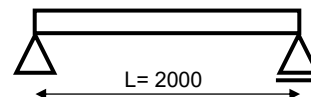

Profiel gegevens

Profiel	= HEA180	(W _y = 294 * 10 ³ mm ³ ,	l _y = 2510 * 10 ⁴ mm ⁴)
Reductie χ_{LT}	= 1.00		
Kwaliteitsklasse	= S 235		
Elasticiteitsmodulus	= 2.1 * 10 ⁵ N/mm ²		

Controle op buigsterkte

M _{Ed}	= 7.59 kNm		
M _{Rd}	= $294 * 10^3 * 235 / 10^6$	= 69.09 kNm	UC = 0.11

Controle op doorbuiging

W _G	= 0.34 mm	Zeeg = 0 mm	
W _{inst}	= 0.47 mm		
W _{bij}	= 0.13 mm	< 0.004 * lengte = 8.00 mm	UC = 0.02
W _{fin}	= 0.47 mm	< 0.004 * lengte = 8.00 mm	UC = 0.06

Controle oplegging

R _{Ed}	= 15.17 kN	Opleggen op metselwerk	
oplegbreedte	= 180 mm		
opleglengte	= 150 mm		
σ_{Ed}	= $15.17 * 10^3 / (180 * 150)$	= 0.56 N/mm ²	< 2.50 N/mm ² UC = 0.22

3.2 Kolom as E

$N_{Ed} = 62.63 / 1.5 = 41.8 \text{ kN}$ (uit paragraaf 2.2 Ligger schakeldak)
 $M_{Ed} = 41.8 * 0.075 = 3.1 \text{ kNm}$

Technosoft Raamwerken release 6.84b

20 nov 2025

Project.....: 10745
Onderdeel....: Kolom as E
Dimensies....: kN;m;rad (tenzij anders aangegeven)
Bestand.....: N:\Order\10000\10700\10745\berekeningen en schetsen\Kolom
as E.rww

Belastingbreedte.: 1.000
Rekenmodel.....: 1e-orde-elastisch.
Theorie voor de bepaling van de krachtsverdeling:
Geometrisch lineair.
Fysisch lineair.

Gunstige werking van de permanente belasting wordt automatisch verwerkt.

Toegepaste normen volgens Eurocode met Nederlandse NB

Belastingen	NEN-EN 1990:2002	C2:2010,A1:2019	NB:2019(nl)
	NEN-EN 1991-1-1:2002	C1/C11:2019	NB:2019(nl)
	NEN-EN 1991-1-3:2003	A1:2019	NB:2019(nl)
Staal	NEN-EN 1993-1-1:2006	C2:2011,A1:2016	NB:2016(nl)



GEOMETRIE

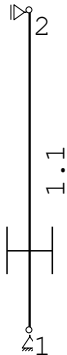

MATERIALEN

Mt	Kwaliteit	E-modulus [N/mm ²]	S.G.	Pois.	Uitz. coëff
1	S235	210000	78.5	0.30	1.2000e-05

PROFIELEN [mm]

Prof.	Omschrijving	Materiaal	Oppervlak	Traagheid	Vormf.
1	HEA160	1:S235	3.8800e+03	1.6730e+07	0.00

Project.....: 10745
 Onderdeel....: Kolom as E

PROFIELEN vervolg [mm]

Prof.	Staaftype	Breedte	Hoogte	e	Type	b1	h1	b2	h2
1	0:Normaal	160	152	76.0					

PROFIELVORMEN [mm]

1 HEA160



KNOPEN

Knoop	X	Z
1	0.000	0.000
2	0.000	6.200

STAVEN

St.	ki	kj	Profiel	Aansl.i	Aansl.j	Lengte	Opm.
1	1	2	1:HEA160	NDM	NDM	6.200	

VASTE STEUNPUNTEN

Nr.	knoop	Kode	XZR 1=vast 0=vrij	Hoek
1	1	110		0.00
2	2	100		0.00

BELASTINGGEVALLEN

B.G.	Omschrijving	EGZ	Type
1	Permanente belasting	EGZ=-1.00	1
2	Sneeuw A		22

BELASTINGEN

B.G:1 Permanente belasting

Eigen gewicht van alle staven is meegenomen in berekening. Richting:↓



Project.....: 10745
 Onderdeel....: Kolom as E

BELASTINGEN

B.G:2 Sneeuw A

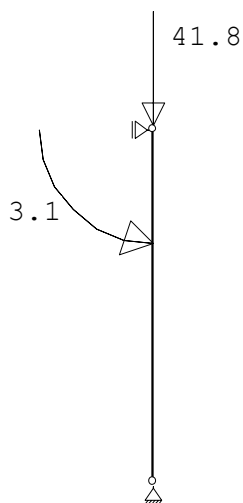

KNOOPBELASTINGEN

B.G:2 Sneeuw A

Last Knoop	Richting	waarde	Ψ_0	Ψ_1	Ψ_2
1	2 Z	-41.800	0.00	0.20	0.00
2	2 Rotatie Y	-3.100	0.00	0.20	0.00

REACTIES

Kn.	B.G.	X	Z	M
1	1	0.00	1.89	
1	2	-0.50	41.80	
2	1	0.00		
2	2	0.50		

BELASTINGCOMBINATIES

BC Type	BG	Gen. Factor	BG	Gen. Factor	BG	Gen. Factor	BG	Gen. Factor
1 Fund.	1 Perm	1.35						
2 Fund.	1 Perm	0.90						
3 Fund.	1 Perm	1.20	2 Extr	1.50				
4 Fund.	1 Perm	0.90	2 Extr	1.50				
5 Kar.	1 Perm	1.00	2 Extr	1.00				
6 Blij.	1 Perm	1.00						

GUNSTIGE WERKING PERMANENTE BELASTINGEN

BC Staven met gunstige werking
1 Geen
2 Alle staven de factor:0.90
3 Geen
4 Alle staven de factor:0.90

Project.....: 10745
Onderdeel....: Kolom as E

OMHULLENDE VAN DE FUNDAMENTELE COMBINATIES

MOMENTEN

Fundamentele combinatie

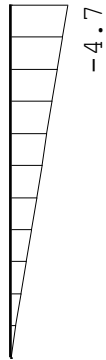

DWARSKRACHTEN

Fundamentele combinatie

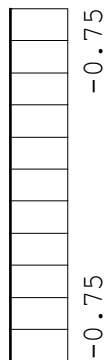

Project.....: 10745
 Onderdeel....: Kolom as E

NORMAALKRACHTEN

Fundamentele combinatie

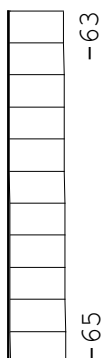

STAAFKRACHTEN

Fundamentele combinatie

St.	Kn.	Pos.	NXi/NXj		DZi/DZj		MYi/MYj							
			Min BC	Max BC	Min BC	Max BC	Min BC	Max BC						
1	1		-64.97	3	-1.70	2	-0.75	3	0.00	1	0.00	3	0.00	1
1	2		-62.70	3	0.00	2	-0.75	3	0.00	1	-4.65	3	0.00	1

REACTIES

Fundamentele combinatie

Kn.	X-min	X-max	Z-min	Z-max	M-min	M-max
1	-0.75	0.00	1.70	64.97		
2	0.00	0.75				

STAALPROFIELEN - ALGEMENE GEGEVENS

Stabiliteit: Classificatie gehele constructie: Geschoord
 Doorbuiging en verplaatsing:
 Aantal bouwlagen: 1
 Gebouwtype: Overig
 Toel. horiz. verplaatsing gehele gebouw: h/300
 Kleinste gevelhoogte [m]: 0.0

PROFIEL/MATERIAAL

P/M nr.	Profielnaam	Vloeispr. [N/mm ²]	Productie methode	Min. drsn. klasse
1	HEA160	235	Gewalst	1

Partiële veiligheidsfactoren:
 Gamma M;0 : 1.00 Gamma M;1 : 1.00
 Gamma M;fi;mech : 1.00 Gamma M;fi;therm : 1.00

KNIKSTABILITEIT

Staafl	l _{sys} [m]	Classif. y sterke as	l _{knik;y} [m]	Extra		l _{knik;z} [m]	Extra	
				aanp. y [kN]	Classif. z zwakke as		aanp. z [kN]	
1	6.200	Geschoord	6.200	0.0	Geschoord	6.200	0.0	

Project.....: 10745
Onderdeel....: Kolom as E

KIPSTABILITEIT

StAAF	Plts. aangr.	1 gaffel	Kipsteunafstanden	
			[m]	[m]
1	1.0*h	boven:	6.20	6.2
		onder:		6.2

TOETSING SPANNINGEN

StAAF	P/M	BC	Sit	Kl	Plaats	Norm	Artikel	Formule	Hoogste toetsing U.C. [N/mm ²]	Opm.
	nr.									
1	1	3	1	1	StAAF	EN3-1-1	6.3.3	(6.62)	0.340	80

3.3 Niveau verdieping

3.3.1 Randligger as 1 / A-B

q-1	blijvende belasting				
pui		1.00 * 3.00	=	3.00 kN/m ¹	
verdiepingsvloer_D200		6.15 * 2.60	=	15.99 kN/m ¹	
eg ligger		0.95	=	0.95 kN/m ¹	
			g_k totaal	= 19.94 kN/m¹	
q-1	opgelegde belasting				
verdiepingsvloer_D200		5.00 * 2.60		= 13.00 kN/m ¹	
			q_k totaal	= 13.00 kN/m¹	

Belasting combinaties

q g _k	= 19.94 kN/m ¹		ψ ₀ = 0.4
q q _k	= 13.00 kN/m ¹		ψ ₁ = 0.7
			ψ ₂ = 0.6
q _{inst}	= 19.94+13.00	= 32.94 kN/m ¹	
q _{freq,6.15}	= 19.94+13.00*0.7	= 29.04 kN/m ¹	
q _{d,6.10a}	= 1.35*19.94+1.50*13.00*0.4	= 34.72 kN/m ¹	
q _{d,6.10b}	= 1.20*19.94+1.50*13.00	= 43.43 kN/m ¹	

Mechanica schema

Lengte	= 5250 mm				
R _{A,Ed}	= 1/2*43.43*5.25	= 114.00 kN	g _k	q _k	
R _{B,Ed}	= 1/2*43.43*5.25	= 114.00 kN	52.34	34.13	
M _{Ed}	= 1/8* 43.43*5.25 ²	= 149.63 kNm	68.70	44.79	

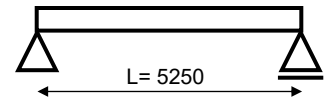

Profiel gegevens

Profiel	= HEB260	(W _y = 1150 *10 ³ mm ³ ,	l _y = 14919 *10 ⁴ mm ⁴)
Reductie χ _{LT}	= 1.00		
Kwaliteitsklasse	= S 235		
Elasticiteitsmodulus	= 2.1*10 ⁵ N/mm ²		

Controle op buigsterkte

M _{Ed}	= 149.63 kNm		
M _{Rd}	= 1150*10 ³ *235/10 ⁶	= 270.25 kNm	UC = 0.55

Controle op doorbuiging

w _G	= 6.30 mm	Zeeg	= 0 mm	
w _{inst}	= 10.40 mm			
w _{bij}	= 4.10 mm	< 0.002	* lengte = 10.50 mm	UC = 0.39
w _{fin}	= 10.40 mm	< 0.004	* lengte = 21.00 mm	UC = 0.50

Ronding vloer aanstorten D200 + 50 = D250mm

3.3.2 Randligger as 1 / B-C

lengte = 5.50 m

belasting

stuwdruk_qp	0.94 * (0.8+0.3) * 5.00 * 0.5	= 2.59 kN/m ¹
stuwdruk_qp	0.94 * (0.8+0.3) * 6.60 * 5.25 * 0.5	= 17.91 kN
stuwdruk_qp	0.94 * (0.8+0.3) * 6.60 * 3.00 * 0.5	= 10.24 kN
	Totaal	= 28.15 kN

Project.....: 10745
 Onderdeel....: Ligger verdieping as 1_B-C
 Dimensies....: kN;m;rad (tenzij anders aangegeven)
 Bestand.....: N:\Order\10000\10700\10745\berekeningen en
 schetsen\Ligger verdieping as 1_B-C.rww

Belastingbreedte.: 1.000
 Rekenmodel.....: 1e-orde-elastisch.
 Theorie voor de bepaling van de krachtsverdeling:
 Geometrisch lineair.
 Fysisch lineair.

Gunstige werking van de permanente belasting wordt automatisch verwerkt.

Toegepaste normen volgens Eurocode met Nederlandse NB

Belastingen	NEN-EN 1990:2002	C2:2010,A1:2019	NB:2019(nl)
	NEN-EN 1991-1-1:2002	C1/C11:2019	NB:2019(nl)
	NEN-EN 1991-1-3:2003	A1:2019	NB:2019(nl)
Staal	NEN-EN 1993-1-1:2006	C2:2011,A1:2016	NB:2016(nl)

GEOMETRIE

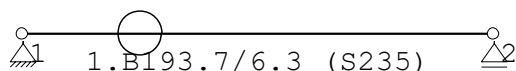

MATERIALEN

Mt	Kwaliteit	E-modulus [N/mm ²]	S.G.	Pois.	Uitz. coëff
1	S235	210000	78.5	0.30	1.2000e-05

PROFIELEN [mm]

Prof.	Omschrijving	Materiaal	Oppervlak	Traagheid	Vormf.
1	B193.7/6.3	1:S235	3.7090e+03	1.6300e+07	0.00

PROFIELEN vervolg [mm]

Prof.	Staaftype	Breedte	Hoogte	e	Type	b1	h1	b2	h2
1	0:Normaal	194	194	96.9					

PROFIELVORMEN [mm]

1	B193.7/6.3
---	------------



KNOPEN

Knoop	X	Z
1	0.000	0.000
2	5.500	0.000

Project.....: 10745
 Onderdeel....: Ligger verdieping as 1_B-C

STAVEN

St.	ki	kj	Profiel	Aansl.i	Aansl.j	Lengte	Opm.
1	1	2	1:B193.7/6.3	NDM	NDM	5.500	

VASTE STEUNPUNTEN

Nr.	knoop	Kode	XZR 1=vast 0=vrij	Hoek
1	1	110		0.00
2	2	010		0.00

BELASTINGGEVALLEN

B.G.	Omschrijving	EGZ	Type
1	Permanente belasting	-1.00	1
2	Sneeuw A		22

BELASTINGEN

B.G:1 Permanente belasting

Eigen gewicht van alle staven is meegenomen in berekening. Richting:↓

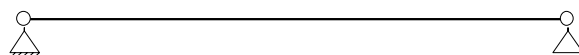

BELASTINGEN

B.G:2 Sneeuw A

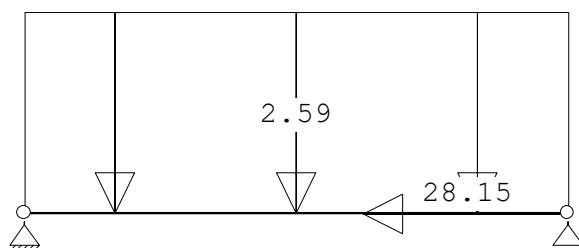

KNOOPBELASTINGEN

B.G:2 Sneeuw A

Last	Knoop	Richting	waarde	ψ_0	ψ_1	ψ_2
1	2	X	-28.150	0.00	0.20	0.00

STAAFBELASTINGEN

B.G:2 Sneeuw A

Staad	Type	q1/p/m	q2	A	B	ψ_0	ψ_1	ψ_2
1	3:QZgeProj.	-2.59	-2.59	0.000	0.000	0.00	0.20	0.00

REACTIES

Kn.	B.G.	X	Z	M
1	1	0.00	0.80	
1	2	28.15	7.12	
2	1		0.80	
2	2		7.12	

Project.....: 10745
 Onderdeel....: Ligger verdieping as 1_B-C

BELASTINGCOMBINATIES

BC Type	BG	Gen.	Factor	BG	Gen.	Factor	BG	Gen.	Factor	BG	Gen.	Factor
1	Fund.	1	Perm	1.35								
2	Fund.	1	Perm	0.90								
3	Fund.	1	Perm	1.20	2	Extr	1.50					
4	Fund.	1	Perm	0.90	2	Extr	1.50					
5	Kar.	1	Perm	1.00	2	Extr	1.00					
6	Quas.	1	Perm	1.00								
7	Freq.	1	Perm	1.00								
8	Freq.	1	Perm	1.00	2	psil	1.00					
9	Blij.	1	Perm	1.00								

GUNSTIGE WERKING PERMANENTE BELASTINGEN

BC Staven met gunstige werking
1 Geen
2 Alle staven de factor:0.90
3 Geen
4 Alle staven de factor:0.90

OMHULLENDE VAN DE FUNDAMENTELE COMBINATIES

MOMENTEN

Fundamentele combinatie

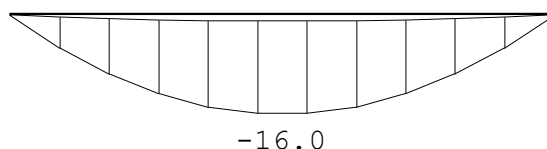

DWARSKRACHTEN

Fundamentele combinatie

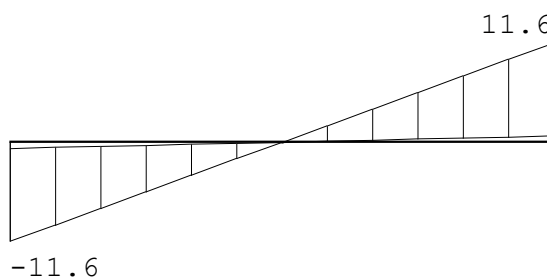

STAAFKRACHTEN

Fundamentele combinatie

St.	Kn.	Pos.	NXi/NXj		DZi/DZj				MYi/MYj					
			Min BC	Max BC	Min BC	Max BC	Min BC	Max BC	Min BC	Max BC				
1	1		-42.22	3	0.00	1	-11.64	3	-0.72	2	0.00	3	0.00	2
1	2	750	-42.22	3	0.00	1	-0.00	3	0.00	2	-16.01	3	-0.99	2
1	2		-42.22	3	0.00	1	0.72	2	11.64	3	-0.00	3	0.00	2

REACTIES

Fundamentele combinatie

Kn.	X-min	X-max	Z-min	Z-max	M-min	M-max
-----	-------	-------	-------	-------	-------	-------

Project.....: 10745
 Onderdeel....: Ligger verdieping as 1_B-C

REACTIES

Kn.	Fundamentele combinatie					
	X-min	X-max	Z-min	Z-max	M-min	M-max
1	0.00	42.22	0.72	11.64		
2			0.72	11.64		

STAALPROFIELEN - ALGEMENE GEGEVENS

Stabiliteit: Classificatie gehele constructie: Geschoord

PROFIEL/MATERIAAL

P/M nr.	Profielnaam	Vloeisp. [N/mm ²]	Productie methode	Min. drsn. klasse
1	B193.7/6.3	235	Warmgewalst	1

Partiële veiligheidsfactoren:
 Gamma M;0 : 1.00 Gamma M;1 : 1.00

KNIKSTABILITEIT

Staafl	l _{sys} [m]	Classif. y sterke as	Extra		Extra		
			l _{knik;y} [m]	aanp. y [kN]	Classif. z zwakke as	l _{knik;z} [m]	aanp. z [kN]
1	5.500	Geschoord	5.500	0.0	Geschoord	5.500	0.0

KIPSTABILITEIT

Staafl	Plts. aangr.	1 gaffel Kipsteunafstanden	
		[m]	[m]
1	1.0*h	boven:	5.50
		onder:	5.5

TOETSING SPANNINGEN

Staafl nr.	P/M	BC	Sit	Kl	Plaats	Norm	Artikel	Formule	Hoogste toetsing U.C. [N/mm ²]	Opm.
1	1	3	1	1	Staafl	EN3-1-1	6.3.3	(6.61)	0.370	87

TOETSING DOORBUIGING

Staafl	Soort	Mtg	Lengte [m]	Overst		Zeeg [mm]	u _{tot} [mm]	BC	Sit	u [mm]	Toelaatbaar		
				I	J						[mm]	*1	
1	Vlr+w	db	5.50	N	N	0.0	-10.0	5	1	Eind	-10.0	±22.0	0.004
											5	1	Bijk

3.3.3 Randligger as 1 / C-E

q-1 blijvende belasting uit dak	4.52	=	4.52 kN/m ¹
verdiepingsvloer_D320	7.45 * 5.25	=	39.11 kN/m ¹
eg. ligger	1.42	=	1.42 kN/m ¹
		g_k totaal	= 45.05 kN/m¹
q-1 opgelegde belasting verdiepingsvloer_D320	5.00 * 5.25	=	26.25 kN/m ¹
		q_k totaal	= 26.25 kN/m¹

Belasting combinaties

q g _k	= 45.05 kN/m ¹	ψ ₀	= 0.4
q q _k	= 26.25 kN/m ¹	ψ ₁	= 0.7
		ψ ₂	= 0.6
q _{inst}	= 45.05+26.25		= 71.30 kN/m ¹
q _{freq,6.15}	= 45.05+26.25*0.7		= 63.43 kN/m ¹
q _{d,6.10a}	= 1.35*45.05+1.50*26.25*0.4		= 76.57 kN/m ¹
q _{d,6.10b}	= 1.20*45.05+1.50*26.25		= 93.44 kN/m ¹

Mechanica schema

Lengte	=	5625 mm		
R _{A,Ed}	=	1/2*93.44*5.63	=	262.80 kN
R _{B,Ed}	=	1/2*93.44*5.63	=	262.80 kN
			<i>g_k</i>	<i>q_k</i>
			126.70	73.83

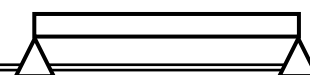

$$M_{Ed} = 1/8 * 93.44 * 5.63^2 = 369.56 \text{ kNm} \quad 178.18 \quad 103.82$$

L = 5625

Profiel gegevens

Profiel = HEA450 ($W_y = 2900 * 10^3 \text{ mm}^3$, $I_y = 63722 * 10^4 \text{ mm}^4$)
 Reductie χ_{LT} = 1.00
 Kwaliteitsklasse = S 235
 Elasticiteitsmodulus = $2.1 * 10^5 \text{ N/mm}^2$

Controle op buigsterkte

$M_{Ed} = 369.56 \text{ kNm}$
 $M_{Rd} = 2900 * 10^3 * 235 / 10^6 = 681.50 \text{ KNm}$ UC = 0.54

Controle op doorbuiging

$w_G = 4.39 \text{ mm}$ Zeeg = 0 mm
 $w_{inst} = 6.95 \text{ mm}$
 $w_{bij} = 2.56 \text{ mm}$ < 0.002 * lengte = 11.25 mm UC = 0.23
 $w_{fin} = 6.95 \text{ mm}$ < 0.004 * lengte = 22.50 mm UC = 0.31

Tpv overkraging 1 m¹: $M_{Ed} = 0.5 * 93.44 * 1.0^2 = 46.72 \text{ kNm}$ $V_{Ed} = 93.44 * 1.00 = 93.44 \text{ kN}$

3.3.4 Tussenliggers as 2 en 3 / A-B

q-1 blijvende belasting

verdiepingsvloer_D200 $6.15 * 5.25 = 32.29 \text{ kN/m}^1$
 eg. ligger 1.05 = 1.05 kN/m^1
 g_k totaal = 33.34 kN/m^1

q-1 opgelegde belasting

verdiepingsvloer_D200 $5.00 * 5.25 = 26.25 \text{ kN/m}^1$
 q_k totaal = 26.25 kN/m^1

Belasting combinaties

q g_k = 33.34 kN/m^1 $\psi_0 = 0.4$
 q q_k = 26.25 kN/m^1 $\psi_1 = 0.7$
 $\psi_2 = 0.6$

$q_{inst} = 33.34 + 26.25 = 59.59 \text{ kN/m}^1$
 $q_{freq,6.15} = 33.34 + 26.25 * 0.7 = 51.72 \text{ kN/m}^1$
 $q_{d,6.10a} = 1.35 * 33.34 + 1.50 * 26.25 * 0.4 = 60.76 \text{ kN/m}^1$
 $q_{d,6.10b} = 1.20 * 33.34 + 1.50 * 26.25 = 79.38 \text{ kN/m}^1$

Mechanica schema

Lengte = 5250 mm
 $R_{A,Ed} = 1/2 * 79.38 * 5.25 = 208.37 \text{ kN}$ g_k 87.52 q_k 68.91
 $R_{B,Ed} = 1/2 * 79.38 * 5.25 = 208.37 \text{ kN}$ 87.52 68.91
 $M_{Ed} = 1/8 * 79.38 * 5.25^2 = 273.49 \text{ kNm}$ 114.87 90.44

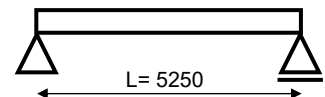

Profiel gegevens

Profiel = HEB280 ($W_y = 1380 * 10^3 \text{ mm}^3$, $I_y = 19270 * 10^4 \text{ mm}^4$)
 Reductie χ_{LT} = 1.00
 Kwaliteitsklasse = S 235
 Elasticiteitsmodulus = $2.1 * 10^5 \text{ N/mm}^2$

Controle op buigsterkte

$M_{Ed} = 273.49 \text{ kNm}$
 $M_{Rd} = 1380 * 10^3 * 235 / 10^6 = 324.30 \text{ KNm}$ UC = 0.84

Controle op doorbuiging

$w_G = 8.15 \text{ mm}$ Zeeg = 0 mm
 $w_{inst} = 14.57 \text{ mm}$
 $w_{bij} = 6.42 \text{ mm}$ < 0.002 * lengte = 10.50 mm UC = 0.61

$$w_{fin} = 14.57 \text{ mm} < 0.004 * \text{ lengte} = 21.00 \text{ mm} \quad UC = 0.69$$

3.3.5 Ligger as 2 / B-C

q-1 blijvende belasting verdiepingsvloer_D200 eg ligger	6.15 * 2.60 0.73	= =	15.99 kN/m ¹ 0.73 kN/m ¹
		g _k totaal =	16.72 kN/m ¹
q-1 opgelegde belasting verdiepingsvloer_D200	5.00 * 2.60	=	13.00 kN/m ¹
		q _k totaal =	13.00 kN/m ¹

Belasting combinaties

q g _k = 16.72 kN/m ¹		ψ ₀ = 0.4
q q _k = 13.00 kN/m ¹		ψ ₁ = 0.7
		ψ ₂ = 0.6
q _{inst} = 16.72+13.00	= 29.72 kN/m ¹	
q _{freq,6.15} = 16.72+13.00*0.7	= 25.82 kN/m ¹	
q _{d,6.10a} = 1.35*16.72+1.50*13.00*0.4	= 30.37 kN/m ¹	
q _{d,6.10b} = 1.20*16.72+1.50*13.00	= 39.56 kN/m ¹	

Mechanica schema

Lengte = 5500 mm			
R _{A,Ed} = 1/2*39.56*5.50	= 108.79 kN	g _k 45.98	q _k 35.75
R _{B,Ed} = 1/2*39.56*5.50	= 108.79 kN	45.98	35.75
M _{Ed} = 1/8* 39.56*5.50 ²	= 149.59 kNm	63.22	49.16

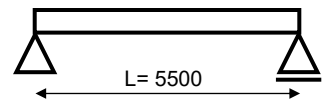

Profiel gegevens

Profiel = HEB220	(W _y = 736 *10 ³ mm ³ ,	I _y = 8091 *10 ⁴ mm ⁴)
Reductie χ _{LT} = 1.00		
Kwaliteitsklasse = S 235		
Elasticiteitsmodulus = 2.1*10 ⁵ N/mm ²		

Controle op buigsterkte

M _{Ed} = 149.59 kNm		
M _{Rd} = 736*10 ³ *235/10 ⁶	= 172.96 kNm	UC = 0.86

Controle op doorbuiging

w _G = 11.72 mm	Zeeg = 0 mm	
w _{inst} = 20.84 mm		
w _{bij} = 9.12 mm	< 0.002 * lengte = 11.00 mm	UC = 0.83
w _{fin} = 20.84 mm	< 0.004 * lengte = 22.00 mm	UC = 0.95

3.3.6 Ligger as 3 / B-C

q-1 blijvende belasting verdiepingsvloer_D200 eg ligger	6.15 * 5.25 0.43	= =	32.29 kN/m ¹ 0.43 kN/m ¹
		g _k totaal =	32.72 kN/m ¹
q-1 opgelegde belasting verdiepingsvloer_D200	5.00 * 5.25	=	26.25 kN/m ¹
		q _k totaal =	26.25 kN/m ¹

Belasting combinaties

q g _k = 32.72 kN/m ¹		ψ ₀ = 0.4
q q _k = 26.25 kN/m ¹		ψ ₁ = 0.7
		ψ ₂ = 0.6
q _{inst} = 32.72+26.25	= 58.97 kN/m ¹	
q _{freq,6.15} = 32.72+26.25*0.7	= 51.10 kN/m ¹	

$$q_{d,6.10a} = 1.35 \cdot 32.72 + 1.50 \cdot 26.25 \cdot 0.4 = 59.92 \text{ kN/m}^1$$

$$q_{d,6.10b} = 1.20 \cdot 32.72 + 1.50 \cdot 26.25 = 78.64 \text{ kN/m}^1$$

Mechanica schema

Lengte	=	2600 mm			
$R_{A,Ed}$	=	$1/2 \cdot 78.64 \cdot 2.60$	=	102.23 kN	g_k 42.54 q_k 34.13
$R_{B,Ed}$	=	$1/2 \cdot 78.64 \cdot 2.60$	=	102.23 kN	42.54 34.13
M_{Ed}	=	$1/8 \cdot 78.64 \cdot 2.60^2$	=	66.45 kNm	27.65 22.18

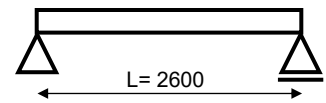

Profiel gegevens

Profiel	=	HEA200	($W_y = 389 \cdot 10^3 \text{ mm}^3$,	$I_y = 3692 \cdot 10^4 \text{ mm}^4$)
Reductie χ_{LT}	=	1.00		
Kwaliteitsklasse	=	S 235		
Elasticiteitsmodulus	=	$2.1 \cdot 10^5 \text{ N/mm}^2$		

Controle op buigsterkte

M_{Ed}	=	66.45 kNm			
M_{Rd}	=	$389 \cdot 10^3 \cdot 235 / 10^6$	=	91.41 kNm	UC = 0.73

Controle op doorbuiging

w_G	=	2.51 mm	Zeeg	=	0 mm	
w_{inst}	=	4.53 mm				
w_{bij}	=	2.01 mm	<	0.002	* lengte = 5.20 mm	UC = 0.39
w_{fin}	=	4.53 mm	<	0.004	* lengte = 10.40 mm	UC = 0.43

Controle oplegging

R_{Ed}	=	102.23 kN	Opleggen op bouwvilt		
oplegbreedte	=	200 mm			
opleglengte	=	200 mm			
σ_{Ed}	=	$102.23 \cdot 10^3 / (200 \cdot 200)$	=	2.56 N/mm ²	< 3.89 N/mm ² UC = 0.66

3.3.7 Ligger as 3 vergaderruimte - berging

q-1 blijvende belasting

verdiepingsvloer_D320	7.45 * 5.25	=	39.11 kN/m ¹
verdiepingsvloer_D200	6.15 * 2.60	=	15.99 kN/m ¹
eg ligger	0.43	=	0.43 kN/m ¹
g_k totaal		=	55.53 kN/m ¹

q-1 opgelegde belasting

verdiepingsvloer_D320	5.00 * 5.25	=	26.25 kN/m ¹
verdiepingsvloer_D200	5.00 * 2.60	=	13.00 kN/m ¹
q_k totaal		=	39.25 kN/m ¹

Belasting combinaties

q g_k	=	55.53 kN/m ¹	$\psi_0 = 0.4$
q q_k	=	39.25 kN/m ¹	$\psi_1 = 0.7$
			$\psi_2 = 0.6$

q_{inst}	=	55.53 + 39.25	=	94.78 kN/m ¹
$q_{freq,6.15}$	=	$55.53 + 39.25 \cdot 0.7$	=	83.01 kN/m ¹
$q_{d,6.10a}$	=	$1.35 \cdot 55.53 + 1.50 \cdot 39.25 \cdot 0.4$	=	98.52 kN/m ¹
$q_{d,6.10b}$	=	$1.20 \cdot 55.53 + 1.50 \cdot 39.25$	=	125.51 kN/m ¹

Mechanica schema

Lengte	=	2000 mm			
$R_{A,Ed}$	=	$1/2 \cdot 125.51 \cdot 2.00$	=	125.51 kN	g_k 55.53 q_k 39.25
$R_{B,Ed}$	=	$1/2 \cdot 125.51 \cdot 2.00$	=	125.51 kN	55.53 39.25
M_{Ed}	=	$1/8 \cdot 125.51 \cdot 2.00^2$	=	62.76 kNm	27.77 19.63

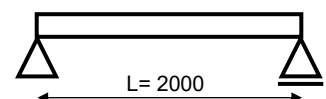

Profiel gegevens

Profiel = HEA200 ($W_y = 389 \cdot 10^3 \text{ mm}^3$, $I_y = 3692 \cdot 10^4 \text{ mm}^4$)
 Reductie χ_{LT} = 1.00
 Kwaliteitsklasse = S 235
 Elasticiteitsmodulus = $2.1 \cdot 10^5 \text{ N/mm}^2$

Controle op buigsterkte

$M_{Ed} = 62.76 \text{ kNm}$
 $M_{Rd} = 389 \cdot 10^3 \cdot 235 / 10^6 = 91.41 \text{ KNm}$ UC = 0.69

Controle op doorbuiging

$w_G = 1.49 \text{ mm}$ Zeeg = 0 mm
 $w_{inst} = 2.55 \text{ mm}$
 $w_{bij} = 1.05 \text{ mm}$ < 0.002 * lengte = 4.00 mm UC = 0.26
 $w_{fin} = 2.55 \text{ mm}$ < 0.004 * lengte = 8.00 mm UC = 0.32

Controle oplegging

$R_{Ed} = 125.51 \text{ kN}$ Opleggen op bouwvilt
 oplegbreedte = 200 mm
 opleglengte = 200 mm
 $\sigma_{Ed} = 125.51 \cdot 10^3 / (200 \cdot 200) = 3.14 \text{ N/mm}^2$ < 3.89 N/mm² UC = 0.81

3.3.8 Ligger as 4 tpv hal-gang

q-1 blijvende belasting
 verdiepingvloer_D200 $6.15 \cdot (2.60+1.10) = 22.76 \text{ kN/m}^1$
 eg ligger 0.43 $= 0.43 \text{ kN/m}^1$
 $g_k \text{ totaal} = 23.19 \text{ kN/m}^1$
 q-1 opgelegde belasting
 verdiepingvloer_D200 $5.00 \cdot (2.60+1.10) = 18.50 \text{ kN/m}^1$
 $q_k \text{ totaal} = 18.50 \text{ kN/m}^1$

Belasting combinaties

$q \ g_k = 23.19 \text{ kN/m}^1$ $\psi_0 = 0.4$
 $q \ q_k = 18.50 \text{ kN/m}^1$ $\psi_1 = 0.7$
 $\psi_2 = 0.6$
 $q_{inst} = 23.19 + 18.50 = 41.69 \text{ kN/m}^1$
 $q_{freq,6.15} = 23.19 + 18.50 \cdot 0.7 = 36.14 \text{ kN/m}^1$
 $q_{d,6.10a} = 1.35 \cdot 23.19 + 1.50 \cdot 18.50 \cdot 0.4 = 42.41 \text{ kN/m}^1$
 $q_{d,6.10b} = 1.20 \cdot 23.19 + 1.50 \cdot 18.50 = 55.58 \text{ kN/m}^1$

Mechanica schema

Lengte = 2000 mm
 $R_{A,Ed} = 1/2 \cdot 55.58 \cdot 2.00 = 55.58 \text{ kN}$ g_k 23.19 q_k 18.50
 $R_{B,Ed} = 1/2 \cdot 55.58 \cdot 2.00 = 55.58 \text{ kN}$ 23.19 18.50
 $M_{Ed} = 1/8 \cdot 55.58 \cdot 2.00^2 = 27.79 \text{ kNm}$ 11.60 9.25

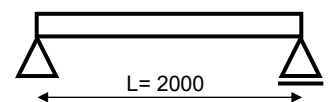

Profiel gegevens

Profiel = HEA200 ($W_y = 389 \cdot 10^3 \text{ mm}^3$, $I_y = 3692 \cdot 10^4 \text{ mm}^4$)
 Reductie χ_{LT} = 1.00
 Kwaliteitsklasse = S 235
 Elasticiteitsmodulus = $2.1 \cdot 10^5 \text{ N/mm}^2$

Controle op buigsterkte

$M_{Ed} = 27.79 \text{ kNm}$
 $M_{Rd} = 389 \cdot 10^3 \cdot 235 / 10^6 = 91.41 \text{ KNm}$ UC = 0.30

Controle op doorbuiging

$w_G = 0.62 \text{ mm}$ Zeeg = 0 mm
 $w_{inst} = 1.12 \text{ mm}$

W_{bij}	= 0.50 mm	< 0.002	* lengte = 4.00 mm	UC = 0.12
W_{fin}	= 1.12 mm	< 0.004	* lengte = 8.00 mm	UC = 0.14

Controle oplegging

R_{Ed}	= 55.58 kN	Opleggen op metselwerk		
oplegbreedte	= 200 mm			
opleglengte	= 150 mm			
σ_{Ed}	= $55.58 \cdot 10^3 / (200 \cdot 150)$	= 1.85 N/mm ²	< 2.50 N/mm ²	UC = 0.74

3.3.9 Ligger as 4 tpv berging-gang

q-1 blijvende belasting

dak_schuin_fundering	0.87 * 1.75	=	1.52 kN/m ¹
dak_plat_beton	5.00 * 1.10	=	5.50 kN/m ¹
verdiepingsvloer_D200	6.15 * (2.60+1.10)	=	22.76 kN/m ¹
metselwerk_D214mm	4.00 * 3.60	=	14.40 kN/m ¹
eg ligger	0.43	=	0.43 kN/m ¹
g_k totaal		=	44.61 kN/m ¹

q-1 opgelegde belasting

verdiepingsvloer_D200	5.00 * (2.60+1.10)	=	18.50 kN/m ¹
q_k totaal		=	18.50 kN/m ¹

Belasting combinaties

$q \ g_k$	= 44.61 kN/m ¹	$\psi_0 = 0.4$
$q \ q_k$	= 18.50 kN/m ¹	$\psi_1 = 0.7$
		$\psi_2 = 0.6$
q_{inst}	= 44.61+18.50	= 63.11 kN/m ¹
$q_{freq,6.15}$	= 44.61+18.50*0.7	= 57.56 kN/m ¹
$q_{d,6.10a}$	= 1.35*44.61+1.50*18.50*0.4	= 71.32 kN/m ¹
$q_{d,6.10b}$	= 1.20*44.61+1.50*18.50	= 81.28 kN/m ¹

Mechanica schema

Lengte	= 2000 mm		g_k	q_k
$R_{A,Ed}$	= $1/2 \cdot 81.28 \cdot 2.00$	= 81.28 kN	44.61	18.50
$R_{B,Ed}$	= $1/2 \cdot 81.28 \cdot 2.00$	= 81.28 kN	44.61	18.50
M_{Ed}	= $1/8 \cdot 81.28 \cdot 2.00^2$	= 40.64 kNm	22.31	9.25

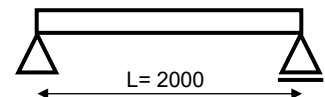

Profiel gegevens

Profiel	= HEA200	($W_y = 389 \cdot 10^3 \text{ mm}^3$,	$I_y = 3692 \cdot 10^4 \text{ mm}^4$)
Reductie χ_{LT}	= 1.00		
Kwaliteitsklasse	= S 235		
Elasticiteitsmodulus	= $2.1 \cdot 10^5 \text{ N/mm}^2$		

Controle op buigsterkte

M_{Ed}	= 40.64 kNm		
M_{Rd}	= $389 \cdot 10^3 \cdot 235 / 10^6$	= 91.41 kNm	UC = 0.44

Controle op doorbuiging

w_G	= 1.20 mm	Zeeg = 0 mm	
w_{inst}	= 1.70 mm		
w_{bij}	= 0.50 mm	< 0.002	* lengte = 4.00 mm UC = 0.12
w_{fin}	= 1.70 mm	< 0.004	* lengte = 8.00 mm UC = 0.21

Controle oplegging

R_{Ed}	= 81.28 kN	Opleggen op metselwerk	
oplegbreedte	= 200 mm		
opleglengte	= 200 mm		
σ_{Ed}	= $81.28 \cdot 10^3 / (200 \cdot 200)$	= 2.03 N/mm ²	< 2.50 N/mm ² UC = 0.81

3.3.10 Ligger as 4 tpv berging-gang

Belasting combinaties

q_{gk}	= 44.61 kN/m ¹		ψ_0	= 0.4
q_{qk}	= 18.50 kN/m ¹		ψ_1	= 0.7
			ψ_2	= 0.6
q_{inst}	= 44.61+18.50	= 63.11 kN/m ¹		
$q_{freq,6.15}$	= 44.61+18.50*0.7	= 57.56 kN/m ¹		
$q_{d,6.10a}$	= 1.35*44.61+1.50*18.50*0.4	= 71.32 kN/m ¹		
$q_{d,6.10b}$	= 1.20*44.61+1.50*18.50	= 81.28 kN/m ¹		

Mechanica schema

Lengte	= 1300 mm		g_k	q_k
$R_{A,Ed}$	= $1/2 * 81.28 * 1.30$	= 52.83 kN	29.00	12.03
$R_{B,Ed}$	= $1/2 * 81.28 * 1.30$	= 52.83 kN	29.00	12.03
M_{Ed}	= $1/8 * 81.28 * 1.30^2$	= 17.17 kNm	9.42	3.91

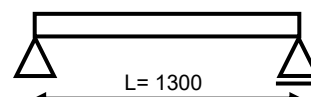

Profiel gegevens

Profiel	= HEA200	(W_y = 389 * 10 ³ mm ³ ,	I_y = 3692 * 10 ⁴ mm ⁴)
Reductie χ_{LT}	= 1.00		
Kwaliteitsklasse	= S 235		
Elasticiteitsmodulus	= 2.1 * 10 ⁵ N/mm ²		

Controle op buigsterkte

M_{Ed}	= 17.17 kNm		
M_{Rd}	= $389 * 10^3 * 235 / 10^6$	= 91.41 kNm	UC = 0.19

Controle op doorbuiging

w_G	= 0.21 mm	Zeeg	= 0 mm	
w_{inst}	= 0.30 mm			
w_{bij}	= 0.09 mm	< 0.002	* lengte = 2.60 mm	UC = 0.03
w_{fin}	= 0.30 mm	< 0.004	* lengte = 5.20 mm	UC = 0.06

Controle oplegging

R_{Ed}	= 52.83 kN	Opleggen op metselwerk	
oplegbreedte	= 200 mm		
opleglengte	= 150 mm		
σ_{Ed}	= $52.83 * 10^3 / (200 * 150)$	= 1.76 N/mm ²	< 2.50 N/mm ² UC = 0.70

3.3.11 Ligger as B / 4-5

q-1 blijvende belasting

dak_schuin_fundering	$0.87 * 5.25 * 0.5$	= 2.28 kN/m ¹
metselwerk_D214mm	$4.00 * 3.50$	= 14.00 kN/m ¹
g_k totaal		= 16.28 kN/m ¹

q-1 opgelegde belasting

sneeuw_aang_gem	$1.12 * 5.25 * 0.5$	= 2.94 kN/m ¹
q_k totaal		= 2.94 kN/m ¹

Belasting combinaties

q_{gk}	= 16.28 kN/m ¹		ψ_0	= 0.0
q_{qk}	= 2.94 kN/m ¹		ψ_1	= 0.2
			ψ_2	= 0.0
q_{inst}	= 16.28+2.94	= 19.22 kN/m ¹		
$q_{freq,6.15}$	= 16.28+2.94*0.2	= 16.87 kN/m ¹		
$q_{d,6.10a}$	= 1.35*16.28+1.50*2.94*0.0	= 21.98 kN/m ¹		
$q_{d,6.10b}$	= 1.20*16.28+1.50*2.94	= 23.95 kN/m ¹		

Mechanica schema

Lengte	=	2200 mm			g_k	q_k
$R_{A,Ed}$	=	$1/2 * 23.95 * 2.20$	=	26.35 kN	17.91	3.23
$R_{B,Ed}$	=	$1/2 * 23.95 * 2.20$	=	26.35 kN	17.91	3.23
M_{Ed}	=	$1/8 * 23.95 * 2.20^2$	=	14.49 kNm	9.85	1.78

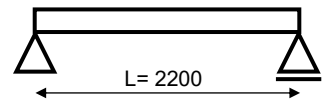

Profiel gegevens

Profiel	=	HEA140	($W_y =$	$155 * 10^3 \text{ mm}^3$,	$I_y =$	$1033 * 10^4 \text{ mm}^4$)
Reductie χ_{LT}	=	1.00				
Kwaliteitsklasse	=	S 235				
Elasticiteitsmodulus	=	$2.1 * 10^5 \text{ N/mm}^2$				

Controle op buigsterkte

M_{Ed}	=	14.49 kNm				
M_{Rd}	=	$155 * 10^3 * 235 / 10^6$	=	36.42 kNm		UC = 0.40

Controle op doorbuiging

w_G	=	2.29 mm	Zeeg	=	0 mm	
w_{inst}	=	2.70 mm				
w_{bij}	=	0.41 mm	<	0.002	* lengte = 4.40 mm	UC = 0.09
w_{fin}	=	2.70 mm	<	0.004	* lengte = 8.80 mm	UC = 0.31

Controle oplegging

R_{Ed}	=	26.35 kN	Opleggen op metselwerk			
oplegbreedte	=	140 mm				
opleglengte	=	120 mm				
σ_{Ed}	=	$26.35 * 10^3 / (140 * 120)$	=	1.57 N/mm ²	<	2.50 N/mm ² UC = 0.63

3.3.12 Ligger as 5

Algemeen

q-1 blijvende belasting

dak_plat_beton	$5.00 * 1.10$	=	5.50 kN/m ¹
dak_plat_hout	$0.90 * 1.40$	=	1.26 kN/m ¹
metselwerk_D120mm	$2.40 * 3.50$	=	8.40 kN/m ¹
verdiepingsvloer_D200	$6.15 * 1.10$	=	6.77 kN/m ¹
e.g. ligger	0.25	=	0.25 kN/m ¹
g_k totaal		=	22.18 kN/m ¹

q-1 opgelegde belasting

verdiepingsvloer_D200	$5.00 * 1.10$	=	5.50 kN/m ¹
q_k totaal		=	5.50 kN/m ¹

Belasting combinaties

q g_k	=	22.18 kN/m ¹	$\psi_0 = 0.4$	
q q_k	=	5.50 kN/m ¹	$\psi_1 = 0.7$	
			$\psi_2 = 0.6$	
q_{inst}	=	$22.18 + 5.50$	=	27.68 kN/m ¹
$q_{freq,6.15}$	=	$22.18 + 5.50 * 0.7$	=	26.03 kN/m ¹
$q_{d,6.10a}$	=	$1.35 * 22.18 + 1.50 * 5.50 * 0.4$	=	33.24 kN/m ¹
$q_{d,6.10b}$	=	$1.20 * 22.18 + 1.50 * 5.50$	=	34.87 kN/m ¹

Mechanica schema

Lengte	=	2000 mm			g_k	q_k
$R_{A,Ed}$	=	$1/2 * 34.87 * 2.00$	=	34.87 kN	22.18	5.50
$R_{B,Ed}$	=	$1/2 * 34.87 * 2.00$	=	34.87 kN	22.18	5.50
M_{Ed}	=	$1/8 * 34.87 * 2.00^2$	=	17.44 kNm	11.09	2.75

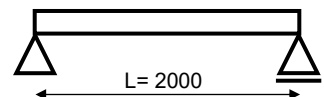

Profiel gegevens

Profiel	=	HEA140	($W_y =$	$155 * 10^3 \text{ mm}^3$,	$I_y =$	$1033 * 10^4 \text{ mm}^4$)
Reductie χ_{LT}	=	1.00				

Kwaliteitsklasse = S 235
 Elasticiteitsmodulus = $2.1 \cdot 10^5$ N/mm²

Controle op buigsterkte

$M_{Ed} = 17.44$ kNm
 $M_{Rd} = 155 \cdot 10^3 \cdot 235 / 10^6 = 36.42$ kNm UC = 0.48

Controle op doorbuiging

$w_G = 2.13$ mm Zeeg = 0 mm
 $w_{inst} = 2.66$ mm
 $w_{bij} = 0.53$ mm < 0.002 * lengte = 4.00 mm UC = 0.13
 $w_{fin} = 2.66$ mm < 0.004 * lengte = 8.00 mm UC = 0.33

Controle oplegging

$R_{Ed} = 34.87$ kN Opleggen op metselwerk
 oplegbreedte = 120 mm
 opleglengte = 200 mm
 $\sigma_{Ed} = 34.87 \cdot 10^3 / (120 \cdot 200) = 1.45$ N/mm² < 2.50 N/mm² UC = 0.58

Tpv as B

q-1 blijvende belasting
 dak_plat_beton $5.00 \cdot 1.10 = 5.50$ kN/m¹
 dak_plat_hout $0.90 \cdot 1.40 = 1.26$ kN/m¹
 metselwerk_D120mm $2.40 \cdot 3.50 = 8.40$ kN/m¹
 verdiepingsvloer_D200 $6.15 \cdot 1.10 = 6.77$ kN/m¹
 e.g. ligger 0.25 = 0.25 kN/m¹
 g_k totaal = 22.18 kN/m¹

q-1 opgelegde belasting
 verdiepingsvloer_D200 $5.00 \cdot 1.10 = 5.50$ kN/m¹
 q_k totaal = 5.50 kN/m¹

F-1 blijvende belasting
 uit_ligger_as_B 17.91 = 17.91 kN
 g_k totaal = 17.91 kN

F-1 opgelegde belasting
 uit_ligger_as_B 3.23 = 3.23 kN
 q_k totaal = 3.23 kN

Belasting combinaties

$q_{gk} = 22.18$ kN/m ¹	$F_{gk} = 17.91$ kN	$\psi_0 = 0.4$
$q_{qk} = 5.50$ kN/m ¹	$F_{qk} = 3.23$ kN	$\psi_1 = 0.5$
		$\psi_2 = 0.3$
$q_{inst} = 22.18 + 5.50 = 27.68$ kN/m ¹	$F_{inst} = 17.91 + 3.23 = 21.14$ kN	
$q_{freq,6.15} = 22.18 + 5.50 \cdot 0.5 = 24.93$ kN/m ¹	$F_{freq,6.15} = 17.91 + 3.23 \cdot 0.5 = 19.53$ kN	
$q_{d,6.10a} = 1.35 \cdot 22.18 + 1.50 \cdot 5.50 \cdot 0.4 = 33.24$ kN/m ¹	$F_{d,6.10a} = 1.35 \cdot 17.91 + 1.50 \cdot 3.23 \cdot 0.4 = 26.12$ kN	
$q_{d,6.10b} = 1.20 \cdot 22.18 + 1.50 \cdot 5.50 = 34.87$ kN/m ¹	$F_{d,6.10b} = 1.20 \cdot 17.91 + 1.50 \cdot 3.23 = 26.34$ kN	

Mechanica schema

Lengte = 2000 mm x = 500 mm
 $R_{A,Ed} = 1/2 \cdot 34.87 \cdot 2.00 + 0.75 \cdot 26.34 = 54.63$ kN g_k 35.61 q_k 7.92
 $R_{B,Ed} = 1/2 \cdot 34.87 \cdot 2.00 + 0.25 \cdot 26.34 = 41.46$ kN 26.66 6.31
 $M_{Ed} = -1/2 \cdot 34.87 \cdot 1.19^2 + 41.46 \cdot 1.19 = 24.65$ kNm 16.02 3.61

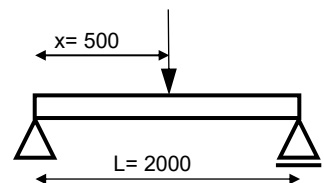

Profiel gegevens

Profiel = HEA140 ($W_y = 155 \cdot 10^3$ mm³, $I_y = 1033 \cdot 10^4$ mm⁴)
 Reductie $\chi_{LT} = 1.00$
 Kwaliteitsklasse = S 235
 Elasticiteitsmodulus = $2.1 \cdot 10^5$ N/mm²

Controle op buigsterkte

$M_{Ed} = 24.65$ kNm

$$M_{Rd} = 155 \cdot 10^3 \cdot 235 / 10^6 = 36.42 \text{ KNm} \quad UC = 0.68$$

Controle op doorbuiging

$$\begin{aligned} W_G &= 3.09 \text{ mm} & Z_{eeg} &= 0 \text{ mm} \\ W_{inst} &= 3.79 \text{ mm} \\ W_{bij} &= 0.70 \text{ mm} & < 0.002 & * \text{ lengte} = 4.00 \text{ mm} & UC = 0.18 \\ W_{fin} &= 3.79 \text{ mm} & < 0.004 & * \text{ lengte} = 8.00 \text{ mm} & UC = 0.47 \end{aligned}$$

Controle oplegging

$$\begin{aligned} R_{Ed} &= 54.63 \text{ kN} & \text{Opleggen op metselwerk} \\ \text{oplegbreedte} &= 120 \text{ mm} \\ \text{opleglengte} &= 200 \text{ mm} \\ \sigma_{Ed} &= 54.63 \cdot 10^3 / (120 \cdot 200) = 2.28 \text{ N/mm}^2 < 2.50 \text{ N/mm}^2 & UC = 0.91 \end{aligned}$$

3.4 Gevelkolommen

Kolom as 2

F1v	op 3.00 m		
e.g.uit_verd_as2		87.5	= 87.50 kN
v.b.uit_verd_as2		68.9	= 68.90 kN
Me.g.uit_verd_as2		$87.5 * 0.14$	= 12.25 kNm
Mv.b.uit_verd_as2		$68.9 * 0.14$	= 9.65 kNm
F2v	op 5.50 m		
e.g.uit_randligger		$4.52 * 5.25$	= 23.73 kN
v.b.uit_randligger		$1.07 * 5.25$	= 5.62 kN
F2h	op 5.50 m		
e.g.uit_randligger		$1.44 * 5.25$	= 7.56 kN
v.b.uit_randligger		$0.85 * 5.25$	= 4.46 kN

Kolom as D

F1v	op 3.00 m		
e.g.uit_verd_as1		$126.70 * 2$	= 253.40 kN
v.b.uit_verd_as1		$73.83 * 2$	= 147.66 kN
F2v	op 3.75 m		
e.g.uit_randligger		$4.52 * 5.625$	= 25.43 kN
v.b.uit_randligger		$1.07 * 5.625$	= 6.02 kN
F2h	op 3.75 m		
e.g.uit_randligger		$1.44 * 5.625$	= 8.10 kN
v.b.uit_randligger		$0.85 * 5.625$	= 4.78 kN

Project.....: 10745
 Onderdeel....: Gevelkolommen
 Dimensies....: kN;m;rad (tenzij anders aangegeven)
 Bestand.....: N:\Order\10000\10700\10745\berekeningen en
 schetsen\gevelkolommen.rww

Belastingbreedte.: 1.000
 Rekenmodel.....: 1e-orde-elastisch.
 Theorie voor de bepaling van de krachtsverdeling:
 Geometrisch lineair.
 Fysisch lineair.

Gunstige werking van de permanente belasting wordt automatisch verwerkt.

Toegepaste normen volgens Eurocode met Nederlandse NB

Belastingen	NEN-EN 1990:2002	C2:2010,A1:2019	NB:2019(nl)
	NEN-EN 1991-1-1:2002	C1/C11:2019	NB:2019(nl)
Staal	NEN-EN 1993-1-1:2006	C2:2011,A1:2016	NB:2016(nl)

GEOMETRIE

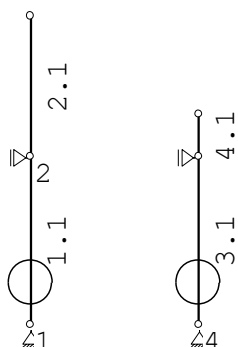

MATERIALEN

Mt	Kwaliteit	E-modulus[N/mm2]	S.G.	Pois.	Uitz. coëff
1	S235	210000	78.5	0.30	1.2000e-05

PROFIELEN [mm]

Prof.	Omschrijving	Materiaal	Oppervlak	Traagheid	Vormf.
1	B273/12.5	1:S235	1.0230e+04	8.6974e+07	0.00

PROFIELEN vervolg [mm]

Prof.	Staaftype	Breedte	Hoogte	e	Type	b1	h1	b2	h2
1	0:Normaal	273	273	136.5					

Project.....: 10745
 Onderdeel....: Gevelkolommen

PROFIELVORMEN [mm]

1 B273/12.5



KNOPEN

Knoop	X	Z	Knoop	X	Z
1	0.000	0.000	6	3.000	3.750
2	0.000	3.000			
3	0.000	5.500			
4	3.000	0.000			
5	3.000	3.000			

STAVEN

St.	ki	kj	Profiel	Aansl.i	Aansl.j	Lengte	Opm.
1	1	2	1:B273/12.5	NDM	NDM	3.000	
2	2	3	1:B273/12.5	NDM	NDM	2.500	
3	4	5	1:B273/12.5	NDM	NDM	3.000	
4	5	6	1:B273/12.5	NDM	NDM	0.750	

VASTE STEUNPUNTEN

Nr.	knoop	Kode	XZR	1=vast	0=vrij	Hoek
1	1	110				0.00
2	2	100				0.00
3	4	110				0.00
4	5	100				0.00

BELASTINGGENERATIE ALGEMEEN.

Betrouwbaarheidsklasse.....:	2	Referentieperiode.....:	50
Gebouwdiepte.....:	0.00	Gebouwhoogte.....:	5.50
Niveau aansl.terrein.....:	0.00	E.g. scheid.w. [kN/m2]:	0.00

STAAFTYPEN

Type	staven
1:Vloer.	: 1-4

Project.....: 10745
 Onderdeel....: Gevelkolommen

LASTVELDEN

Veranderlijke belastingen door personen

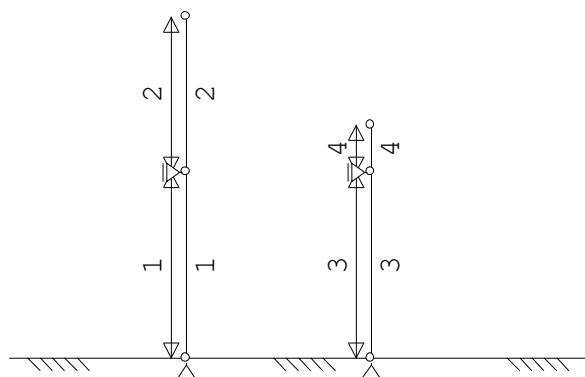

LASTVELDEN

Nr	StAAF	Tabel	Klasse-Gebruiksfunctie	Verd.	q _k	Q _k	F _t / F _{t0}
1	1-1	6.2	C5-Grote mensenmassa's	0	-5.00	-7.00	1.00
2	2-2	6.2	C5-Grote mensenmassa's	0	-5.00	-7.00	1.00
3	3-3	6.2	C5-Grote mensenmassa's	0	-5.00	-7.00	1.00
4	4-4	6.2	C5-Grote mensenmassa's	0	-5.00	-7.00	1.00

BELASTINGGEVALLEN

B.G.	Omschrijving	Type
1	Permanente belasting EGZ=-1.00	1
g*	2 Ver. bel. pers. ed. (q _k)	2

g = gegeneerd belastinggeval

* = belastinggeval bevat 1 of meer handmatig toegevoegde en/of gewijzigde lasten

BELASTINGEN

B.G:1 Permanente belasting

Eigen gewicht van alle staven is meegenomen in berekening. Richting:↓

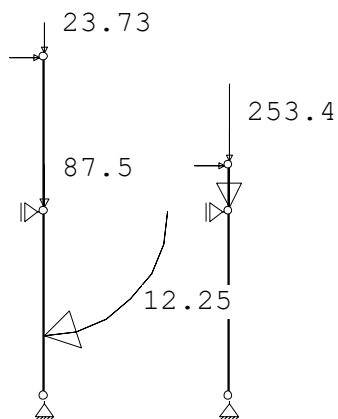

Project.....: 10745
 Onderdeel....: Gevelkolommen

KNOOPBELASTINGEN

B.G:1 Permanente belasting

Last	Knoop	Richting	waarde	Ψ_0	Ψ_1	Ψ_2
1	2	Z	-87.500			
2	3	Z	-23.730			
3	3	X	7.560			
4	5	Z	-253.400			
5	6	Z	-25.430			
6	6	X	8.100			
7	2	Rotatie Y	12.250			

BELASTINGEN

B.G:2 Ver. bel. pers. ed. (q_k)

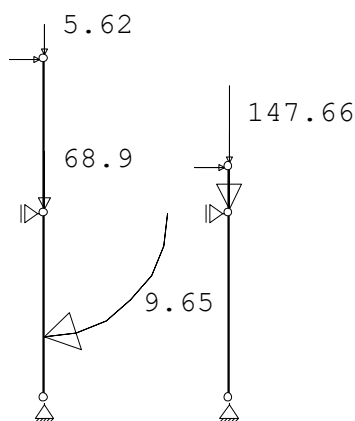

KNOOPBELASTINGEN

B.G:2 Ver. bel. pers. ed. (q_k)

Last	Knoop	Richting	waarde	Ψ_0	Ψ_1	Ψ_2	Opm.
1	2	Z	-68.900	0.40	0.70	0.60	*
2	3	Z	-5.620	0.40	0.70	0.60	*
3	3	X	4.460	0.40	0.70	0.60	*
4	5	Z	-147.660	0.40	0.70	0.60	*
5	6	Z	-6.020	0.40	0.70	0.60	*
6	6	X	4.780	0.40	0.70	0.60	*
7	2	Rotatie Y	9.650	0.40	0.70	0.60	*

Opmerkingen

[*] Deze belasting is handmatig toegevoegd of gewijzigd.

REACTIES

Kn.	B.G.	X	Z	M
1	1	10.38	115.65	
1	2	6.93	74.52	
2	1	-17.94		
2	2	-11.39		
4	1	2.02	281.84	
4	2	1.19	153.68	
5	1	-10.13		
5	2	-5.97		

Project.....: 10745
 Onderdeel....: Gevelkolommen

BELASTINGCOMBINATIES

BC Type	BG Gen.	Factor	BG Gen.	Factor	BG Gen.	Factor	BG Gen.	Factor
1 Fund.	1 Perm	1.35						
2 Fund.	1 Perm	0.90						
3 Fund.	1 Perm	1.35	2 psi0	1.50				
4 Fund.	1 Perm	1.20	2 Extr	1.50				
5 Fund.	1 Perm	0.90	2 Extr	1.50				
6 Fund.	1 Perm	0.90	2 psi0	1.50				
7 Kar.	1 Perm	1.00	2 Extr	1.00				
8 Quas.	1 Perm	1.00						
9 Quas.	1 Perm	1.00	2 psi2	1.00				
10 Freq.	1 Perm	1.00						
11 Freq.	1 Perm	1.00	2 psi1	1.00				
12 Blij.	1 Perm	1.00						

GUNSTIGE WERKING PERMANENTE BELASTINGEN

BC Staven met gunstige werking
1 Geen
2 Alle staven de factor:0.90
3 Geen
4 Geen
5 Alle staven de factor:0.90
6 Alle staven de factor:0.90

OMHULLENDE VAN DE FUNDAMENTELE COMBINATIES

MOMENTEN

Fundamentele combinatie

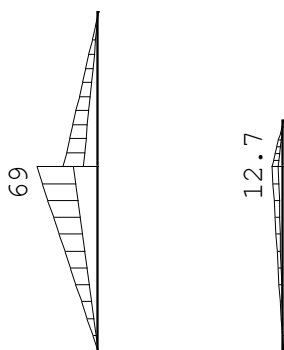

Project.....: 10745
 Onderdeel....: Gevelkolommen

DWARSKRACHTEN

Fundamentele combinatie

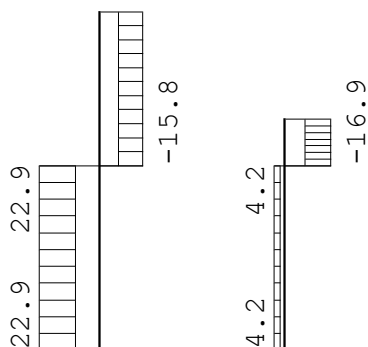

NORMAALKRACHTEN

Fundamentele combinatie

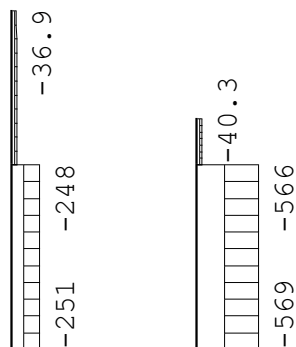

STAAFKRACHTEN

Fundamentele combinatie

St.	Kn.	Pos.	NXi/NXj		DZi/DZj				MYi/MYj					
			Min	BC	Max	BC	Min	BC	Max	BC	Min	BC	Max	BC
1	1		-250.56	4	-104.08	2	9.34	2	22.86	4	0.00	2	0.00	4
1	2		-247.67	4	-101.91	2	9.34	2	22.86	4	28.03	2	68.58	4
2	2		-39.32	4	-23.16	2	-15.76	4	-6.80	2	17.01	2	39.41	4
2	3		-36.91	4	-21.36	2	-15.76	4	-6.80	2	0.00	2	0.00	4
3	4		-568.73	4	-253.66	2	1.82	2	4.22	4	0.00	2	0.00	4
3	5		-565.84	4	-251.49	2	1.82	2	4.22	4	5.47	2	12.67	4
4	5		-40.27	4	-23.43	2	-16.89	4	-7.29	2	5.47	2	12.67	4
4	6		-39.55	4	-22.89	2	-16.89	4	-7.29	2	0.00	2	0.00	4

REACTIES

Fundamentele combinatie

Kn.	X-min	X-max	Z-min	Z-max	M-min	M-max
1	9.34	22.86	104.08	250.56		
2	-38.62	-16.15				
4	1.82	4.22	253.66	568.73		
5	-21.11	-9.11				

Project.....: 10745
 Onderdeel....: Gevelkolommen

OMHULLENDE VAN DE KARAKTERISTIEKE COMBINATIES

VERPLAATSINGEN [mm] Karakteristieke combinatie

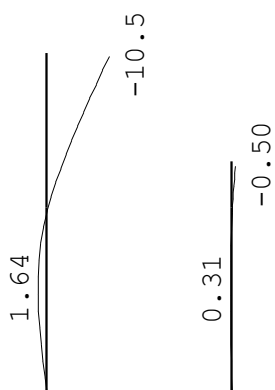

STAALPROFIELEN - ALGEMENE GEGEVENS

Stabiliteit: Classificatie gehele constructie: Geschoord
 Doorbuiging en verplaatsing:
 Aantal bouwlagen: 1
 Gebouwtipe: Overig
 Toel. horiz. verplaatsing gehele gebouw: h/250
 Kleinste gevelhoogte [m]: 0.0

PROFIEL/MATERIAAL

P/M nr.	Profielnaam	Vloei-sp. [N/mm ²]	Productie methode	Min. drsn. klasse
1	B273/12.5	235	Warmgewalst	1

Partiële veiligheidsfactoren:
 Gamma M;0 : 1.00 Gamma M;1 : 1.00
 Gamma M;fi;mech : 1.00 Gamma M;fi;therm : 1.00

KNIKSTABILITEIT

Staaft	l _{sys} [m]	Classif. y sterke as	l _{knik,y} [m]	Extra		l _{knik,z} [m]	Extra	
				aanp. y [kN]	Classif. z zwakke as		aanp. z [kN]	
1	3.000	Geschoord	3.000	0.0	Geschoord	3.000	0.0	
2	2.500	Geschoord	2.500	0.0	Geschoord	2.500	0.0	
3	3.000	Geschoord	3.000	0.0	Geschoord	3.000	0.0	
4	0.750	Geschoord	0.750	0.0	Geschoord	0.750	0.0	

KIPSTABILITEIT

Staaft	Plts. aangr.	l gaffel [m]	Kipsteunafstanden [m]
1	1.0*h	boven:	3.00 3.000
		onder:	3.000
2	1.0*h	boven:	2.50 2.500
		onder:	2.500
3	1.0*h	boven:	3.00 3.000
		onder:	3.000

Project.....: 10745
 Onderdeel....: Gevelkolommen

KIPSTABILITEIT

Staafl	Plts. aangr.	l gaffel	Kipsteunafstanden
		[m]	[m]
4	1.0*h	boven: 0.75	0.750
		onder: 0.750	0.750

TOETSING SPANNINGEN

Staafl nr.	P/M	BC	Sit	Kl	Plaats	Norm	Artikel	Formule	Hoogste toetsing U.C. [N/mm ²]	Opm.
1	1	4	1	1	Einde	EN3-1-1	6.2.10	(6.45+6.31y)	0.351	83
2	1	4	1	1	Begin	EN3-1-1	6.2.10	(6.45+6.31y)	0.198	46
3	1	4	1	1	Staafl	EN3-1-1	6.3.3	(6.61)	0.284	67
4	1	4	1	1	Begin	EN3-1-1	6.2.10	(6.45+6.31y)	0.064	15

TOETSING HORIZONTALE VERPLAATSING

Staafl	BC	Sit	Lengte [m]	u _{e i n d} [mm]	Toelaatbaar [mm]	Maatgevend [h/]
1	7	1	3.000	1.6	12.0	250 doorbuiging
2	7	1	2.500	-10.5	10.0	250 scheefstand
3	7	1	3.000	0.3	12.0	250 doorbuiging
4	7	1	0.750	-0.5	3.0	250 scheefstand

TOETSING HOR. VERPLAATSING GLOBAAL

Er is een maximale horizontale verplaatsing van 0.0105 [m] gevonden bij knoop 3 en combinatie 7; belastingsituatie 1 (combinatietype 2). Bij een hoogte van 5.500 [m] levert dit h / 522 (toel.: h / 250).

Overschrijding verplaatsing acceptabel door controle met meest ongunstigste combinatie in extreem belastingsgeval.

Brandcontrole

Kolom as 2

F1v op 3.00 m
e.g.uit_verd_as2 87.5 = 87.50 kN
v.b.uit_verd_as2 68.9 *0.6 = 41.34 kN

F2v op 5.50 m
e.g.uit_randligger 4.52 * 5.25 = 23.73 kN
v.b.uit_randligger 1.07 * 5.25 *0.2 = 1.12 kN

F2h op 5.50 m
e.g.uit_randligger 1.44 * 5.25 = 7.56 kN
v.b.uit_randligger 0.85 * 5.25 *0.2 = 0.89 kN

Kolom as D

F1v op 3.00 m
e.g.uit_verd_as1 126.70 * 2 = 253.40 kN
v.b.uit_verd_as1 73.83 * 2 *0.6 = 88.60 kN

F2v op 3.75 m
e.g.uit_randligger 4.52 * 5.625 = 25.43 kN
v.b.uit_randligger 1.07 * 5.625 *0.2 = 1.20 kN

F2h op 3.75 m
e.g.uit_randligger 1.44 * 5.625 = 8.10 kN
v.b.uit_randligger 0.85 * 5.625 *0.2 = 0.96 kN

Project.....: 10745
 Onderdeel....: Gevelkolommen
 Dimensies....: kN;m;rad (tenzij anders aangegeven)
 Bestand.....: N:\Order\10000\10700\10745\berekeningen en
 schetsen\gevelkolommen incl brandcontrole.rww

Belastingbreedte.: 1.000
 Rekenmodel.....: 1e-orde-elastisch.
 Theorie voor de bepaling van de krachtsverdeling:
 Geometrisch lineair.
 Fysisch lineair.

Gunstige werking van de permanente belasting wordt automatisch verwerkt.

Toegepaste normen volgens Eurocode met Nederlandse NB

Belastingen	NEN-EN 1990:2002	C2:2010,A1:2019	NB:2019(nl)
	NEN-EN 1991-1-1:2002	C1/C11:2019	NB:2019(nl)
Staal	NEN-EN 1993-1-1:2006	C2:2011,A1:2016	NB:2016(nl)

GEOMETRIE

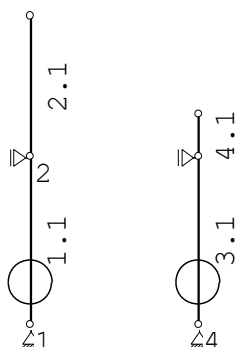

MATERIALEN

Mt	Kwaliteit	E-modulus[N/mm2]	S.G.	Pois.	Uitz. coëff
1	S235	210000	78.5	0.30	1.2000e-05

PROFIELEN [mm]

Prof.	Omschrijving	Materiaal	Oppervlak	Traagheid	Vormf.
1	B273/12.5	1:S235	1.0230e+04	8.6974e+07	0.00

PROFIELEN vervolg [mm]

Prof.	Staaftype	Breedte	Hoogte	e	Type	b1	h1	b2	h2
1	0:Normaal	273	273	136.5					

Project.....: 10745
 Onderdeel....: Gevelkolommen

PROFIELVORMEN [mm]

1 B273/12.5



KNOPEN

Knoop	X	Z	Knoop	X	Z
1	0.000	0.000	6	3.000	3.750
2	0.000	3.000			
3	0.000	5.500			
4	3.000	0.000			
5	3.000	3.000			

STAVEN

St.	ki	kj	Profiel	Aansl.i	Aansl.j	Lengte	Opm.
1	1	2	1:B273/12.5	NDM	NDM	3.000	
2	2	3	1:B273/12.5	NDM	NDM	2.500	
3	4	5	1:B273/12.5	NDM	NDM	3.000	
4	5	6	1:B273/12.5	NDM	NDM	0.750	

VASTE STEUNPUNTEN

Nr.	knoop	Kode	XZR	l=vast	0=vrij	Hoek
1	1	110				0.00
2	2	100				0.00
3	4	110				0.00
4	5	100				0.00

BELASTINGGEVALLEN

B.G.	Omschrijving	EGZ	Type
1	Permanente belasting	EGZ=-1.00	1
2	Ver. bel. pers. ed. (q_k)		2

BELASTINGEN

B.G:1 Permanente belasting

Eigen gewicht van alle staven is meegenomen in berekening. Richting:↓

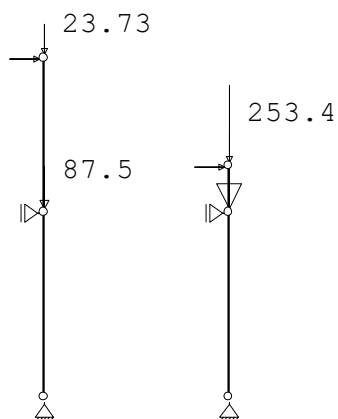

Project.....: 10745
 Onderdeel....: Gevelkolommen

KNOOPBELASTINGEN

B.G:1 Permanente belasting

Last	Knoop	Richting	waarde	Ψ_0	Ψ_1	Ψ_2
1	2	Z	-87.500			
2	3	Z	-23.730			
3	3	X	7.560			
4	5	Z	-253.400			
5	6	Z	-25.430			
6	6	X	8.100			

BELASTINGEN

B.G:2 Ver. bel. pers. ed. (q_k)

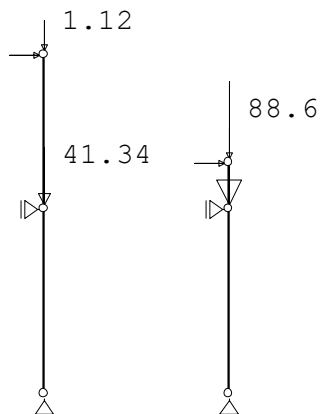

KNOOPBELASTINGEN

B.G:2 Ver. bel. pers. ed. (q_k)

Last	Knoop	Richting	waarde	Ψ_0	Ψ_1	Ψ_2
1	2	Z	-41.340	1.00	1.00	1.00
2	3	Z	-1.120	1.00	1.00	1.00
3	3	X	0.890	1.00	1.00	1.00
4	5	Z	-88.600	1.00	1.00	1.00
5	6	Z	-1.200	1.00	1.00	1.00
6	6	X	0.960	1.00	1.00	1.00

REACTIES

Kn.	B.G.	X	Z	M
1	1	6.30	115.65	
1	2	0.74	42.46	
2	1	-13.86		
2	2	-1.63		
4	1	2.02	281.84	
4	2	0.24	89.80	
5	1	-10.13		
5	2	-1.20		

Project.....: 10745
 Onderdeel....: Gevelkolommen

BELASTINGCOMBINATIES

BC Type	BG Gen.	Factor	BG Gen.	Factor	BG Gen.	Factor	BG Gen.	Factor
1 Fund.	1 Perm	1.00	2 Extr	1.00				

GUNSTIGE WERKING PERMANENTE BELASTINGEN

BC Staven met gunstige werking
1 Alle staven de factor:1.00

OMHULLENDE VAN DE FUNDAMENTELE COMBINATIES

MOMENTEN

Fundamentele combinatie

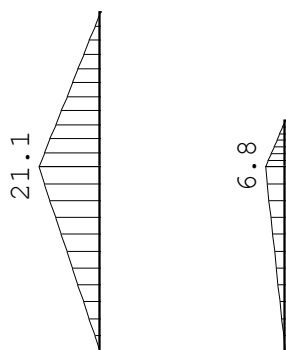

DWASKRACHTEN

Fundamentele combinatie

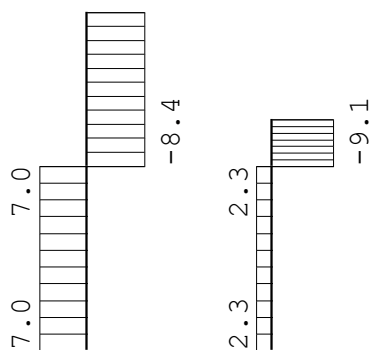

Project.....: 10745
 Onderdeel....: Gevelkolommen

NORMAALKRACHTEN

Fundamentele combinatie

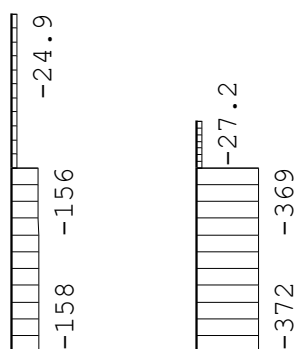

STAAFKRACHTEN

Fundamentele combinatie

St.	Kn.	Pos.	NXi/NXj	DZi/DZj	MYi/MYj
1	1		-158.11	7.04	0.00
1	2		-155.70	7.04	21.12
2	2		-26.86	-8.45	21.12
2	3		-24.85	-8.45	0.00
3	4		-371.64	2.26	0.00
3	5		-369.23	2.26	6.79
4	5		-27.23	-9.06	6.79
4	6		-26.63	-9.06	0.00

REACTIES

Fundamentele combinatie

Kn.	X	Z	M
1	7.04	158.11	
2	-15.49		
4	2.26	371.64	
5	-11.32		

Kolom as 2

Excentriciteit = $21.1 / 158.11 = 0.133 \text{ m}$ (uit TS-Raamwerken)

PotFire - V3.2.3 (EN 1994-1-2 + French National Annex)

Section
 Type of section: Circular
 Size of steel section
 Diameter: 273 mm
 Thickness: 12.5 mm

Material characteristics
 Yield strength of structural steel: 235 MPa
 Compressive strength of concrete (cylinder at 28 days): 20 MPa
 Yield strength of rebars: 500 MPa

Fire calculation Room temperature calculation

Rebars
 By number of rebars By %
 Number of rebars: 4 (vertical), 16 (horizontal) mm
 Axis distance of rebars: 30 mm
 Equal to (As/(Ac+As)): 1.665 %

Effective length
 Length: 1.5 m

Eccentricity of the load
 Eccentricity: 133 mm

Calculation of
 Ultimate load
 Standard fire resistance duration: 60 min

Partial safety factors
 Structural steel factor: 1
 Concrete factor: 1
 Reinforcing steel factor: 1

Result
 Non-dimensional slenderness: 0.205
 Ultimate load: 255 kN

Kolom as D

Excentriciteit = $6.8 / 371.64 = 0.049 \text{ m}$ (uit TS-Raamwerken)

PotFire - V3.2.3 (EN 1994-1-2 + French National Annex)

Section
 Type of section: Circular
 Size of steel section
 Diameter: 273 mm
 Thickness: 12.5 mm

Material characteristics
 Yield strength of structural steel: 235 MPa
 Compressive strength of concrete (cylinder at 28 days): 20 MPa
 Yield strength of rebars: 500 MPa

Fire calculation Room temperature calculation

Rebars
 By number of rebars By %
 Number of rebars: 4 (vertical), 16 (horizontal) mm
 Axis distance of rebars: 30 mm
 Equal to (As/(Ac+As)): 1.665 %

Effective length
 Length: 1.5 m

Eccentricity of the load
 Eccentricity: 49 mm

Calculation of
 Ultimate load
 Standard fire resistance duration: 60 min

Partial safety factors
 Structural steel factor: 1
 Concrete factor: 1
 Reinforcing steel factor: 1

Result
 Non-dimensional slenderness: 0.205
 Ultimate load: 601 kN

3.5 Tussenkolom

Maatgevend tussenkolom as B/2

F1v op 6.40 m

e.g.uit_dak_asB	23.77	= 23.77 kN
dak_schuin_fundering	$0.87 * 5.25 * 0.5 * 7.88$	= 18.00 kN

Totaal = 41.77 kN

Meg = $(41.77 - 18.00) * 0.14 = 3.33$ kNm

v.b.uit_dak_asB	8.74	= 8.74 kN
sneeuw_aang_gem	$1.12 * 5.25 * 0.5 * 7.88$	= 23.17 kN

Totaal = 31.91 kN

Mvb = $(31.91 - 8.74) * 0.14 = 3.24$ kNm

F2v op 3.00 m

e.g.uit_as2/A-B	87.5	= 87.50 kN
e.g.uit_as2/B-C	46.0	= 46.00 kN
		= 133.50 kN

Meg = $(133.5 - 46.00) * 0.14 = 12.25$ kNm

v.b.uit_as2/A-B	68.9	= 68.90 kN
v.b.uit_as2/B-C	33.75	= 33.75 kN
		= 102.65 kN

Mvb = $(102.65 - 33.75) * 0.14 = 9.65$ kNm

Project.....: 10745
 Onderdeel....: tussenkolom
 Dimensies....: kN;m;rad (tenzij anders aangegeven)
 Bestand.....: N:\Order\10000\10700\10745\berekeningen en
 schetsen\tussenkolom.rww

Belastingbreedte.: 1.000
 Rekenmodel.....: 1e-orde-elastisch.
 Theorie voor de bepaling van de krachtsverdeling:
 Geometrisch lineair.
 Fysisch lineair.

Gunstige werking van de permanente belasting wordt automatisch verwerkt.

Toegepaste normen volgens Eurocode met Nederlandse NB

Belastingen	NEN-EN 1990:2002	C2:2010,A1:2019	NB:2019(nl)
	NEN-EN 1991-1-1:2002	C1/C11:2019	NB:2019(nl)
Staal	NEN-EN 1993-1-1:2006	C2:2011,A1:2016	NB:2016(nl)

GEOMETRIE

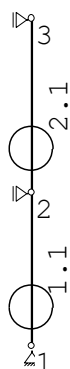

MATERIALEN

Mt	Kwaliteit	E-modulus[N/mm2]	S.G.	Pois.	Uitz. coëff
1	S235	210000	78.5	0.30	1.2000e-05

PROFIELEN [mm]

Prof.	Omschrijving	Materiaal	Oppervlak	Traagheid	Vormf.
1	B273/6.3	1:S235	5.2785e+03	4.6958e+07	0.00

PROFIELEN vervolg [mm]

Prof.	Staaftype	Breedte	Hoogte	e	Type	b1	h1	b2	h2
1	0:Normaal	273	273	136.5					

Project.....: 10745
 Onderdeel....: tussenkolom

PROFIELVORMEN [mm]

1 B273/6.3



KNOPEN

Knoop	X	Z
1	0.000	0.000
2	0.000	3.000
3	0.000	6.400

STAVEN

St.	ki	kj	Profiel	Aansl.i	Aansl.j	Lengte	Opm.
1	1	2	1:B273/6.3	NDM	NDM	3.000	
2	2	3	1:B273/6.3	NDM	NDM	3.400	

VASTE STEUNPUNTEN

Nr.	knoop	Kode	XZR 1=vast 0=vrij	Hoek
1	1	110		0.00
2	2	100		0.00
3	3	100		0.00

BELASTINGGEVALLEN

B.G.	Omschrijving	EGZ	Type
1	Permanente belasting	--1.00	1
2	Ver. bel. pers. ed. (q_k)		2

BELASTINGEN

B.G:1 Permanente belasting

Eigen gewicht van alle staven is meegenomen in berekening. Richting:↓

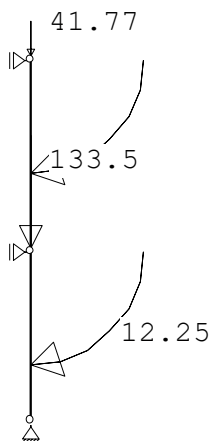

Project.....: 10745
 Onderdeel....: tussenkolom

KNOOPBELASTINGEN

B.G:1 Permanente belasting

Last	Knoop	Richting	waarde	Ψ_0	Ψ_1	Ψ_2
1	2	Z	-133.500			
2	3	Z	-41.770			
3	2	Rotatie Y	12.250			
4	3	Rotatie Y	3.330			

BELASTINGEN

B.G:2 Ver. bel. pers. ed. (q_k)

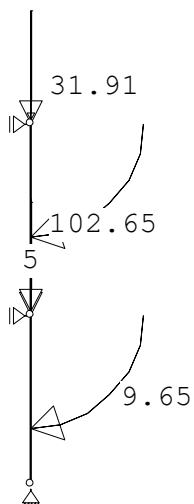

KNOOPBELASTINGEN

B.G:2 Ver. bel. pers. ed. (q_k)

Last	Knoop	Richting	waarde	Ψ_0	Ψ_1	Ψ_2
1	2	Z	-102.650	0.40	0.70	0.60
2	3	Z	-31.910	0.40	0.70	0.60
3	2	Rotatie Y	9.650	0.40	0.70	0.60
4	3	Rotatie Y	3.240	0.40	0.70	0.60

STAAFBELASTINGEN

B.G:2 Ver. bel. pers. ed. (q_k)

Staat	Type	q1/p/m	q2	A	B	Ψ_0	Ψ_1	Ψ_2
1	3:QZgeProj.	-5.00	-5.00	0.000	0.000	0.40	0.70	0.60
2	3:QZgeProj.	-5.00	-5.00	0.000	0.000	0.40	0.70	0.60

REACTIES

Kn.	B.G.	X	Z	M
1	1	1.87	177.92	
1	2	1.42	134.56	
2	1	1.05		
2	2	1.11		
3	1	-2.93		
3	2	-2.54		

Project.....: 10745
 Onderdeel....: tussenkolom

BELASTINGCOMBINATIES

BC Type	BG Gen.	Factor	BG Gen.	Factor	BG Gen.	Factor	BG Gen.	Factor
1 Fund.	1 Perm	1.35						
2 Fund.	1 Perm	0.90						
3 Fund.	1 Perm	1.35	2 psi0	1.50				
4 Fund.	1 Perm	1.20	2 Extr	1.50				
5 Fund.	1 Perm	0.90	2 Extr	1.50				
6 Fund.	1 Perm	0.90	2 psi0	1.50				
7 Kar.	1 Perm	1.00	2 Extr	1.00				
8 Quas.	1 Perm	1.00						
9 Quas.	1 Perm	1.00	2 psi2	1.00				
10 Freq.	1 Perm	1.00						
11 Freq.	1 Perm	1.00	2 psi1	1.00				
12 Blij.	1 Perm	1.00						

GUNSTIGE WERKING PERMANENTE BELASTINGEN

BC Staven met gunstige werking
1 Geen
2 Alle staven de factor:0.90
3 Geen
4 Geen
5 Alle staven de factor:0.90
6 Alle staven de factor:0.90

OMHULLENDE VAN DE FUNDAMENTELE COMBINATIES

MOMENTEN

Fundamentele combinatie

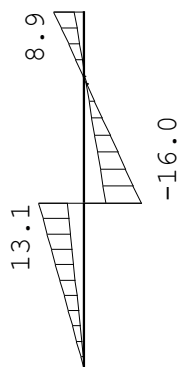

Project.....: 10745
 Onderdeel....: tussenkolom

DWARSKRACHTEN

Fundamentele combinatie

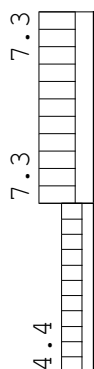

NORMAALKRACHTEN

Fundamentele combinatie

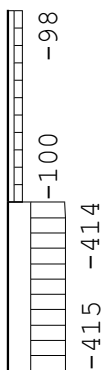

STAAFKRACHTEN

Fundamentele combinatie

St.	Kn.	Pos.	NXi/NXj		DZi/DZj		MYi/MYj						
			Min	Max	BC	BC	Min	Max	BC	BC			
1	1		-415.35	-160.13	4	2	1.69	4.38	4	0.00	0.00	2	4
1	2		-413.85	-159.01	4	2	1.69	4.38	4	5.06	13.15	2	4
2	2		-99.68	-38.86	4	2	2.64	7.32	4	-16.03	-5.96	4	2
2		2.180	-98.60	-38.05	4	2	2.64	7.32	4	-0.33	0.00	1	5
2		2.263	-98.55	-38.02	4	2	2.64	7.32	4	0.00	0.53	1	5
2	3		-97.99	-37.59	4	2	2.64	7.32	4	3.00	8.86	2	4

REACTIES

Fundamentele combinatie

Kn.	X-min	X-max	Z-min	Z-max	M-min	M-max
1	1.69	4.38	160.13	415.35		
2	0.95	2.94				
3	-7.32	-2.64				

Project.....: 10745
 Onderdeel....: tussenkolom

OMHULLENDE VAN DE KARAKTERISTIEKE COMBINATIES

VERPLAATSINGEN [mm] Karakteristieke combinatie

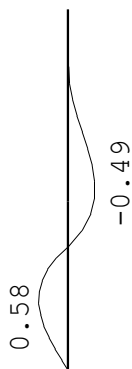

STAALPROFIELEN - ALGEMENE GEGEVENS

Stabiliteit: Classificatie gehele constructie: Geschoord
 Doorbuiging en verplaatsing:
 Aantal bouwlagen: 1
 Gebouwtype: Overig
 Toel. horiz. verplaatsing gehele gebouw: h/250
 Kleinste gevelhoogte [m]: 0.0

PROFIEL/MATERIAAL

P/M nr.	Profielnaam	Vloeisps. [N/mm ²]	Productie methode	Min. drsn. klasse
1	B273/6.3	235	Warmgewalst	1

Partiële veiligheidsfactoren:
 Gamma M;0 : 1.00 Gamma M;1 : 1.00
 Gamma M;fi;mech : 1.00 Gamma M;fi;therm : 1.00

KNIKSTABILITEIT

Staafl	l _{sys} [m]	Classif. y sterke as	l _{knik;y} [m]	Extra		l _{knik;z} [m]	Extra	
				aanp. y [kN]	Classif. z zwakke as		aanp. z [kN]	
1	3.000	Geschoord	3.000	0.0	Geschoord	3.000	0.0	0.0
2	3.400	Geschoord	3.400	0.0	Geschoord	3.400	0.0	0.0

KIPSTABILITEIT

Staafl	Plts. aangr.	l gaffel [m]	Kipsteunafstanden [m]	
			boven:	onder:
1	1.0*h	3.00	3.000	3.000
			3.000	
2	1.0*h	3.40	3.4	3.4
			3.4	

Project.....: 10745
 Onderdeel....: tussenkolom

TOETSING SPANNINGEN

nr.	Staafl	P/M	BC	Sit	Kl	Plaats	Norm	Artikel	Formule	Hoogste toetsing U.C. [N/mm ²]	Opm.
1	1	4	1	1	Staafl	EN3-1-1	6.3.3	(6.61)	0.424	100	
2	1	4	1	1	Begin	EN3-1-1	6.2.10	(6.45+6.31y)	0.154	36	

TOETSING HORIZONTALE VERPLAATSING

Staafl	BC	Sit	Lengte [m]	U _{eind} [mm]	Toelaatbaar [mm]	Maatgevend [h/]
1	7	1	3.000	0.6	12.0	250 doorbuiging
2	7	1	3.400	-0.5	13.6	250 doorbuiging

controle combinatie brand

N_{Ed;brand}

e.g.uit_dak_asB	23.77		*1.0	= 23.77 kN
dak_schuin_fundering	0.87 * 5.25*0.5 * 7.88		*1.0	= 18.00 kN
e.g.uit_as2/A-B	87.5		*1.0	= 87.50 kN
e.g.uit_as2/B-C	46.0		*1.0	= 46.00 kN
v.b.uit_as2/A-B	68.9	*0.6	*1.0	= 41.34 kN
v.b.uit_as2/B-C	33.75	*0.6	*1.0	= 20.25 kN
Totaal				= 236.86 kN

PotFire - V3.2.3 (EN 1994-1-2 + French National Annex)

Section
 Type of section: Circular
 Size of steel section:
 Diameter: 273 mm
 Thickness: 6.3 mm

Material characteristics
 Yield strength of structural steel: 235 MPa
 Compressive strength of concrete (cylinder at 28 days): 20 MPa
 Yield strength of rebars: 500 MPa

Fire calculation Room temperature calculation

Rebars
 By number of rebars By %
 Percentage (A_s/(A_c+A_s)): 0 %
 Axis distance of rebars: 30 mm
 Equal to 8 rebars of diameter: mm

Calculation of
 Ultimate load
 Standard fire resistance duration: 60 min

Effective length
 Length: 1.5 m

Partial safety factors
 Structural steel factor: 1
 Concrete factor: 1
 Reinforcing steel factor: 1

Eccentricity of the load
 Eccentricity: 0 mm

Result
 Non-dimensional slenderness: 0.213
 Ultimate load: 723 kN

3.6 Kolommen dakoverstek stramien A/1

Maatgevend is de kolom onder de nok
 lengte ±8.0 m
 excentriciteit 2.0 m

belasting

dak_schuin	$0.75 * 3.00 * 3.00$	= 6.75 kN
sneeuw_aang_gem	$1.12 * 3.00 * 3.00$	= 10.08 kN
wind	$-0.94 * 1.3 * 3.00 * 3.00$	= - 11.00 kN

belasting uit andere kolommen op poer

dak_schuin	$0.75 * 2.80 * 2.00 * 2$	= 8.40 kN
sneeuw_aang_gem	$1.12 * 2.80 * 2.00 * 2$	= 12.54 kN
wind	$-0.94 * 1.3 * 2.80 * 2.00 * 2$	= - 13.69 kN

Technosoft Raamwerken release 6.84b

20 nov 2025

Project.....: 10745
 Onderdeel....: kolommen overstek
 Dimensies....: kN;m;rad (tenzij anders aangegeven)
 Bestand.....: N:\Order\10000\10700\10745\berekeningen en
 schetsen\kolommen overstek.rww

Belastingbreedte.: 1.000
 Rekenmodel.....: 1e-orde-elastisch.
 Theorie voor de bepaling van de krachtsverdeling:
 Geometrisch lineair.
 Fysisch lineair.

Gunstige werking van de permanente belasting wordt automatisch verwerkt.

Toegepaste normen volgens Eurocode met Nederlandse NB

Belastingen	NEN-EN 1990:2002	C2:2010,A1:2019	NB:2019(nl)
	NEN-EN 1991-1-1:2002	C1/C11:2019	NB:2019(nl)
	NEN-EN 1991-1-3:2003	A1:2019	NB:2019(nl)
	NEN-EN 1991-1-4:2005	C2:2023	NB:2019(nl)
Staal	NEN-EN 1993-1-1:2006	C2:2011,A1:2016	NB:2016(nl)

GEOMETRIE

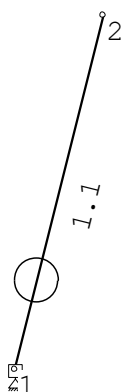

MATERIALEN

Mt	Kwaliteit	E-modulus [N/mm ²]	S.G.	Pois.	Uitz. coëff
1	S235	210000	78.5	0.30	1.2000e-05

PROFIELEN [mm]

Prof.	Omschrijving	Materiaal	Oppervlak	Traagheid	Vormf.
1	B273/6.3	1:S235	5.2785e+03	4.6958e+07	0.00

Project.....: 10745
 Onderdeel....: kolommen overstek

PROFIELEN vervolg [mm]

Prof.	Staaftype	Breedte	Hoogte	e	Type	b1	h1	b2	h2
1	0:Normaal	273	273	136.5					

PROFIELVORMEN [mm]

1 B273/6.3



KNOPEN

Knoop	X	Z
1	0.000	0.000
2	2.000	8.000

STAVEN

St.	ki	kj	Profiel	Aansl.i	Aansl.j	Lengte	Opm.
1	1	2	1:B273/6.3	NDM	NDM	8.246	

VASTE STEUNPUNTEN

Nr. knoop	Kode	XZR 1=vast 0=vrij	Hoek
1	1 111		0.00

BELASTINGGEVALLEN

B.G.	Omschrijving	EGZ	Type
1	Permanente belasting	EGZ=-1.00	1
2	Wind van links onderdruk A		7
3	Sneeuw A		22

BELASTINGEN

B.G:1 Permanente belasting

Eigen gewicht van alle staven is meegenomen in berekening. Richting:↓

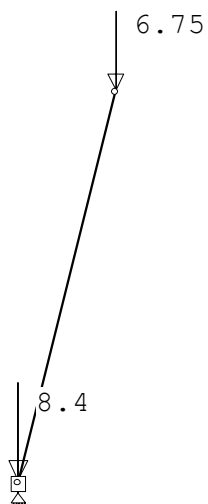

Project.....: 10745
 Onderdeel....: kolommen overstek

KNOOPBELASTINGEN

B.G:1 Permanente belasting

Last	Knoop	Richting	waarde	ψ_0	ψ_1	ψ_2
1	2	Z	-6.750			
2	1	Z	-8.400			

BELASTINGEN

B.G:2 Wind van links onderdruk A

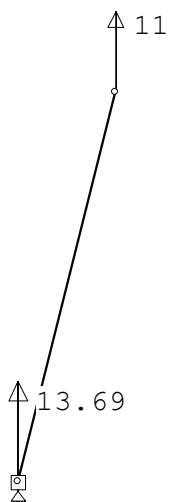

KNOOPBELASTINGEN

B.G:2 Wind van links onderdruk A

Last	Knoop	Richting	waarde	ψ_0	ψ_1	ψ_2
1	2	Z	11.000	0.00	0.20	0.00
2	1	Z	13.690	0.00	0.20	0.00

BELASTINGEN

B.G:3 Sneeuw A

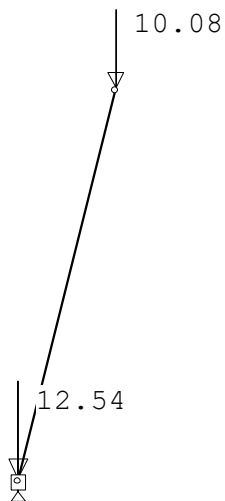

Project.....: 10745
 Onderdeel....: kolommen overstek

KNOOPBELASTINGEN

B.G:3 Sneeuw A

Last	Knoop	Richting	waarde	Ψ_0	Ψ_1	Ψ_2
1	2	Z	-10.080	0.00	0.20	0.00
2	1	Z	-12.540	0.00	0.20	0.00

REACTIES

Kn.	B.G.	X	Z	M
1	1	0.00	18.57	-16.92
1	2	0.00	-24.69	22.00
1	3	0.00	22.62	-20.16

BELASTINGCOMBINATIES

BC	Type	BG	Gen.	Factor	BG	Gen.	Factor	BG	Gen.	Factor	BG	Gen.	Factor
1	Fund.	1	Perm	1.35									
2	Fund.	1	Perm	0.90									
3	Fund.	1	Perm	1.20	2	Extr	1.50						
4	Fund.	1	Perm	1.20	3	Extr	1.50						
5	Fund.	1	Perm	0.90	2	Extr	1.50						
6	Fund.	1	Perm	0.90	3	Extr	1.50						
7	Kar.	1	Perm	1.00	2	Extr	1.00						
8	Kar.	1	Perm	1.00	3	Extr	1.00						
9	Quas.	1	Perm	1.00									
10	Freq.	1	Perm	1.00									
11	Freq.	1	Perm	1.00	2	psil	1.00						
12	Freq.	1	Perm	1.00	3	psil	1.00						
13	Blij.	1	Perm	1.00									

GUNSTIGE WERKING PERMANENTE BELASTINGEN

BC	Staven met gunstige werking
1	Geen
2	Alle staven de factor:0.90
3	Geen
4	Geen
5	Alle staven de factor:0.90
6	Alle staven de factor:0.90

Project.....: 10745
Onderdeel.....: kolommen overstek

OMHULLENDE VAN DE FUNDAMENTELE COMBINATIES

MOMENTEN

Fundamentele combinatie

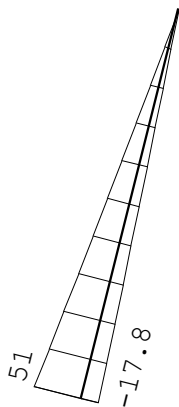

DWARSKRACHTEN

Fundamentele combinatie

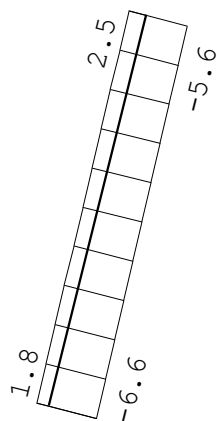

Project.....: 10745
 Onderdeel....: kolommen overstek

NORMAALKRACHTEN

Fundamentele combinatie

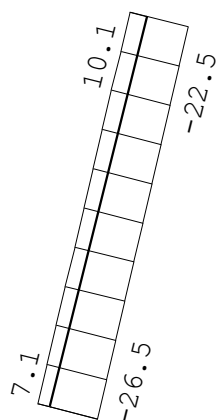

STAAFKRACHTEN

Fundamentele combinatie

St.	Kn.	Pos.	NXi/NXj		DZi/DZj		MYi/MYj	
			Min BC	Max BC	Min BC	Max BC	Min BC	Max BC
1	1		-26.50	7.13	-6.63	1.78	-17.77	50.54
1	2		-22.53	10.11	-5.63	2.53	0.00	-0.00

REACTIES

Fundamentele combinatie

Kn.	X-min	X-max	Z-min	Z-max	M-min	M-max
1	0.00	0.00	-20.32	56.21	-50.54	17.77

STAALPROFIELEN - ALGEMENE GEGEVENS

Stabiliteit: Classificatie gehele constructie: Geschoord
 Doorbuiging en verplaatsing:
 Aantal bouwlagen: 1
 Gebouwtype: Overig
 Toel. horiz. verplaatsing gehele gebouw: h/300
 Kleinste gevelhoogte [m]: 0.0

PROFIEL/MATERIAAL

P/M nr.	Profielnaam	Vloeisp. [N/mm ²]	Productie methode	Min. drsn. klasse
1	B273/6.3	235	Warmgewalst	1

Partiële veiligheidsfactoren:
 Gamma M;0 : 1.00 Gamma M;1 : 1.00
 Gamma M;fi;mech : 1.00 Gamma M;fi;therm : 1.00

KNIKSTABILITEIT

Staafl	l _{sys} [m]	Classif. y sterke as	l _{knik,y} [m]	Extra		l _{knik,z} [m]	Extra	
				aanp. y [kN]	Classif. z zwakke as		aanp. z [kN]	
1	8.246	Geschoord	8.246	0.0	Geschoord	8.246	0.0	

Project.....: 10745
 Onderdeel....: kolommen overstek

KIPSTABILITEIT

Staafl	Plts. aangr.	l gaffel	Kipsteunafstanden
		[m]	[m]
1	1.0*h	boven:	8.25 8.246
		onder:	8.246

TOETSING SPANNINGEN

Staafl	P/M	BC	Sit	Kl	Plaats	Norm	Artikel	Formule	Hoogste toetsing	Opm.
	nr.								U.C. [N/mm ²]	
1	1	4	1	1	Begin	EN3-1-1	6.2.10	(6.45+6.31y)	0.481	113

TOETSING DOORBUIGING

Staafl	Soort	Mtg	Lengte	Overst	Zeeg	u _{tot}	BC	Sit	u	Toelaatbaar
			[m]	I	J	[mm]			[mm]	[mm] *1
1	Dak	ss	8.25	N	J	0.0 -36.9	9	1 Eind	-36.9	±66.0 2*0.004
		ss					7	1 Bijk	50.6	±66.0 2*0.004

TOETSING HOR. VERPLAATSING GLOBAAL

Er is een maximale horizontale verplaatsing van 0.0807 [m] gevonden bij knoop 2 en combinatie 8; belastingsituatie 1 (combinatietype 2). Bij een hoogte van 8.000 [m] levert dit h / 99 (toel.: h / 300).

Kolom gesteund aan de bovenzijde geeft een horizontaalkracht V_{Ed} = 6.3 kN. Dit kan door het dakvlak opgenomen worden waardoor geen de overschrijding van de doorbuiging.

3.7 Ligger dakoverstek

belasting

dak_schuin_fundering	0.87 * 1.65	= 1.44 kN/m ¹
sneeuw_aang_gem	1.12 * 1.65	= 1.85 kN/m ¹

Technosoft Raamwerken release 6.84b

20 nov 2025

Project.....: 10745
 Onderdeel....: Ligger dakoverstek
 Dimensies....: kN;m;rad (tenzij anders aangegeven)
 Bestand.....: N:\Order\10000\10700\10745\berekeningen en
 schetsen\Ligger dakoverstek.rww

Belastingbreedte.: 1.000
 Rekenmodel.....: 1e-orde-elastisch.
 Theorie voor de bepaling van de krachtsverdeling:
 Geometrisch lineair.
 Fysisch lineair.

Gunstige werking van de permanente belasting wordt automatisch verwerkt.

Toegepaste normen volgens Eurocode met Nederlandse NB

Belastingen	NEN-EN 1990:2002	C2:2010,A1:2019	NB:2019 (nl)
	NEN-EN 1991-1-1:2002	C1/C11:2019	NB:2019 (nl)
	NEN-EN 1991-1-3:2003	A1:2019	NB:2019 (nl)
Staal	NEN-EN 1993-1-1:2006	C2:2011,A1:2016	NB:2016 (nl)

GEOMETRIE



MATERIALEN

Mt	Kwaliteit	E-modulus [N/mm ²]	S.G.	Pois.	Uitz. coëff
1	S235	210000	78.5	0.30	1.2000e-05

PROFIELEN [mm]

Prof.	Omschrijving	Materiaal	Oppervlak	Traagheid	Vormf.
1	K150/100/6CF	1:S235	2.7633e+03	8.3469e+06	0.00

PROFIELEN vervolg [mm]

Prof.	Staaftype	Breedte	Hoogte	e	Type	b1	h1	b2	h2
1	0:Normaal	100	150	75.0					

PROFIELVORMEN [mm]

1 K150/100/6CF



KNOPEN

Knoop	X	Z
1	0.000	0.000
2	2.800	0.000
3	4.000	0.000

Project.....: 10745
 Onderdeel....: Ligger dakoverstek

STAVEN

St.	ki	kj	Profiel	Aansl.i	Aansl.j	Lengte	Opm.
1	1	2	1:K150/100/6CF	NDM	NDM	2.800	
2	2	3	1:K150/100/6CF	NDM	NDM	1.200	

VASTE STEUNPUNTEN

Nr.	knoop	Kode	XZR 1=vast 0=vrij	Hoek
1	1	110		0.00
2	2	010		0.00

BELASTINGGEVALLEN

B.G.	Omschrijving	EGZ	Type
1	Permanente belasting	EGZ=-1.00	1
2	Sneeuw A		22

BELASTINGEN

B.G:1 Permanente belasting

Eigen gewicht van alle staven is meegenomen in berekening. Richting:↓

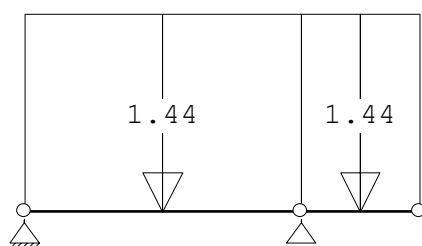

STAAFBELASTINGEN

B.G:1 Permanente belasting

Staafl	Type	q1/p/m	q2	A	B	ψ_0	ψ_1	ψ_2
1	5:QZGloaal	-1.44	-1.44	0.000	0.000			
2	5:QZGloaal	-1.44	-1.44	0.000	0.000			

BELASTINGEN

B.G:2 Sneeuw A

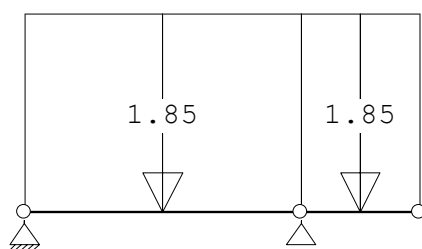

STAAFBELASTINGEN

B.G:2 Sneeuw A

Staafl	Type	q1/p/m	q2	A	B	ψ_0	ψ_1	ψ_2
1	3:QZgeProj.	-1.85	-1.85	0.000	0.000	0.00	0.20	0.00
2	3:QZgeProj.	-1.85	-1.85	0.000	0.000	0.00	0.20	0.00

REACTIES

Kn.	B.G.	X	Z	M
1	1	0.00	1.89	
1	2	0.00	2.11	

Project.....: 10745
 Onderdeel....: Ligger dakoverstek

REACTIES

Kn.	B.G.	X	Z	M
2	1		4.73	
2	2		5.29	

BELASTINGCOMBINATIES

BC Type	BG Gen. Factor	BG Gen. Factor	BG Gen. Factor	BG Gen. Factor
1 Fund.	1 Perm	1.35		
2 Fund.	1 Perm	0.90		
3 Fund.	1 Perm	1.20	2 Extr	1.50
4 Fund.	1 Perm	0.90	2 Extr	1.50
5 Kar.	1 Perm	1.00	2 Extr	1.00
6 Quas.	1 Perm	1.00		
7 Freq.	1 Perm	1.00		
8 Freq.	1 Perm	1.00	2 psil	1.00
9 Blij.	1 Perm	1.00		

GUNSTIGE WERKING PERMANENTE BELASTINGEN

BC Staven met gunstige werking
1 Geen
2 Alle staven de factor:0.90
3 Geen
4 Alle staven de factor:0.90

OMHULLENDE VAN DE FUNDAMENTELE COMBINATIES

MOMENTEN

Fundamentele combinatie

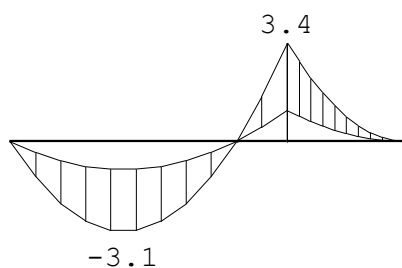

Project.....: 10745
 Onderdeel....: Ligger dakoverstek

DWARSKRACHTEN

Fundamentele combinatie

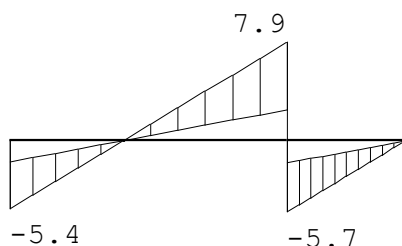

STAAFKRACHTEN

Fundamentele combinatie

St.	Kn.	Pos.	NXi/NXj			DZi/DZj			MYi/MYj					
			Min	BC	Max	BC	Min	BC	Max	BC	Min	BC	Max	BC
1	1		0.00	1	0.00	1	-5.44	3	-1.70	2	0.00	3	0.00	2
1	1.143		0.00	1	0.00	1	-0.00	3	0.00	2	-3.11	3	-0.97	2
1	2.286		0.00	1	0.00	1	1.70	2	5.44	3	-0.00	3	-0.00	2
1	2		0.00	1	0.00	1	2.47	2	7.89	3	1.07	2	3.43	3
2	2		0.00	1	0.00	1	-5.72	3	-1.79	2	1.07	2	3.43	3
2	3		0.00	1	0.00	1	-0.00	3	0.00	2	0.00	2	-0.00	3

REACTIES

Fundamentele combinatie

Kn.	X-min	X-max	Z-min	Z-max	M-min	M-max
1	0.00	0.00	1.70	5.44		
2			4.26	13.61		

STAALPROFIELEN - ALGEMENE GEGEVENS

Stabiliteit: Classificatie gehele constructie: Geschoord

PROFIEL/MATERIAAL

P/M nr.	Profielnaam	Vloeisp. [N/mm ²]	Productie methode	Min. drsn. klasse
1	K150/100/6CF	235	Koudgevormd	1

Partiële veiligheidsfactoren:
 Gamma M;0 : 1.00 Gamma M;1 : 1.00

KNIKSTABILITEIT

Staafl	l _{sys} [m]	Classif. y	sterke as	l _{knik,y} [m]	Extra		l _{knik,z} [m]	aanp. z [kN]
					aanp. y [kN]	Classif. z		
1	2.800	Geschoord	2.800	2.800	0.0	Geschoord	2.800	0.0
2	1.200	Geschoord	1.200	1.200	0.0	Geschoord	1.200	0.0

KIPSTABILITEIT

Staafl	Plts. aangr.	l gaffel [m]	Kipsteunafstanden [m]	
			boven:	onder:
1	1.0*h	2.80	2.8	2.8
			2.8	2.8
2	1.0*h	1.20	1.200	1.200
			1.200	1.200

Project.....: 10745
 Onderdeel....: Ligger dakoverstek

TOETSING SPANNINGEN

Staafr nr.	P/M	BC	Sit	Kl	Plaats	Norm	Artikel	Formule	Hoogste toetsing U.C. [N/mm ²]	Opm.
1	1	3	1	1	Einde	EN3-1-1	6.2.8	(6.29+6.12y)	0.107	25
2	1	3	1	1	Begin	EN3-1-1	6.2.8	(6.29+6.12y)	0.107	25

TOETSING DOORBUIGING

Staafr	Soort	Mtg	Lengte [m]	Overst I J	Zeeg [mm]	u _{tot} [mm]	BC	Sit	u [mm]	Toelaatbaar [mm]	*1	
1	Dak	db	2.80	N N	0.0	-0.9	5	1	Eind	-0.9	±11.2	0.004
		Bijk							-0.5	±11.2	0.004	
2	Dak	db	1.20	N J	0.0	0.1	5	1	Eind	0.1	±4.8	0.004
		Bijk							0.0	±4.8	0.004	

3.8 Kolom as 5

Maatgevend as E/5

Blijvende belasting

uit_ligger_as5	22.18	= 22.18 kN
metselwerk_D120mm	2.40 * 3.50 * 1.10	= 9.24 kN
Totaal		= 31.42 kN

Opgelegde belasting

uit_ligger_as5	5.50	= 5.50 kN
Totaal		= 5.50 kN

blijvend	=	31.42 kN	$\gamma_{G,6.10a} = 1.35$	$\gamma_{G,6.10b} = 1.2$
opgelegd	=	5.50 kN	$\gamma_Q = 1.5$	$\psi_{r0} = 0.4$
F_G	=	$1.00 * 31.42$	=	31.42 kN
F_{inst}	=	$1.00 * 31.42 + 1.00 * 5.50$	=	36.92 kN
$F_{d,6.10a}$	=	$1.35 * 31.42 + 1.50 * 5.50 * 0.40$	=	45.72 kN of
$F_{d,6.10b}$	=	$1.20 * 31.42 + 1.50 * 5.50$	=	45.95 kN

$M_{Ed} = 45.95 * 0.075 = 3.45 \text{ kNm}$

Project.....: 10745
 Onderdeel....: Kolom as 5
 Dimensies....: kN;m;rad (tenzij anders aangegeven)
 Bestand.....: N:\Order\10000\10700\10745\berekeningen en schetsen\Kolom
 as 5.rww

Belastingbreedte.: 1.000
 Rekenmodel.....: 1e-orde-elastisch.
 Theorie voor de bepaling van de krachtsverdeling:
 Geometrisch lineair.
 Fysisch lineair.

Gunstige werking van de permanente belasting wordt automatisch verwerkt.

Toegepaste normen volgens Eurocode met Nederlandse NB

Belastingen	NEN-EN 1990:2002	C2:2010,A1:2019	NB:2019 (nl)
	NEN-EN 1991-1-1:2002	C1/C11:2019	NB:2019 (nl)
	NEN-EN 1991-1-3:2003	A1:2019	NB:2019 (nl)
Staal	NEN-EN 1993-1-1:2006	C2:2011,A1:2016	NB:2016 (nl)



GEOMETRIE

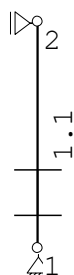

MATERIALEN

Mt	Kwaliteit	E-modulus [N/mm ²]	S.G.	Pois.	Uitz. coëff
1	S235	210000	78.5	0.30	1.2000e-05

PROFIELEN [mm]

Prof.	Omschrijving	Materiaal	Oppervlak	Traagheid	Vormf.
1	HEA160 (90)	1:S235	3.8800e+03	6.1600e+06	0.00

PROFIELEN vervolg [mm]

Prof.	Staaftype	Breedte	Hoogte	e	Type	b1	h1	b2	h2
1	0:Normaal	160	152	80.0					

Project.....: 10745
 Onderdeel....: Kolom as 5

PROFIELVORMEN [mm]

1 HEA160 (90)



KNOPEN

Knoop	X	Z
1	0.000	0.000
2	0.000	3.000

STAVEN

St.	ki	kj	Profiel	Aansl.i	Aansl.j	Lengte	Opm.
1	1	2	1:HEA160 (90)	NDM	NDM	3.000	

VASTE STEUNPUNTEN

Nr.	knoop	Kode	XZR	l=vast	0=vrij	Hoek
1	1	110				0.00
2	2	100				0.00

BELASTINGGEVALLEN

B.G.	Omschrijving	EGZ	Type
1	Permanente belasting	--1.00	1
2	Sneeuw A		22

BELASTINGEN

B.G:1 Permanente belasting

Eigen gewicht van alle staven is meegenomen in berekening. Richting:↓

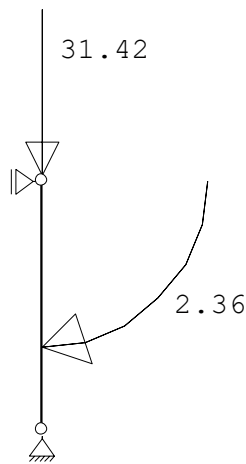

Project.....: 10745
 Onderdeel....: Kolom as 5

KNOOPBELASTINGEN

B.G:1 Permanente belasting

Last	Knoop	Richting	waarde	Ψ_0	Ψ_1	Ψ_2
1	2	Z	-31.420			
2	2	Rotatie Y	2.360			

BELASTINGEN

B.G:2 Sneeuw A

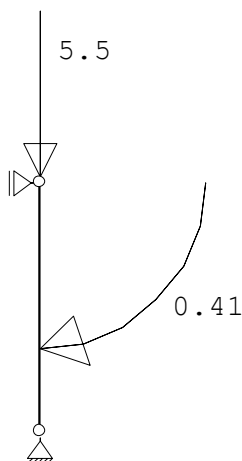

KNOOPBELASTINGEN

B.G:2 Sneeuw A

Last	Knoop	Richting	waarde	Ψ_0	Ψ_1	Ψ_2
1	2	Z	-5.500	0.40	0.70	0.60
2	2	Rotatie Y	0.410	0.40	0.70	0.60

REACTIES

Kn.	B.G.	X	Z	M
1	1	0.79	32.33	
1	2	0.14	5.50	
2	1	-0.79		
2	2	-0.14		

BELASTINGCOMBINATIES

BC Type	BG	Gen. Factor	BG	Gen. Factor	BG	Gen. Factor	BG	Gen. Factor
1	Fund.	1 Perm	1.35					
2	Fund.	1 Perm	0.90					
3	Fund.	1 Perm	1.20	2 Extr	1.50			
4	Fund.	1 Perm	0.90	2 Extr	1.50			
5	Kar.	1 Perm	1.00	2 Extr	1.00			
6	Blij.	1 Perm	1.00					

GUNSTIGE WERKING PERMANENTE BELASTINGEN

BC	Staven met gunstige werking
1	Geen
2	Alle staven de factor:0.90
3	Geen
4	Alle staven de factor:0.90

Project.....: 10745
Onderdeel.....: Kolom as 5

OMHULLENDE VAN DE FUNDAMENTELE COMBINATIES

MOMENTEN

Fundamentele combinatie

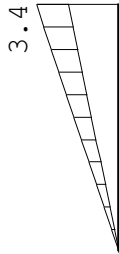

DWARSKRACHTEN

Fundamentele combinatie

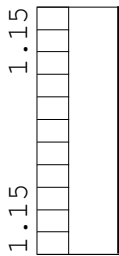

Project.....: 10745
 Onderdeel....: Kolom as 5

NORMAALKRACHTEN

Fundamentele combinatie

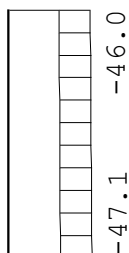

STAAFKRACHTEN

Fundamentele combinatie

St.	Kn.	Pos.	NXi/NXj		DZi/DZj		MYi/MYj							
			Min BC	Max BC	Min BC	Max BC	Min BC	Max BC						
1	1		-47.05	3	-29.10	2	0.71	2	1.15	3	0.00	2	0.00	3
1	2		-45.95	3	-28.28	2	0.71	2	1.15	3	2.12	2	3.45	3

REACTIES

Fundamentele combinatie

Kn.	X-min	X-max	Z-min	Z-max	M-min	M-max
1	0.71	1.15	29.10	47.05		
2	-1.15	-0.71				

STAALPROFIELEN - ALGEMENE GEGEVENS

Stabiliteit: Classificatie gehele constructie: Geschoord
 Doorbuiging en verplaatsing:
 Aantal bouwlagen: 1
 Gebouwtype: Overig
 Toel. horiz. verplaatsing gehele gebouw: h/300
 Kleinste gevelhoogte [m]: 0.0

PROFIEL/MATERIAAL

P/M nr.	Profielnaam	Vloeisp. [N/mm ²]	Productie methode	Min. drsn. klasse
1	HEA160 (90)	235	Gewalst	1

Partiële veiligheidsfactoren:
 Gamma M;0 : 1.00 Gamma M;1 : 1.00
 Gamma M;fi;mech : 1.00 Gamma M;fi;therm : 1.00

KNIKSTABILITEIT

StAAF	l _{sys} [m]	Classif. y sterke as	l _{knik;y} [m]	Extra		l _{knik;z} [m]	Extra	
				aanp. y [kN]	Classif. z zwakke as		aanp. z [kN]	
1	3.000	Geschoord	3.000	0.0	Geschoord	3.000	0.0	

KIPSTABILITEIT

StAAF	Plts. aangr.	1 gaffel [m]	Kipsteunafstanden [m]
1	1.0*h	boven: 3.00 onder: 3	3

TOETSING SPANNINGEN

StAAF nr.	P/M	BC	Sit	Kl	Plaats	Norm	Artikel	Formule	Hoogste toetsing U.C. [N/mm ²]	Opm.
1	1	3	1	1	StAAF	EN3-1-1	6.3.3	(6.62)	0.159	37

4 METSELWERK

4.1 Wand as E

Verticaal steunen h.o.h. max. 3500 mm.

Kies $3500 / 30 = 117$ mm kies wanddikte 120 mm

[Artikel NEN-EN 1996 5.5.1.2 (7)]

Verbinden met kolommen HEA160

4.2 Wand as 5

Horizontaal steunen door verdiepingsvloer h.o.h. max. 3200 mm.

Kies $3200 / 27 = 119$ mm kies wanddikte 120 mm

[Artikel NEN-EN 1996 6.1.2.2 NB]

algemeen			
gevolgkasse		:	CC2
materiaalfactor	γ_M	:	1.7
soort wand		:	enkel blad geschoord
materiaal van wand		:	kalkzandsteen
gemiddelde druksterkte steen	f_b	:	12 N/mm ²
elasticiteitsmodulus	E	:	700 * f_k
perforaties in steen		:	25 %
soort mortel		:	lijmmortel
gemiddelde druksterkte mortel		:	12.5 N/mm ²

Verdieping

Q_{Ed}

dak_plat_beton	5.00 * 1.10	*1.2	= 6.60 kN/m ¹
dak_plat_hout	0.90 * 1.40	*1.2	= 1.51 kN/m ¹
dak_plat_verdeeld	1.00 * 2.50	*1.5	= 3.75 kN/m ¹
Totaal			= 11.86 kN/m ¹

bepaling druksterkte op basis van de samengestelde mat

		:	6.61 N/mm ²
w aarin	K	:	0.8
	α	:	0.85
	β	:	0
rekenwaarde druksterkte (f_k / γ_M)	f_d	:	3.89 N/mm ²
reductie bij $A < 0.1$ m ²	red.	:	1
	f_d	:	3.89 N/mm ²

Toetsing $N_{Ed} \leq N_{Rd}$

	Φ	b	t	f_d	* 10^{-3}	N_{Rd}	N_{Ed}
boven	0.900	1000	120	3.89	* 10^{-3}	= 420.12 kN	11.86 kN
midden	0.528	1000	120	3.89	* 10^{-3}	= 246.68 kN	11.86 kN
onder	0.900	1000	120	3.89	* 10^{-3}	= 420.12 kN	11.86 kN
eerste orde excentriciteit	0.263	1000	120	3.89	* 10^{-3}	= 122.85 kN	11.86 kN

Begane grond

Blijvende belasting

dak_plat_beton	5.00 * 1.10	=	5.50 kN/m ¹
dak_plat_hout	0.90 * 1.40	=	1.26 kN/m ¹
metselwerk_D120mm	2.40 * 3.20	=	7.68 kN/m ¹
verdiepingsvloer_D200	6.15 * 1.10	=	6.77 kN/m ¹
Totaal		=	21.21 kN/m ¹

Opgelegde belasting

verdiepingsvloer_D200	5.00 * 1.10	=	5.50 kN/m ¹
Totaal		=	5.50 kN/m ¹

blijvend	=	21.21 kN/m ¹	$\gamma_{G,6.10a} = 1.35$	$\gamma_{G,6.10b} = 1.2$
opgelegd	=	5.50 kN/m ¹	$\gamma_Q = 1.5$	$\psi_0 = 0.4$
q_G	=	$1.00 * 21.21$	=	21.21 kN/m ¹
q_{inst}	=	$1.00 * 21.21 + 1.00 * 5.50$	=	26.71 kN/m ¹
$q_{freq,6.15}$	=	$1.00 * 21.21 + 1.00 * 5.50 * 0.70$	=	25.06 kN/m ¹
$q_{d,6.10a}$	=	$1.35 * 21.21 + 1.50 * 5.50 * 0.40$	=	31.93 kN/m ¹ of
$q_{d,6.10b}$	=	$1.20 * 21.21 + 1.50 * 5.50$	=	33.70 kN/m ¹

wandhoogte 2.80 m

Toetsing $N_{Ed} \leq N_{Rd}$								
	Φ	b	t	f_d	$* 10^{-3}$	N_{Rd}	N_{Ed}	UC
boven	0.900	1000	120	3.89	$* 10^{-3}$	= 420.12 kN	33.70 kN	0.08
midden	0.605	1000	120	3.89	$* 10^{-3}$	= 282.43 kN	33.70 kN	0.12
onder	0.900	1000	120	3.89	$* 10^{-3}$	= 420.12 kN	33.70 kN	0.08
eerste orde excentriciteit	0.360	1000	120	3.89	$* 10^{-3}$	= 168.24 kN	33.70 kN	0.20

Naast deurkozijn as B: $N_{Ed} = 33.70 * 2.0 + 26.34 = 93.7$ kN UC = $93.7 / 168.2 = 0.56$

4.3 Wand D200 mm

Maatgevend naast deuropening as 3

$$N_{Ed} = 125.51 * 2.00 = 251 \text{ kN}$$

Toetsing $N_{Ed} \leq N_{Rd}$								
	Φ	b	t	f_d	$* 10^{-3}$	N_{Rd}	N_{Ed}	UC
boven	0.900	1000	214	3.89	$* 10^{-3}$	= 749.21 kN	251.00 kN	0.34
midden	0.810	1000	214	3.89	$* 10^{-3}$	= 674.45 kN	251.00 kN	0.37
onder	0.900	1000	214	3.89	$* 10^{-3}$	= 749.21 kN	251.00 kN	0.34
eerste orde excentriciteit	0.732	1000	214	3.89	$* 10^{-3}$	= 609.43 kN	251.00 kN	0.41

5 BETONCONSTRUCTIE

5.1 Belastingopstelling fundering

Balk as 1

blijvend

q1

gevel $1.00 * 7.00 = 7.00 \text{ kN/m}^1$

Fa

dak_schuin_fundering $0.87 * 5.75 * 5.75 = 28.76 \text{ kN}$
e.g.uit_randligger_as1 52.34 = 52.34 kN

Totaal = 81.10 kN

Fb

dak_schuin_fundering $0.87 * 5.00 * 5.38 = 23.40 \text{ kN}$
e.g.uit_randligger_as1 52.34 = 52.34 kN

Totaal = 75.74 kN

Fc

dak_schuin_fundering $0.87 * 4.50 * 5.56 = 21.77 \text{ kN}$
e.g.uit_randligger_as1 126.7 = 126.70 kN

Totaal = 148.47 kN

Fd

dak_schuin_fundering $0.87 * 4.00 * 5.125 = 17.84 \text{ kN}$
e.g.uit_randligger_as1 $45.05 * 5.125 = 230.88 \text{ kN}$

Totaal = 248.72 kN

Fe

dak_schuin_fundering $0.87 * 4.00 * 3.42 = 11.90 \text{ kN}$
e.g.uit_randligger_as1 $45.05 * 3.42 = 154.07 \text{ kN}$

Totaal = 165.97 kN

opgelegd

Fa en Fb

e.g.uit_randligger_as1 34.13 = 34.13 kN

Fc

e.g.uit_randligger_as1 73.83 = 73.83 kN

Fd

e.g.uit_randligger_as1 $26.25 * 5.125 = 134.53 \text{ kN}$

Fe

e.g.uit_randligger_as1 $26.25 * 3.42 = 89.78 \text{ kN}$

wind / sneeuw

Fa

sneeuw_aang_gem $1.12 * 5.75 * 5.75 = 37.03 \text{ kN}$

Fb

sneeuw_aang_gem $1.12 * 5.00 * 5.38 = 30.13 \text{ kN}$

Fc

sneeuw_aang_gem $1.12 * 4.50 * 5.56 = 28.02 \text{ kN}$

Fd

sneeuw_aang_gem $1.12 * 4.00 * 5.125 = 22.96 \text{ kN}$

Fe

sneeuw_aang_gem $1.12 * 4.00 * 3.42 = 15.32 \text{ kN}$

As D1

N_{Ed}			
e.g.	248.72	*1.2	= 298.46 kN
v.b.	134.53	*1.5	= 201.80 kN
Totaal			= 500.26 kN

As E1

N_{Ed}			
e.g.	165.97	*1.2	= 199.16 kN
v.b.	89.78	*1.5	= 134.67 kN
Totaal			= 333.83 kN

As C1

N_{Ed}			
e.g.	148.47	*1.2	= 178.16 kN
v.b.	73.83	*1.5	= 110.75 kN
Totaal			= 288.91 kN

Balk as A

blijvend

q1			
gevel	1.00 * 7.00		= 7.00 kN/m ¹

F2 en F3

dak_schuin_fundering	0.87 * 5.00 * 5.25		= 22.84 kN
e.g.uit_as_2/A-B	87.52		= 87.52 kN
Totaal			= 110.36 kN

F4

dak_schuin_fundering	0.87 * 4.00 * 3.75		= 13.05 kN
----------------------	--------------------	--	------------

F5

dak_schuin_fundering	0.87 * 4.00 * 1.10		= 3.83 kN
uit_kolom_as_5	35.83		= 35.83 kN
Totaal			= 39.66 kN

opgelegd

F2 en F3

v.b.uit_as_2/A-B	68.91		= 68.91 kN
------------------	-------	--	------------

F5

uit_kolom_as_5	5.50		= 5.50 kN
----------------	------	--	-----------

wind / sneeuw

F2 en F3

sneeuw_aang_gem	1.12 * 5.00 * 5.25		= 29.40 kN
-----------------	--------------------	--	------------

F4

sneeuw_aang_gem	1.12 * 4.00 * 3.75		= 16.80 kN
-----------------	--------------------	--	------------

F5

sneeuw_aang_gem	1.12 * 4.00 * 1.10		= 4.93 kN
-----------------	--------------------	--	-----------

maatgevend

N_{Ed}			
e.g.	110.36	*1.2	= 132.43 kN
v.b.	68.91	*1.5	= 103.37 kN
Totaal			= 235.80 kN

F4

N_{Ed}			
e.g.	13.05	*1.2	= 15.66 kN
s.n.	16.80	*1.5	= 25.20 kN
Totaal			= 40.86 kN

spreidbalk F4

spreiden over 2 m¹

$$q_{Ed} = 40.86 / 2.00 = 20.43 \text{ kN/m}^1$$

$$M_{Ed} = 1/10 * 20.43 * 1.00^2 = 2.04 \text{ kNm}$$

$$V_{Ed} = 40.86 / 2 = 20.43 \text{ kN}$$

belasting F4 op strook tussen as 3-4

$$\text{e.g.} \quad 15.66 / 2.00 = 7.83 \text{ kN}$$

$$\text{gevel} \quad 1.00 * 3.50 = 3.50 \text{ kN}$$

$$\text{s.n.} \quad 16.80 / 2.00 = 8.40 \text{ kN}$$

Balk as B

blijvend

$$\text{verdiepingsvloer_D200} \quad 6.15 * 2.75 = 16.91 \text{ kN/m}^1$$

$$\text{dak_schuin_fundering} \quad 0.87 * 5.25 * 0.5 = 2.28 \text{ kN/m}^1$$

$$\text{metselwerk_D214mm} \quad 4.00 * 6.40 = 25.60 \text{ kN/m}^1$$

$$\text{Totaal} = 44.79 \text{ kN/m}^1$$

wind / sneeuw

$$\text{sneeuw_aang_gem} \quad 1.12 * 5.38 = 6.03 \text{ kN/m}^1$$

$$q_{Ed} \quad 1.2 * 44.79 + 1.5 * 6.04 = 62.81 \text{ kN/m}^1$$

Balk as C

blijvend

$$\text{verdiepingsvloer_D200} \quad 6.15 * 2.75 = 16.91 \text{ kN/m}^1$$

$$\text{uit dakliggers} \quad 32.47 / 3.50 = 9.28 \text{ kN/m}^1$$

$$\text{metselwerk_D214mm} \quad 4.00 * 6.40 = 25.60 \text{ kN/m}^1$$

$$\text{Totaal} = 51.79 \text{ kN/m}^1$$

wind / sneeuw

$$\text{sneeuw_aang_gem} \quad 1.12 * 2.75 = 3.08 \text{ kN/m}^1$$

$$\text{uit dakliggers} \quad 15.78 / 3.50 = 4.51 \text{ kN/m}^1$$

$$\text{Totaal} = 7.59 \text{ kN/m}^1$$

$$q_{Ed} \quad 1.2 * 51.79 + 1.5 * 7.59 = 73.53 \text{ kN/m}^1$$

Balk as E

blijvend

$$\text{uit dakliggers} \quad 32.47 / 3.50 = 9.28 \text{ kN/m}^1$$

$$\text{metselwerk_D120mm} \quad 2.40 * 7.00 = 16.80 \text{ kN/m}^1$$

$$\text{Totaal} = 26.08 \text{ kN/m}^1$$

wind / sneeuw

$$\text{uit dakliggers} \quad 15.78 / 3.50 = 4.51 \text{ kN/m}^1$$

$$q_{Ed} \quad 1.2 * 26.08 + 1.5 * 4.41 = 37.91 \text{ kN/m}^1$$

spreidbalk

$$N_{Ed} = 62.63 \text{ kN (uit dakligger)}$$

$$q_{Ed} = 62.63 / 3.50 = 17.89 \text{ kN/m}^1$$

$$M_{Ed} = 1/10 * 17.89 * 3.50^2 = 27.4 \text{ kNm}$$

$$V_{Ed} = 17.89 * 3.50 * 0.5 = 31.3 \text{ kN}$$

Balk as 3 / B-C tpv lift*blijvend*

q1

verdiepingsvloer_D200	$6.15 * 5.25 * 0.5$	= 16.14 kN/m ¹
metselwerk_D150mm	$3.00 * 6.40$	= 19.20 kN/m ¹

Totaal	=	<u>35.34 kN/m¹</u>
--------	---	-------------------------------

q2

verdiepingsvloer_D200	$6.15 * 5.25$	= 32.29 kN/m ¹
metselwerk_D214mm	$4.00 * 6.40$	= 25.60 kN/m ¹

Totaal	=	<u>57.89 kN/m¹</u>
--------	---	-------------------------------

q3

verdiepingsvloer_D200	$6.15 * 5.25 * 0.5$	= 16.14 kN/m ¹
metselwerk_D150mm	$3.00 * 6.40$	= 19.20 kN/m ¹

Totaal	=	<u>35.34 kN/m¹</u>
--------	---	-------------------------------

q4

dak_plat_beton	$5.00 * 1.10$	= 5.50 kN/m ¹
verdiepingsvloer_D200	$6.15 * 3.70$	= 22.76 kN/m ¹
metselwerk_D214mm	$4.00 * 6.40$	= 25.60 kN/m ¹

Totaal	=	<u>53.86 kN/m¹</u>
--------	---	-------------------------------

opgelegd

q1

verdiepingsvloer_D200	$5.00 * 5.25 * 0.5$	= 13.13 kN/m ¹
-----------------------	---------------------	---------------------------

q2

verdiepingsvloer_D200	$5.00 * 5.25$	= 26.25 kN/m ¹
-----------------------	---------------	---------------------------

q3

verdiepingsvloer_D200	$5.00 * 5.25 * 0.5$	= 13.13 kN/m ¹
-----------------------	---------------------	---------------------------

q4

verdiepingsvloer_D200	$5.00 * 3.70$	= 18.50 kN/m ¹
-----------------------	---------------	---------------------------

wind / sneeuw

q4

sneeuw_aang_gem	$1.12 * 1.10$	= 1.23 kN/m ¹
-----------------	---------------	--------------------------

Balk as 3 / C-E*blijvend*

verdiepingsvloer_D320	$7.45 * 5.25$	= 39.11 kN/m ¹
verdiepingsvloer_D200	$6.15 * 2.60$	= 15.99 kN/m ¹
metselwerk_D214mm	$4.00 * 2.80$	= 11.20 kN/m ¹

Totaal	=	<u>66.30 kN/m¹</u>
--------	---	-------------------------------

opgelegd

verdiepingsvloer_D320	$5.00 * 5.25$	= 26.25 kN/m ¹
verdiepingsvloer_D200	$5.00 * 2.60$	= 13.00 kN/m ¹

Totaal	=	<u>39.25 kN/m¹</u>
--------	---	-------------------------------

q _{Ed}	$1.2 * 66.30 + 1.5 * 39.25$	= 138.44 kN/m ¹
-----------------	-----------------------------	----------------------------

spreidbalk (belasting uit 3.3.7 ligger as 3 vergaderruimte - berging)

$$M_{Ed} = 1/10 * 125.51 * 2.00^2 = 50.2 \text{ kNm}$$

$$V_{Ed} = 125.51 \text{ kN}$$

Balk as 4 / C-E

blijvend

dak_schuin_fundering	$0.87 * 1.75$	=	1.52 kN/m ¹
dak_plat_beton	$5.00 * 1.10$	=	5.50 kN/m ¹
verdiepingsvloer_D200	$6.15 * (2.60+1.10)$	=	22.76 kN/m ¹
metselwerk_D214mm	$4.00 * 6.40$	=	25.60 kN/m ¹

Totaal = 55.38 kN/m¹

opgelegd

verdiepingsvloer_D200	$5.00 * (2.60+1.10)$	=	18.50 kN/m ¹
-----------------------	----------------------	---	-------------------------

wind / sneeuw

sneeuw_aang_gem	$1.12 * (1.75+1.10)$	=	3.19 kN/m ¹
-----------------	----------------------	---	------------------------

q _{Ed}	$1.2 * 55.38 + 1.5 * 18.50$	=	94.21 kN/m ¹
-----------------	-----------------------------	---	-------------------------

Balk as 5

blijvend

dak_plat_beton	$5.00 * 1.10$	=	5.50 kN/m ¹
dak_plat_hout	$0.90 * 1.40$	=	1.26 kN/m ¹
verdiepingsvloer_D200	$6.15 * 1.10$	=	6.77 kN/m ¹
metselwerk_D120mm	$2.40 * 6.40$	=	15.36 kN/m ¹

Totaal = 28.89 kN/m¹

opgelegd

verdiepingsvloer_D200	$5.00 * 1.10$	=	5.50 kN/m ¹
-----------------------	---------------	---	------------------------

wind / sneeuw

sneeuw_aang_gem	$1.12 * 2.50$	=	2.80 kN/m ¹
-----------------	---------------	---	------------------------

q _{Ed}	$1.2 * 28.89 + 1.5 * 5.50$	=	42.92 kN/m ¹
-----------------	----------------------------	---	-------------------------

Poer as B/2

blijvend

uit tussenkolom	$41.77 + 133.5$	=	175.27 kN
-----------------	-----------------	---	-----------

opgelegd

uit tussenkolom	102.65	=	102.65 kN
-----------------	--------	---	-----------

wind / sneeuw

uit tussenkolom	31.91	=	31.91 kN
-----------------	-------	---	----------

N_{Ed}

e.g.	175.27	*1.2	=	210.32 kN
------	--------	------	---	-----------

v.b.	102.65	*1.5	=	153.98 kN
------	--------	------	---	-----------

Totaal = 364.30 kN

Poer as C/2

blijvend

e.g._uit_as_BenC	23.77	=	23.77 kN
dak_schuin_fundering	$0.87 * 5.25*0.5 * 5.50*0.5$	=	6.28 kN
uit dakligger	24.86	=	24.86 kN
uit_ligger_as_2	45.98	=	45.98 kN

Totaal = 100.89 kN

opgelegd

uit_ligger_as_2	35.75	=	35.75 kN
-----------------	-------	---	----------

<i>wind / sneeuw</i>				
sn uit_as_BenC	8.74			= 8.74 kN
sneeuw_aang_gem	$1.12 * 5.25 * 0.5 * 5.50 * 0.5$			= 8.09 kN
uit dakligger	20.88			= 20.88 kN
			Totaal	= 37.71 kN
N_{Ed}				
e.g.	100.89	*1.2		= 121.07 kN
v.b.	35.75	*1.5	*0.4	= 21.45 kN
v.b.	37.71	*1.5		= 56.57 kN
			Totaal	= 199.09 kN
<u>Poer as B/3</u>				
<i>blijvend</i>				
e.g.uit_as_2/A-B	87.52			= 87.52 kN
e.g.uit_as_2/B-C	45.98			= 45.98 kN
			Totaal	= 133.50 kN
<i>opgelegd</i>				
v.b.uit_as_2/A-B	68.91			= 68.91 kN
v.b.uit_as_2/B-C	35.75			= 35.75 kN
			Totaal	= 104.66 kN
N_{Ed}				
e.g.	133.50	*1.2		= 160.20 kN
v.b.	104.66	*1.5		= 156.99 kN
			Totaal	= 317.19 kN

5.2 Berekening stroken

Wapening poeren wordt berekend in paragraaf 5.3 Berekening poeren
In de doorsneden wordt de invloed op de begane grondvloer bepaald.

Stroken worden berekend met beddingsconstante k_{stroken} 2100 kN/m³ en k_{poeren} 9000 kN/m³ overeenkomend met het grondmechanisch advies.

Daarnaast wordt de invloed van de beddingsconstante met factor x1.3 en /1.3 bepaald om de gevoeligheid te controleren. Strook as D is berekend met de situatie een lage beddingsconstante poer en ook de situatie met een lage beddingsconstante strook. Invloed is slechts beperkt. De laatste situatie is in elk geval niet maatgevend waardoor deze situatie achterwege is gelaten bij de overige doorsneden.

5.2.1 Doorsnede as D

Technosoft Liggers release 6.83a

18 dec 2025

Project.....: 10745
Onderdeel....: Doorsnede as D
Dimensies....: kN/m/rad
Bestand.....: N:\Order\10000\10700\10745\berekeningen en schetsen\bgg
 dsn as D.dlw

Betrouwbaarheidsklasse : 2 Referentieperiode : 50
Herverdelen van momenten : nee Maximale deellengte : 0.500
Ouderdom bij belasten : 28 Relatieve vochtigheid : 50%
Doorbuigingen(beton) zijn dmv gecorrigeerde stijfheden berekend.

Fysisch lineair : Er is gerekend met de e-modulus uit de materiaaltabel.
Fys.NLE.kort : Er is gerekend met een gecorrigeerde e-modulus (korte duur).
Deze e-mod. is berekend mbv de krachten uit de fysisch lineair berekening.

Toegepaste normen volgens Eurocode met Nederlandse NB

Belastingen	NEN-EN 1990:2002	C2:2010,A1:2019	NB:2019 (nl)
	NEN-EN 1991-1-1:2002	C1/C11:2019	NB:2019 (nl)
Beton	NEN-EN 1992-1-1:2011 (nl)	C2/A1:2020 (nl)	NB:2016 (nl)



LIGGER:basis bedding

GEOMETRIE

Ligger:basis bedding

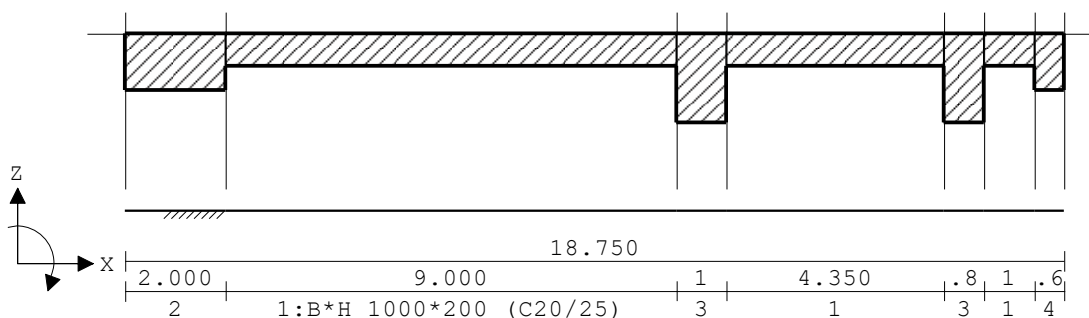

VELDLENGTEN

Ligger:basis bedding

Veld	Vanaf	Tot	Lengte
1	0.000	18.750	18.750

MATERIALEN

Mt	Kwaliteit	E-modulus [N/mm ²]	S.G.	Pois.	Uitz. coëff
1	C20/25	29962	25.0	0.20	1.0000e-05

MATERIALEN vervolg

Mt	Kwaliteit	Cement	Kruipfac.
1	C20/25	N	3.01

PROFIELEN [mm]

Prof.	Omschrijving	Materiaal	Oppervlak	Traagheid	Vormf.
1	B*H 1000*200	1:C20/25	2.0000e+05	6.6667e+08	0.00
2	B*H 2000*350	1:C20/25	7.0000e+05	7.1458e+09	0.00
3	B*H 1000*550	1:C20/25	5.5000e+05	1.3865e+10	0.00
4	B*H 1000*350	1:C20/25	3.5000e+05	3.5729e+09	0.00

PROFIELEN vervolg [mm]

Prof.	Staaftype	Breedte	Hoogte	e	Type	b1	h1	b2	h2
1	0:Normaal	1000	200	100.0	0:RH				
2	0:Normaal	2000	350	175.0	0:RH				
3	0:Normaal	1000	550	275.0	0:RH				
4	0:Normaal	1000	350	175.0	0:RH				

DOORSNEDEN

Ligger:basis bedding

sector	Vanaf	Tot	Lengte	Profiel begin	z-begin	Profiel eind	z-eind
1	0.000	2.000	2.000	2:B*H 2000*350	0.000	2:B*H 2000*350	0.000
2	2.000	11.000	9.000	1:B*H 1000*200	0.000	1:B*H 1000*200	0.000
3	11.000	12.000	1.000	3:B*H 1000*550	0.000	3:B*H 1000*550	0.000
4	12.000	16.350	4.350	1:B*H 1000*200	0.000	1:B*H 1000*200	0.000
5	16.350	17.150	0.800	3:B*H 1000*550	0.000	3:B*H 1000*550	0.000
6	17.150	18.150	1.000	1:B*H 1000*200	0.000	1:B*H 1000*200	0.000
7	18.150	18.750	0.600	4:B*H 1000*350	0.000	4:B*H 1000*350	0.000

sector	Vanaf	Tot	Lengte	Eindcode	Bedding	Br. [mm]
1	0.000	2.000	2.000	1:Vast	9000	2000
2	2.000	11.000	9.000	1:Vast	2100	1000
3	11.000	12.000	1.000	1:Vast	9000	1000
4	12.000	16.350	4.350	1:Vast	2100	1000
5	16.350	17.150	0.800	1:Vast	9000	1000
6	17.150	18.150	1.000	1:Vast	2100	1000
7	18.150	18.750	0.600	1:Vast	9000	1000

PROFIELVORMEN [mm]

1 B*H 1000*200

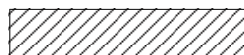

2 B*H 2000*350

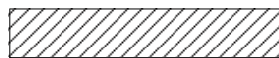

3 B*H 1000*550



4 B*H 1000*350

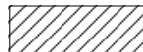

BELASTINGGEVALLEN

B.G.	Omschrijving	Belast/onbelast	Ψ_0	Ψ_1	Ψ_2	e.g.
1	Permanent	2:Permanent EN1991				-1.00
2	Veranderlijk	1:Schaakbord EN1991	0.60	0.70	0.60	0.00
3	Sneeuw	0:Alles tegelijk	0.00	0.20	0.00	0.00

BELASTINGGEVALLEN

B.G.	Omschrijving	Type
1	Permanent	1 Permanente belasting
2	Veranderlijk	2 Ver. bel. pers. ed. (q_k)
3	Sneeuw	22 Sneeuw A

VELDBELASTINGEN

Ligger:basis bedding B.G:1 Permanent

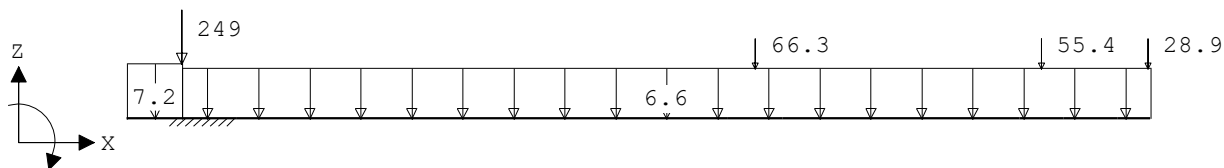

VELDBELASTINGEN

Ligger:basis bedding B.G:1 Permanent

Last Ref.	Type	Omschrijving	$q_1/p/m$	q_2	psi	Afstand	Lengte
1	1:q-last		-7.200	-7.200		0.000	1.000
2	1:q-last		-6.600	-6.600		1.000	17.750
3	8:Puntlast		-249.000			1.000	
4	8:Puntlast		-66.300			11.500	
5	8:Puntlast		-55.400			16.750	
6	8:Puntlast		-28.900			18.700	

VELDBELASTINGEN

Ligger:basis bedding B.G:2 Veranderlijk

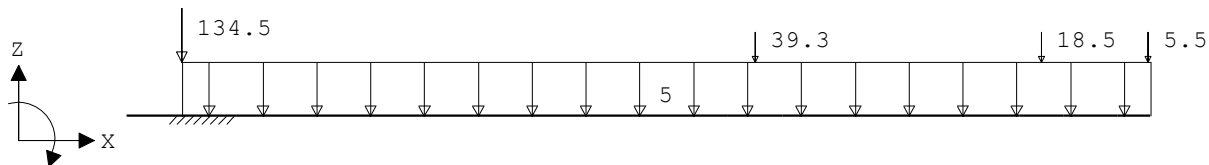

VELDBELASTINGEN

Ligger:basis bedding B.G:2 Veranderlijk

Last Ref.	Type	Omschrijving	$q_1/p/m$	q_2	psi	Afstand	Lengte
1	1:q-last		-5.000	-5.000		1.000	17.750
2	8:Puntlast		-134.500			1.000	
3	8:Puntlast		-39.300			11.500	
4	8:Puntlast		-18.500			16.750	
5	8:Puntlast		-5.500			18.700	

VELDBELASTINGEN

Ligger:basis bedding B.G:3 Sneeuw

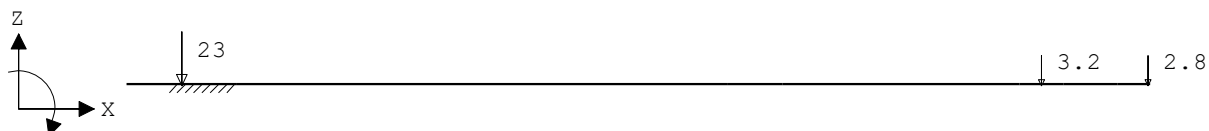

VELDBELASTINGEN

Ligger:basis bedding B.G:3 Sneeuw

Last Ref.	Type	Omschrijving	q1/p/m	q2 psi	Afstand	Lengte
1	8:Puntlast		-23.000		1.000	
2	8:Puntlast		-3.200		16.750	
3	8:Puntlast		-2.800		18.700	

BELASTINGCOMBINATIES

BC Type	BG Gen. Factor	BG Gen. Factor	BG Gen. Factor	BG Gen. Factor	BG Gen. Factor	BG Gen. Factor
1 Fund.	1 Perm	1.35				
2 Fund.	1 Perm	1.35	2 psi0	1.50		
3 Fund.	1 Perm	1.20	2 Extr	1.50		
4 Fund.	1 Perm	1.20	3 Extr	1.50		
5 Fund.	1 Perm	1.20	3 Extr	1.50	2 psi0	1.50
6 Fund.	1 Perm	0.90				
7 Fund.	1 Perm	0.90	2 psi0	1.50		
8 Fund.	1 Perm	0.90	2 Extr	1.50		
9 Fund.	1 Perm	0.90	3 Extr	1.50		
10 Fund.	1 Perm	0.90	3 Extr	1.50	2 psi0	1.50
11 Kar.	1 Perm	1.00	2 Extr	1.00		
12 Kar.	1 Perm	1.00	3 Extr	1.00		
13 Kar.	1 Perm	1.00	3 Extr	1.00	2 psi0	1.00
14 Freq.	1 Perm	1.00				
15 Freq.	1 Perm	1.00	2 psi1	1.00		
16 Freq.	1 Perm	1.00	3 psi1	1.00		
17 Freq.	1 Perm	1.00	3 psi1	1.00	2 psi2	1.00
18 Quas.	1 Perm	1.00				
19 Quas.	1 Perm	1.00	2 psi2	1.00		
20 Blij.	1 Perm	1.00				

GUNSTIGE WERKING PERMANENTE BELASTINGEN

BC Velden met gunstige werking
1 Geen
2 Geen
3 Geen
4 Geen
5 Geen
6 Alle velden de factor:0.90
7 Alle velden de factor:0.90
8 Alle velden de factor:0.90
9 Alle velden de factor:0.90
10 Alle velden de factor:0.90

OMHULLENDE VAN DE FUNDAMENTELE COMBINATIES

MOMENTEN Fysisch lineair

Ligger:basis bedding Fundamentele combinatie

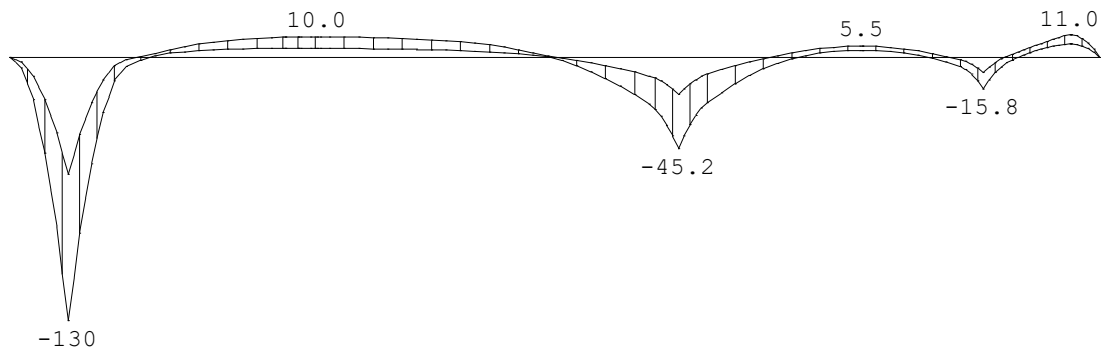

DWARSKRACHTEN Fysisch lineair

Ligger:basis bedding Fundamentele combinatie

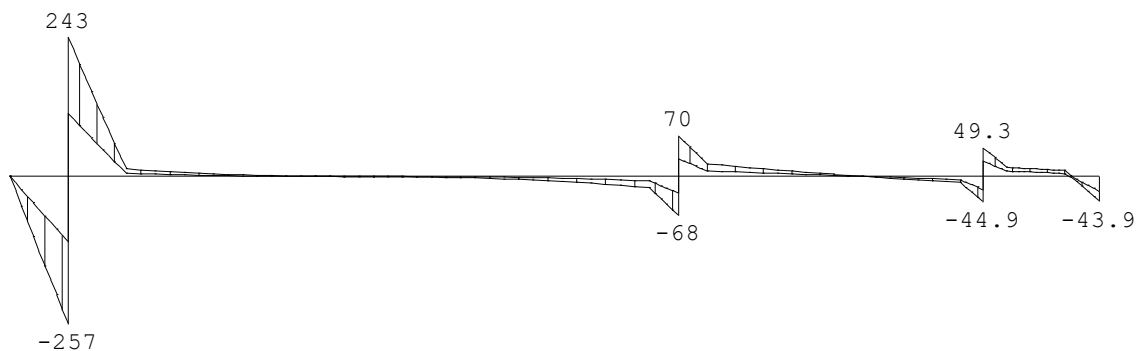

VELDWAARDEN Fysisch lineair

Ligger:basis bedding Fundamentele combinatie

Veld	Pos.	Grondspan. [kN/m2]		Dwarskr		Moment	
		min.	max.	min.	max.	min.	max.
1	0.000	70.36	148.07	0.00	0.00	0.00	0.00
1	1.000			-257.69	-114.18	-130.34	-57.82
1	1.000			109.92	242.86	-130.34	-57.82
1	2.000	60.24	127.07	5.32	12.92	-4.45	-1.15
1	2.000	60.24	127.07	5.32	12.92	-4.45	-1.15
1	2.229						0.00
1	2.422					0.00	
1	4.695			0.00			
1	4.962					4.37	
1	5.292						10.00
1	5.354				0.00		
1	6.000	10.65	22.06				
1	9.282					0.00	
1	9.372						0.00
1	11.000	59.47	127.76	-20.14	-8.21	-23.21	-9.29
1	11.000	59.47	127.76	-20.14	-8.21	-23.21	-9.29
1	11.500			-68.35	-28.95	-45.31	-18.56
1	11.500			30.54	70.16	-45.31	-18.56
1	12.000	60.68	129.90	9.41	21.40	-22.40	-8.45
1	12.000	60.68	129.90	9.41	21.40	-22.40	-8.45

VELDWAARDEN Fysisch lineair

Ligger:basis bedding Fundamentele combinatie

Veld	Pos.	Grondspan. [kN/m ²]		Dwarskr		Moment	
		min.	max.	min.	max.	min.	max.
1	12.242	14.20	30.35				
1	13.118						0.00
1	13.587					0.00	
1	14.417	13.81					
1	14.620			0.00			
1	14.631					3.33	
1	14.658						5.49
1	14.678				0.00		
1	15.798					0.00	
1	16.148						0.00
1	16.350	61.17	117.68	-10.79	-6.11	-4.66	-1.27
1	16.350	61.17	117.68	-10.79	-6.11	-4.66	-1.27
1	16.750			-44.94	-23.36	-15.82	-7.68
1	16.750			26.50	49.29	-15.82	-7.68
1	17.136						0.00
1	17.150	62.30	116.03	9.01	15.60	-2.87	0.18
1	17.150	62.30	116.03	9.01	15.60	-2.87	0.18
1	17.374					0.00	
1	18.150	64.16	114.30	4.59	10.06	6.33	10.56
1	18.150	64.16	114.30	4.59	10.06	6.33	10.56
1	18.229			0.00			
1	18.250					6.55	10.97
1	18.270				0.00		
1	18.450		114.23				
1	18.700			-39.50	-23.41		
1	18.750	65.95	114.70	-43.97	-26.01	0.00	0.00

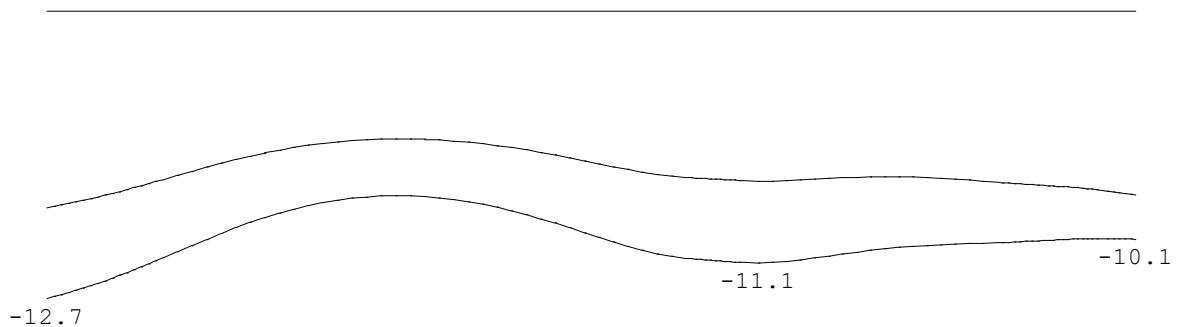
OMHULLENDE VAN DE KARAKTERISTIEKE COMBINATIES**VERPLAATSINGEN** [mm] Fys.NLE.kort Ligger:basis bedding Karakteristieke combinatie

N.B. In deze verplaatsingen is de kruipvervorming (w2) niet verwerkt!

PROFIELGEGEVENS Vloer

[N] [mm]

t.b.v. profiel:1 B*H 1000*200

Algemeen

Materiaal : C20/25

Doorsnede			
breedte :	1000	hoogte :	200
Fictieve dikte :			zwaartepunt tov onderkant : 100
			200.0
Betonkwaliteit element :	C20/25	Kruipcoëf. :	3.010
Staal kwaliteit hoofdwapening :	500	ϵ_{uk} :	2.50
Staal kwaliteit beugels :	500		
Betondekking			
		Boven	Onder
Milieu :		XC1	XC3
Hoofdwapening :		1ste laag	1ste laag
Nominale dekking :		15	30
Toegepaste dekking :		25	30
Beugel / Verdeelwapening :		2de laag	2de laag
Nominale dekking :		15	30
Toegepaste dekking :		33	38
Wapening			
		Boven	Onder
Basiswapening :		8-100	8-100
Hoofdwapening laag :		1	1
Diameter verdeelwapening :		8.0	8.0
Dwarskrachtwapening			
Min. hoek betondrukdiagonaal θ :	21.8	z berekenen via:	MRd

PROFIELGEGEVENS Vloer [N] [mm] t.b.v. profiel:2 B*H 2000*350

Algemeen			
Materiaal :	C20/25		
Doorsnede			
breedte :	2000	hoogte :	350
Fictieve dikte :			zwaartepunt tov onderkant : 175
			350.0
Betonkwaliteit element :	C20/25	Kruipcoëf. :	3.010
Staal kwaliteit hoofdwapening :	500	ϵ_{uk} :	2.50
Staal kwaliteit beugels :	500		
Betondekking			
		Boven	Onder
Milieu :		XC1	XC3
Hoofdwapening :		1ste laag	1ste laag
Nominale dekking :		15	30
Toegepaste dekking :		25	40
Beugel / Verdeelwapening :		2de laag	2de laag
Nominale dekking :		15	30
Toegepaste dekking :		33	50
Wapening			
		Boven	Onder
Basiswapening :		8-100	10-100
Hoofdwapening laag :		1	1
Diameter verdeelwapening :		10.0	10.0
Dwarskrachtwapening			
Min. hoek betondrukdiagonaal θ :	21.8	z berekenen via:	MRd

PROFIELGEGEVENS Vloer [N] [mm] t.b.v. profiel:3 B*H 1000*550

Algemeen			
Materiaal :	C20/25		
Doorsnede			
breedte :	1000	hoogte :	550
Fictieve dikte :			zwaartepunt tov onderkant : 275
			550.0
Betonkwaliteit element :	C20/25	Kruipcoëf. :	3.010
Staal kwaliteit hoofdwapening :	500	ϵ_{uk} :	2.50
Staal kwaliteit beugels :	500		

Betondekking		Boven	Onder
Milieu	:	XC1	XC3
Hoofdwapening	:	1ste laag	1ste laag
Nominale dekking	:	15	30
Toegepaste dekking	:	25	40
Beugel / Verdeelwapening	:	2de laag	2de laag
Nominale dekking	:	15	30
Toegepaste dekking	:	33	50
Wapening		Boven	Onder
Basiswapening	:	8-100	10-150
Hoofdwapening laag	:	1	1
Diameter verdeelwapening	:	8.0	10.0
Dwarskrachtwapening			
Min. hoek betondrukdiagonaal θ	:	21.8	z berekenen via: MRd

PROFIELGEGEVENS Vloer [N] [mm] t.b.v. profiel:4 B*H 1000*350

Algemeen

Materiaal : C20/25

Doorsnede

breedte : 1000 hoogte : 350 zwaartepunt tov onderkant : 175
 Fictieve dikte : 350.0

Betonkwaliteit element	:	C20/25	Kruipcoëf.	:	3.010
Staalkwaliteit hoofdwapening	:	500	ϵ_{uk}	:	2.50
Staalkwaliteit beugels	:	500			

Betondekking		Boven	Onder
Milieu	:	XC1	XC3
Hoofdwapening	:	1ste laag	1ste laag
Nominale dekking	:	15	30
Toegepaste dekking	:	25	40
Beugel / Verdeelwapening	:	2de laag	2de laag
Nominale dekking	:	15	30
Toegepaste dekking	:	33	50

Wapening		Boven	Onder
Basiswapening	:	8-100	10-150
Hoofdwapening laag	:	1	1
Diameter verdeelwapening	:	8.0	10.0

Dwarskrachtwapening
 Min. hoek betondrukdiagonaal θ : 21.8 z berekenen via: MRd

Hoofdwapening Fysisch lineair Ligger:basis bedding Fundamentele combinatie

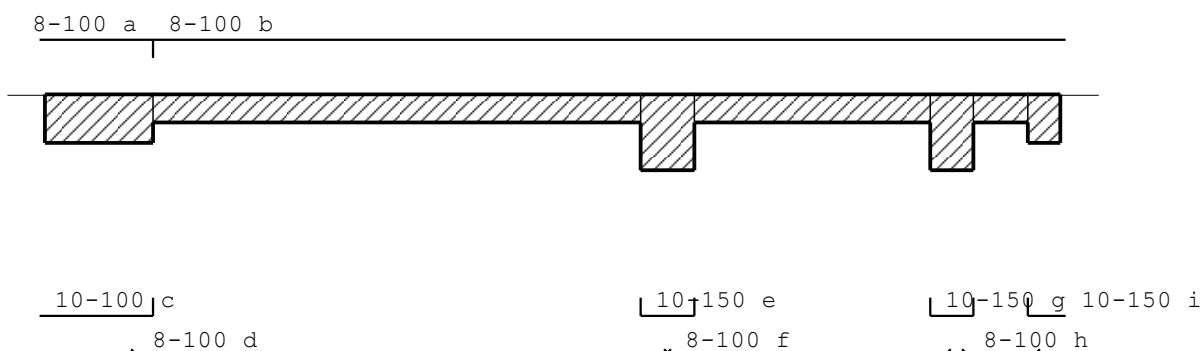

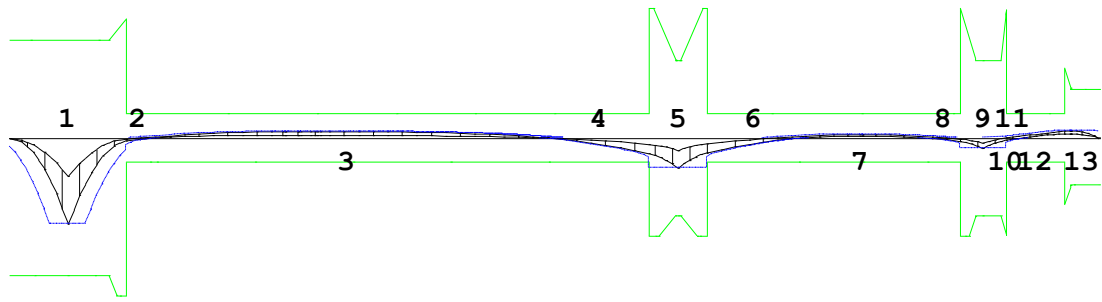

Hoofdwapening

Ligger:basis bedding

Geb.	Pos. [mm]	M _{E,d} [kNm]	M _{R,d} [kNm]	z [mm]	B/O	A _b [mm ²]	A _a [mm ²]	Basiswapening +Bijlegwapening	Opm.
1	1000	-130.34	-207.40	290	Ond	971	1572	10-100	
2	2000	-10.24	-36.13	131	Ond	177*	503	8-100	54
3	5292	10.00	37.72	124	Bov	177*	503	8-100	54
4	11000	-27.99	-36.13	131	Ond	388	503	8-100	
5	11500	-45.31	-117.27	493	Ond	402*	524	10-150	54
6	12000	-27.41	-36.13	131	Ond	380	503	8-100	
7	14658	5.49	37.72	124	Bov	177*	503	8-100	54
8	16350	-7.73	-36.13	131	Ond	177*	503	8-100	54
9	16750	-15.82	-117.27	493	Ond	402*	524	10-150	54
10	17150	5.91	196.82	434	Bov	402*	503	8-100	54
11	17150	-6.70	-36.13	131	Ond	177*	503	8-100	54
12	18150	10.93	37.72	124	Bov	180*	503	8-100	1
13	18250	10.97	75.65	225	Bov	299*	503	8-100	54

Opmerkingen

[1] * = Eisen met betrekking tot minimum wapening zijn toegepast, zie nationale bijlage art. 9.2.1.1(1).

[54] * = Eisen met betrekking tot minimum wapening ten behoeve van gecontroleerde scheurvorming zijn toegepast volgens art. 7.3.2.

[93] De wapening bij de doorsnede overgang is niet getoetst vlg. NEN-EN 1992-1-1 art.9.9.

Scheurvorming volgens artikel 7.3.4

Ligger:basis bedding

Geb.	Pos. [mm]	Zijde	M _{E, freq} [kNm]	S _{r, max} [mm]	ε _{sm} -ε _{cm} [%]	w _k [mm]	k _x	w _{max} [mm]	U.C.	Opm.
1	5292	Bov	6.79	237	0.251	0.060	1.67	0.667	0.09	
1	14658	Bov	3.90	237	0.145	0.034	1.67	0.667	0.05	
1	18150	Bov	8.06	237	0.298	0.071	1.67	0.667	0.11	
1	18250	Bov	8.11	272	0.156	0.042	1.67	0.667	0.06	
1	1000	Ond	-89.09	340	0.592	0.201	1.33	0.400	0.50	
1	2000	Ond	-6.51	255	0.249	0.064	1.00	0.300	0.21	
1	11000	Ond	-18.56	255	0.711	0.181	1.00	0.300	0.60	
1	11116	Ond	-30.31	302	0.335	0.101	1.33	0.400	0.25	

Schuifspanningen

Ligger:basis bedding

Geb.	Vanaf [mm]	Tot [mm]	θ [°]	V _{E,d} [kN]	V _{E,d} < V _{R,d} < V _{R,d, max} [N/mm ²]	V _{o,pg} [N/mm ²]	Opm.
1	0	850	21.8	219	0.36	0.41	71
2	850	1150	21.8	258	0.42	0.40	0.42 71
3	1150	2000	21.8	206	0.34	0.41	71
4	2000	11000	21.8	20	0.12	0.50	71
5	11000	12000	21.8	70	0.14	0.28	71
6	12000	16350	21.8	21	0.13	0.50	71
7	16350	17150	21.8	49	0.10	0.28	71
8	17150	18150	21.8	16	0.09	0.56	71

Schuifspanningen

Ligger:basis bedding

Geb.	Vanaf [mm]	Tot [mm]	θ [°]	V_{Ed} [kN]	$V_{Ed} < V_{Rd} < V_{Rd, max}$ -----[N/mm ²]-----	V_{opg} [N/mm ²]	Opm.	
9	18150	18750	21.8	44	0.14	0.36	1.78	71

Opmerkingen

[71] Er wordt voor platen geen minimale dwarskrachtwapening volgens art. 9.3.2 toegepast. Uitgangspunt hiervoor is dat er herverdeling van belastingen in dwarsrichting mogelijk is (zie art. 6.2.1(4)).

LIGGER:lage poer bedding

GEOMETRIE

Ligger:lage poer bedding

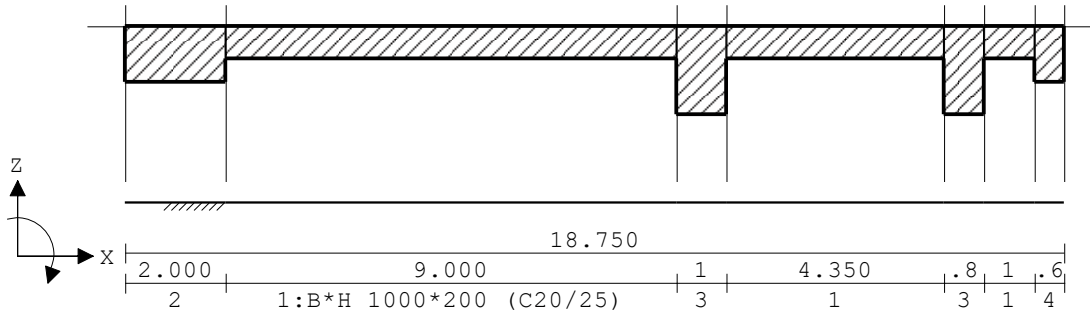

VELDLENGTEN

Ligger:lage poer bedding

Veld	Vanaf	Tot	Lengte
1	0.000	18.750	18.750

DOORSNEDEN

Ligger:lage poer bedding

sector	Vanaf	Tot	Lengte	Profiel begin	z-begin	Profiel eind	z-eind
1	0.000	2.000	2.000	2:B*H 2000*350	0.000	2:B*H 2000*350	0.000
2	2.000	11.000	9.000	1:B*H 1000*200	0.000	1:B*H 1000*200	0.000
3	11.000	12.000	1.000	3:B*H 1000*550	0.000	3:B*H 1000*550	0.000
4	12.000	16.350	4.350	1:B*H 1000*200	0.000	1:B*H 1000*200	0.000
5	16.350	17.150	0.800	3:B*H 1000*550	0.000	3:B*H 1000*550	0.000
6	17.150	18.150	1.000	1:B*H 1000*200	0.000	1:B*H 1000*200	0.000
7	18.150	18.750	0.600	4:B*H 1000*350	0.000	4:B*H 1000*350	0.000

sector	Vanaf	Tot	Lengte	Eindcode	Bedding	Br. [mm]
1	0.000	2.000	2.000	1:Vast	6900	2000
2	2.000	11.000	9.000	1:Vast	2750	1000
3	11.000	12.000	1.000	1:Vast	6900	1000
4	12.000	16.350	4.350	1:Vast	2100	1000
5	16.350	17.150	0.800	1:Vast	6900	1000
6	17.150	18.150	1.000	1:Vast	2100	1000
7	18.150	18.750	0.600	1:Vast	6900	1000

PROFIELVORMEN [mm]

1 B*H 1000*200

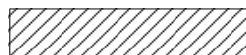

2 B*H 2000*350

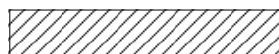

PROFIELVORMEN [mm]

3 B*H 1000*550



4 B*H 1000*350

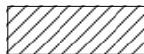

VELDBELASTINGEN

Ligger:lage poer bedding B.G:1 Permanent

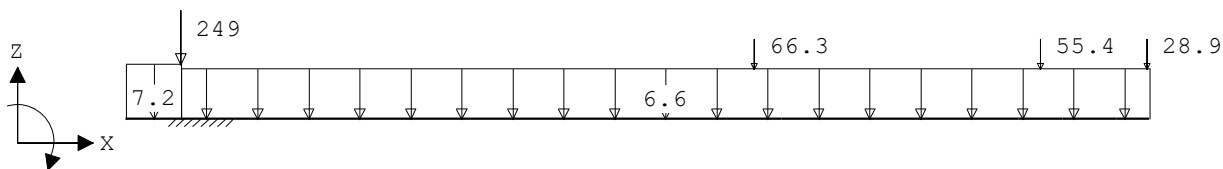

VELDBELASTINGEN

Ligger:lage poer bedding B.G:1 Permanent

Last Ref.	Type	Omschrijving	q1/p/m	q2 psi	Afstand	Lengte
1	1:q-last		-7.200	-7.200	0.000	1.000
2	1:q-last		-6.600	-6.600	1.000	17.750
3	8:Puntlast		-249.000		1.000	
4	8:Puntlast		-66.300		11.500	
5	8:Puntlast		-55.400		16.750	
6	8:Puntlast		-28.900		18.700	

VELDBELASTINGEN

Ligger:lage poer bedding B.G:2 Veranderlijk

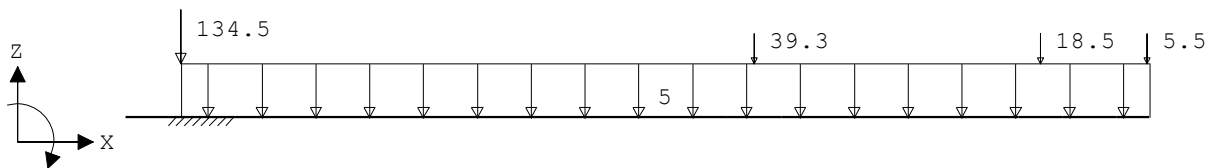

VELDBELASTINGEN

Ligger:lage poer bedding B.G:2 Veranderlijk

Last Ref.	Type	Omschrijving	q1/p/m	q2 psi	Afstand	Lengte
1	1:q-last		-5.000	-5.000	1.000	17.750
2	8:Puntlast		-134.500		1.000	
3	8:Puntlast		-39.300		11.500	
4	8:Puntlast		-18.500		16.750	
5	8:Puntlast		-5.500		18.700	

VELDBELASTINGEN

Ligger:lage poer bedding B.G:3 Sneeuw



VELDBELASTINGEN

Ligger:lage poer bedding B.G:3 Sneeuw

Last Ref.	Type	Omschrijving	q1/p/m	q2	psi	Afstand	Lengte
1	8:Puntlast		-23.000			1.000	
2	8:Puntlast		-3.200			16.750	
3	8:Puntlast		-2.800			18.700	

OMHULLENDE VAN DE FUNDAMENTELE COMBINATIES

MOMENTEN Fysisch lineair

Ligger:lage poer bedding Fundamentele combinatie

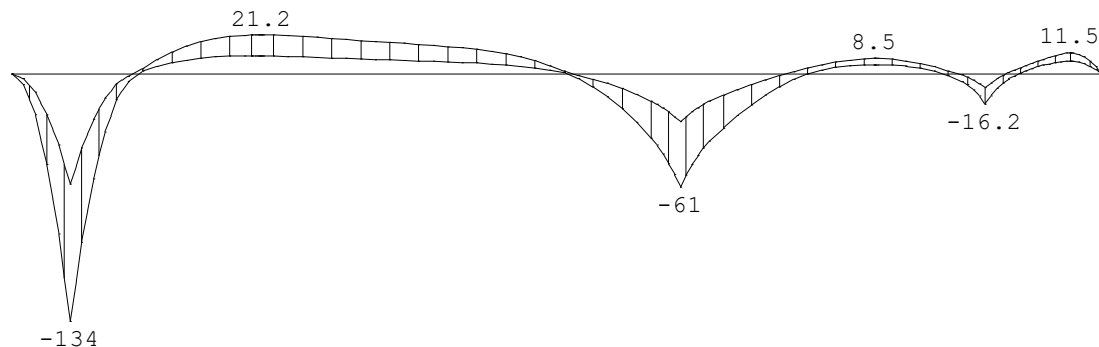

DWARSKRACHTEN Fysisch lineair

Ligger:lage poer bedding Fundamentele combinatie

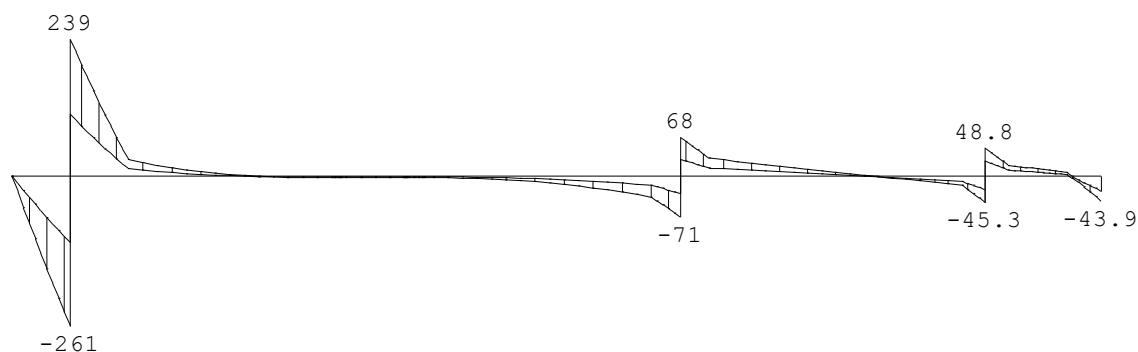

VELDWAARDEN Fysisch lineair

Ligger:lage poer bedding Fundamentele combinatie

Veld	Pos.	Grondspan. [kN/m2]		Dwarskr		Moment	
		min.	max.	min.	max.	min.	max.
1	0.000	74.21	156.19	0.00	0.00	0.00	0.00
1	1.000			-261.56	-116.02	-134.34	-59.72
1	1.000			108.08	238.99	-134.34	-59.72
1	2.000	52.65	111.11	13.07	29.25	-4.17	-1.02
1	2.000	52.65	111.11	13.07	29.25	-4.17	-1.02
1	2.065						0.00
1	2.174					0.00	
1	4.126			0.00			
1	4.188					9.90	
1	4.308						21.24
1	4.339				0.00		
1	5.532				-1.22		
1	5.627			-2.58			
1	6.250	10.09	21.04				
1	6.915			-2.19	-0.97		
1	9.570					0.00	

VELDWAARDEN Fysisch lineair

Ligger:lage poer bedding Fundamentele combinatie

Veld	Pos.	Grondspan. [kN/m2]		Dwarskr		Moment	
		min.	max.	min.	max.	min.	max.
1	9.671						0.00
1	11.000	46.13	99.32	-36.21	-15.59	-34.69	-14.62
1	11.000	46.13	99.32	-36.21	-15.59	-34.69	-14.62
1	11.500			-70.79	-29.94	-61.36	-25.97
1	11.500			29.48	67.72	-61.36	-25.97
1	12.000	49.51	106.13	14.22	31.43	-36.51	-14.86
1	12.000	49.51	106.13	14.22	31.43	-36.51	-14.86
1	12.725		32.90				
1	12.967	15.48					
1	13.311						0.00
1	13.703					0.00	
1	13.933	15.45					
1	14.817			0.00			
1	14.838					5.10	
1	14.850						8.47
1	14.872				0.00		
1	14.900		31.76				
1	16.030					0.00	
1	16.299						0.00
1	16.350	55.21	105.92	-15.67	-8.65	-3.99	-0.49
1	16.350	55.21	105.92	-15.67	-8.65	-3.99	-0.49
1	16.750			-45.39	-23.65	-16.20	-7.51
1	16.750			26.21	48.84	-16.20	-7.51
1	17.103						0.00
1	17.150	57.62	107.09	10.73	18.88	-2.64	0.66
1	17.150	57.62	107.09	10.73	18.88	-2.64	0.66
1	17.327					0.00	
1	18.150	61.08	108.95	2.78	7.47	6.78	11.30
1	18.150	61.08	108.95	2.78	7.47	6.78	11.30
1	18.197			0.00			
1	18.216					6.88	11.50
1	18.246				0.00		
1	18.700			-39.68	-23.52		
1	18.750	63.75	111.18	-43.97	-26.01	0.00	0.00

OMHULLENDE VAN DE KARAKTERISTIEKE COMBINATIES

VERPLAATSINGEN [mm] Fys.NLE.kortLigger:lagepoer bedding Karakteristieke combinatie

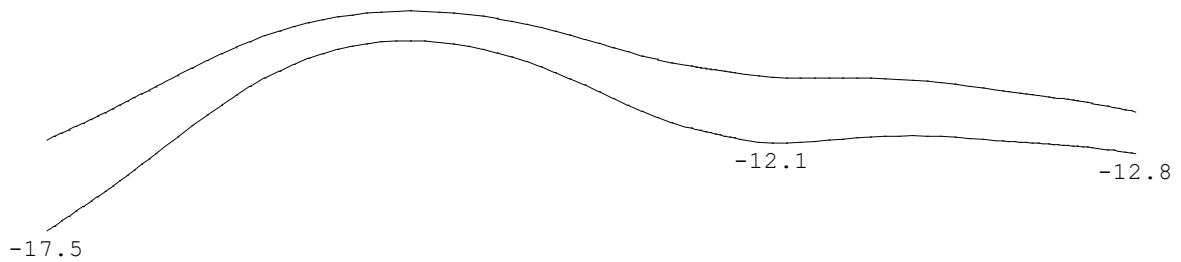

N.B. In deze verplaatsingen is de kruipvervorming (w2) niet verwerkt!

Hoofdwapening Fysisch lineair Ligger:lage poer bedding Fundamentele combinatie

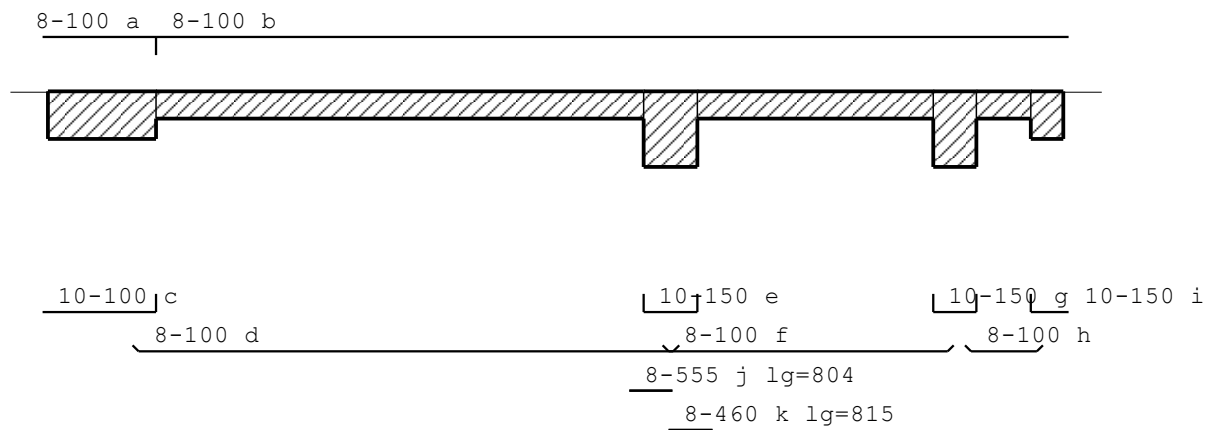

Med dekkingslijn Fysisch lineair Ligger:lage poer bedding Fundamentele combinatie

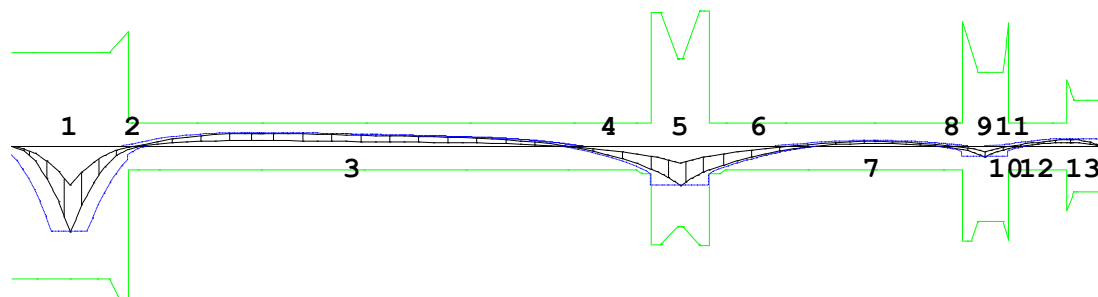

Hoofdwapening

Ligger:lage poer bedding

Geb.	Pos. [mm]	$M_{E,d}$ [kNm]	$M_{R,d}$ [kNm]	z	B/O	A_b [mm ²]	A_a [mm ²]	Basiswapening +Bijlegwapening	Opm.
1	1000	-134.34	-207.40	290	Ond	1002	1572	10-100	
2	2000	-12.17	-36.13	131	Ond	207*	503	8-100	1
3	4308	21.24	37.72	124	Bov	283	503	8-100	
4	11000	-41.71	-41.74	142	Ond	594	503	8-100	
					Ond		91	+8-555	
5	11500	-61.36	-125.43	425	Ond	402*	524	10-150	54
6	12000	-42.83	-42.90	145	Ond	612	503	8-100	
					Ond		110	+8-460	
7	14850	8.47	37.72	124	Bov	177*	503	8-100	54
8	16350	-7.70	-36.13	131	Ond	177*	503	8-100	54
9	16750	-16.20	-117.27	493	Ond	402*	524	10-150	54
10	17150	7.14	196.82	434	Bov	402*	503	8-100	54
11	17150	-6.90	-36.13	131	Ond	177*	503	8-100	54
12	18150	11.48	37.72	124	Bov	190*	503	8-100	1
13	18216	11.50	88.45	227	Bov	299*	503	8-100	54

Opmerkingen

[1] * = Eisen met betrekking tot minimum wapening zijn toegepast, zie nationale bijlage art. 9.2.1.1(1).

[54] * = Eisen met betrekking tot minimum wapening ten behoeve van gecontroleerde scheurvorming zijn toegepast volgens art. 7.3.2.

[93] **De wapening bij de doorsnede overgang is niet getoetst vlg. NEN-EN 1992-1-1 art.9.9.**

Scheurvorming volgens artikel 7.3.4

Ligger:lage poer bedding

Geb.	Pos. [mm]	Zijde	$M_{E, freq}$ [kNm]	$S_{r, max}$ [mm]	$\epsilon_{sm} - \epsilon_{cm}$ [%]	W_k [mm]	k_x	w_{max} [mm]	U.C.	Opm.
1	4308	Bov	14.74	237	0.546	0.130	1.67	0.667	0.19	
1	14850	Bov	6.15	237	0.228	0.054	1.67	0.667	0.08	
1	18150	Bov	8.50	237	0.315	0.075	1.67	0.667	0.11	
1	18216	Bov	8.51	272	0.149	0.041	1.67	0.667	0.06	
1	1000	Ond	-91.88	340	0.610	0.207	1.33	0.400	0.52	
1	2000	Ond	-7.83	255	0.300	0.077	1.00	0.300	0.26	
1	10734	Ond	-21.02	255	0.814	0.208	1.00	0.300	0.69	
1	11000	Ond	-28.06	230	1.081	0.249	1.00	0.300	0.83	

Schuifspanningen

Ligger:lage poer bedding

Geb.	Vanaf [mm]	Tot [mm]	θ [°]	V_{Ed} [kN]	$V_{Ed} < V_{Rd} < V_{Rd, max}$ [N/mm ²]	V_{opg} [N/mm ²]	Opm.	
1	0	850	21.8	224	0.37	0.41	2.42	71
2	850	1150	21.8	262	0.43	0.40	2.42	0.43 71
3	1150	2000	21.8	204	0.33	0.40	2.42	71
4	2000	11000	21.8	36	0.22	0.50	2.18	71
5	11000	12000	21.8	71	0.14	0.28	1.58	71
6	12000	16350	21.8	31	0.19	0.50	2.22	71
7	16350	17150	21.8	49	0.10	0.28	2.48	71
8	17150	18150	21.8	19	0.11	0.55	1.85	71
9	18150	18750	21.8	44	0.14	0.36	1.78	71

Schuifspanningen

Ligger:lage poer bedding

Geb.	Vanaf [mm]	Tot [mm]	θ [°]	V_{Ed} [kN]	$V_{Rd,c}$	$V_{Rd,s}$	$V_{Ed} < V_{Rd}$ [N/mm ²]	$V_{Rd} < V_{Rd,Max}$	Opm.
------	---------------	-------------	-----------------	------------------	------------	------------	---	-----------------------	------

Opmerkingen

[71] Er wordt voor platen geen minimale dwarskrachtwapening volgens art. 9.3.2 toegepast. Uitgangspunt hiervoor is dat er herverdeling van belastingen in dwarsrichting mogelijk is (zie art. 6.2.1(4)).

LIGGER:lage vloer bedding

GEOMETRIE

Ligger:lage vloer bedding

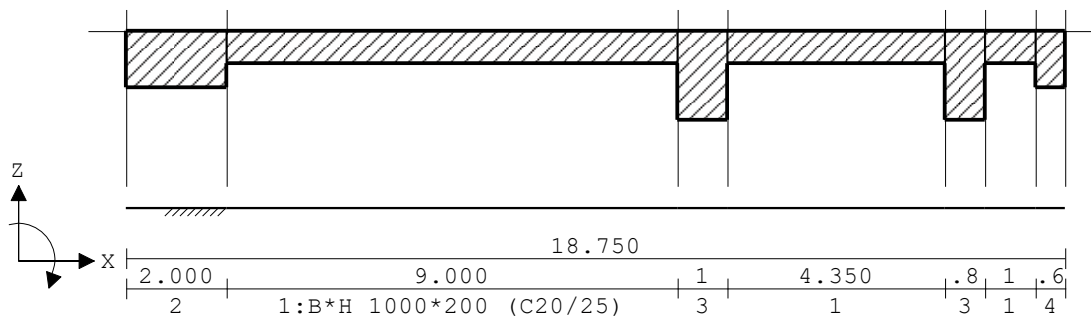

VELDLENGTEN

Ligger:lage vloer bedding

Veld	Vanaf	Tot	Lengte
1	0.000	18.750	18.750

DOORSNEDEN

Ligger:lage vloer bedding

sector	Vanaf	Tot	Lengte	Profiel begin	z-begin	Profiel eind	z-eind
1	0.000	2.000	2.000	2:B*H 2000*350	0.000	2:B*H 2000*350	0.000
2	2.000	11.000	9.000	1:B*H 1000*200	0.000	1:B*H 1000*200	0.000
3	11.000	12.000	1.000	3:B*H 1000*550	0.000	3:B*H 1000*550	0.000
4	12.000	16.350	4.350	1:B*H 1000*200	0.000	1:B*H 1000*200	0.000
5	16.350	17.150	0.800	3:B*H 1000*550	0.000	3:B*H 1000*550	0.000
6	17.150	18.150	1.000	1:B*H 1000*200	0.000	1:B*H 1000*200	0.000
7	18.150	18.750	0.600	4:B*H 1000*350	0.000	4:B*H 1000*350	0.000

sector	Vanaf	Tot	Lengte	Eindcode	Bedding	Br. [mm]
1	0.000	2.000	2.000	1:Vast	11700	2000
2	2.000	11.000	9.000	1:Vast	1600	1000
3	11.000	12.000	1.000	1:Vast	11700	1000
4	12.000	16.350	4.350	1:Vast	1600	1000
5	16.350	17.150	0.800	1:Vast	11700	1000
6	17.150	18.150	1.000	1:Vast	1600	1000
7	18.150	18.750	0.600	1:Vast	11700	1000

PROFIELVORMEN [mm]

1 B*H 1000*200

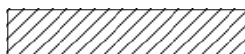

2 B*H 2000*350

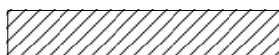

PROFIELVORMEN [mm]

3 B*H 1000*550



4 B*H 1000*350

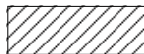

VELDBELASTINGEN

Ligger:lage vloer bedding B.G:1 Permanent

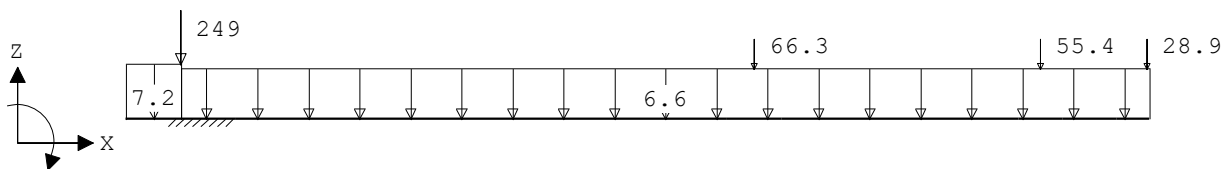

VELDBELASTINGEN

Ligger:lage vloer bedding B.G:1 Permanent

Last Ref.	Type	Omschrijving	q1/p/m	q2 psi	Afstand	Lengte
1	1:q-last		-7.200	-7.200	0.000	1.000
2	1:q-last		-6.600	-6.600	1.000	17.750
3	8:Puntlast		-249.000		1.000	
4	8:Puntlast		-66.300		11.500	
5	8:Puntlast		-55.400		16.750	
6	8:Puntlast		-28.900		18.700	

VELDBELASTINGEN

Ligger:lage vloer bedding B.G:2 Veranderlijk

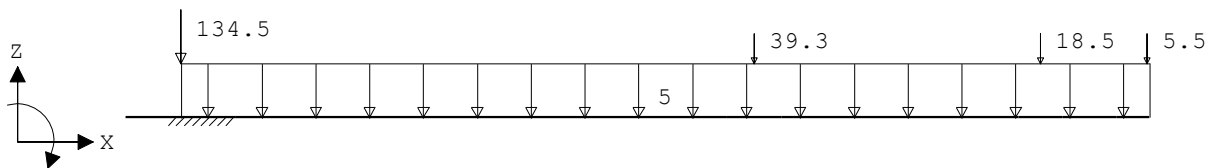

VELDBELASTINGEN

Ligger:lage vloer bedding B.G:2 Veranderlijk

Last Ref.	Type	Omschrijving	q1/p/m	q2 psi	Afstand	Lengte
1	1:q-last		-5.000	-5.000	1.000	17.750
2	8:Puntlast		-134.500		1.000	
3	8:Puntlast		-39.300		11.500	
4	8:Puntlast		-18.500		16.750	
5	8:Puntlast		-5.500		18.700	

VELDBELASTINGEN

Ligger:lage vloer bedding B.G:3 Sneeuw



VELDBELASTINGEN

Ligger:lage vloer bedding B.G:3 Sneeuw

Last Ref.	Type	Omschrijving	q1/p/m	q2	psi	Afstand	Lengte
1	8:Puntlast		-23.000			1.000	
2	8:Puntlast		-3.200			16.750	
3	8:Puntlast		-2.800			18.700	

OMHULLENDE VAN DE FUNDAMENTELE COMBINATIES

MOMENTEN Fysisch lineair

Ligger:lage vloer bedding Fundamentele combinatie

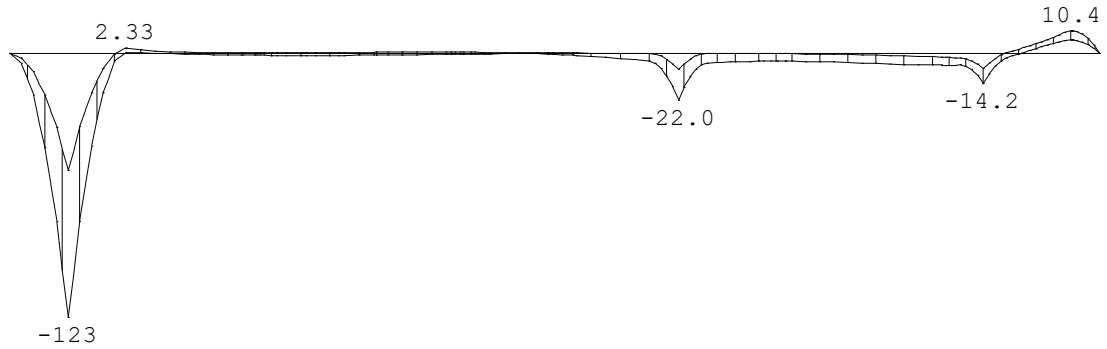

DWARSKRACHTEN Fysisch lineair

Ligger:lage vloer bedding Fundamentele combinatie

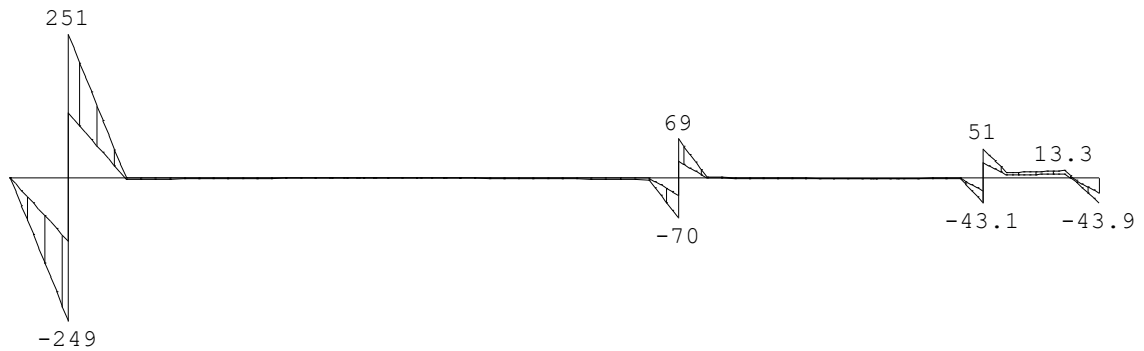

VELDWAARDEN Fysisch lineair

Ligger:lage vloer bedding Fundamentele combinatie

Veld	Pos.	Grondspan. [kN/m2]		Dwarskr		Moment	
		min.	max.	min.	max.	min.	max.
1	0.000	64.69	136.13	0.00	0.00	0.00	0.00
1	1.000			-249.69	-110.37	-123.70	-54.67
1	1.000			113.73	250.86	-123.70	-54.67
1	1.829						0.00
1	1.976					0.00	
1	1.977			0.00			
1	1.989						2.33
1	2.000	69.36	146.24	-2.75	-0.19	0.27	2.31
1	2.000	69.36	146.24	-2.75	-0.19	0.27	2.31
1	2.554					0.00	
1	3.399				0.00		
1	4.250						0.18
1	5.098					-1.07	
1	5.965				0.45		
1	6.306			0.00			
1	7.066			0.03			

VELDWAARDEN Fysisch lineair

Ligger:lage vloer bedding Fundamentele combinatie

Veld	Pos.	Grondspan. [kN/m2]		Dwarskr		Moment	
		min.	max.	min.	max.	min.	max.
1	7.248			0.00			
1	7.250						0.49
1	9.000					-0.16	0.11
1	9.061						0.11
1	9.701				0.00		
1	10.678						0.00
1	11.000	77.50	165.90	-2.99	-0.20	-3.79	-0.06
1	11.000	77.50	165.90	-2.99	-0.20	-3.79	-0.06
1	11.500			-70.01	-29.85	-22.03	-7.57
1	11.500			29.69	68.50	-22.03	-7.57
1	11.900		166.03				
1	11.997			0.00			
1	12.000	77.87	166.03	-0.17	1.48	-4.55	-0.09
1	12.000	77.87	166.03	-0.17	1.48	-4.55	-0.09
1	12.390						-0.07
1	12.725	10.67					
1	13.208					-3.70	
1	13.368				0.00		
1	14.916			-1.04			
1	15.142				-0.67		
1	15.258			-1.02			
1	16.019				0.00		
1	16.160					-5.59	
1	16.350	73.87	142.97	-1.19	0.50	-5.56	-2.14
1	16.350	73.87	142.97	-1.19	0.50	-5.56	-2.14
1	16.358				0.00		
1	16.750			-43.18	-22.49	-14.19	-7.10
1	16.750			27.37	51.05	-14.19	-7.10
1	17.138						0.00
1	17.150	71.44	133.76	5.87	9.75	-2.17	0.12
1	17.150	71.44	133.76	5.87	9.75	-2.17	0.12
1	17.406					0.00	
1	18.150	68.83	122.52	6.74	13.31	5.81	9.70
1	18.150	68.83	122.52	6.74	13.31	5.81	9.70
1	18.260			0.00			
1	18.264					6.22	
1	18.282						10.43
1	18.297				0.00		
1	18.700			-39.32	-23.30		
1	18.750	68.00	117.70	-43.97	-26.01	0.00	0.00

OMHULLENDE VAN DE KARAKTERISTIEKE COMBINATIES

VERPLAATSINGEN [mm] Fys.NLE.kortLigger:lagevloerbedding Karakteristieke combinatie

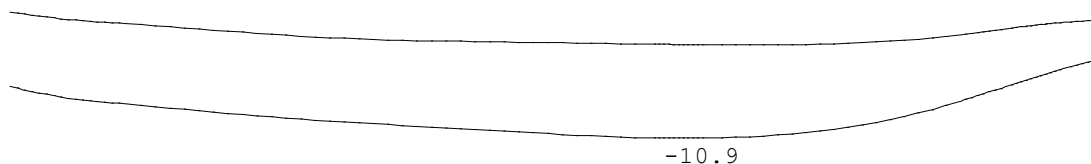

N.B. In deze verplaatsingen is de kruipvervorming (w_2) niet verwerkt!

Hoofdwapening Fysisch lineair Ligger:lage vloer bedding Fundamentele combinatie

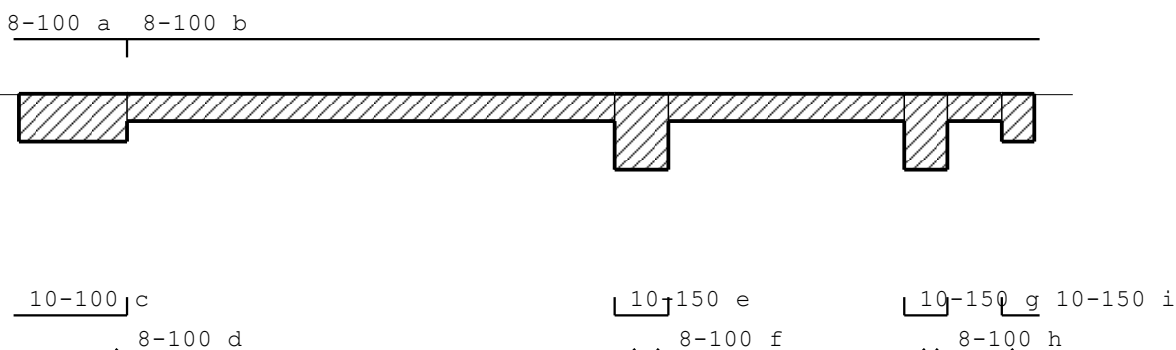

MEd dekkingslijn Fysisch lineair Ligger:lage vloer bedding Fundamentele combinatie

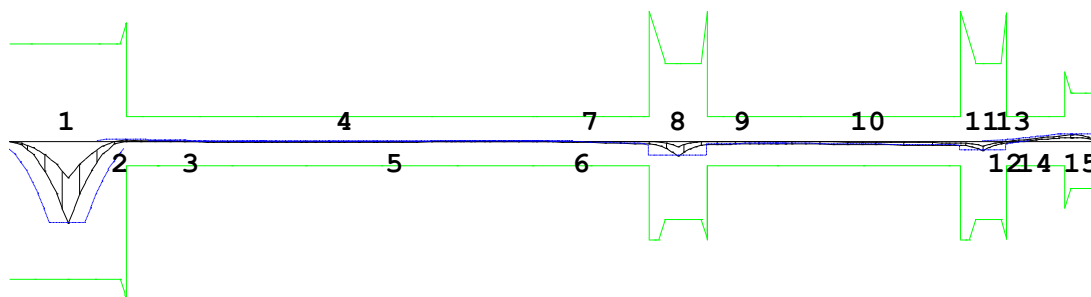

Hoofdwapening Ligger:lage vloer bedding

Geb.	Pos. [mm]	$M_{E,d}$ [kNm]	$M_{R,d}$ [kNm]	z [mm]	B/O	A_b [mm ²]	A_a [mm ²]	Basiswapening +Bijlegwapening	Opm.
1	1000	-123.70	-207.40	290	Ond	921	1572	10-100	
2	1989	2.33	177.33	218	Bov	598*	1006	8-100	54
3	2000	2.31	37.72	124	Bov	177*	503	8-100	54
4	5098	-1.07	-36.13	131	Ond	177*	503	8-100	54
5	7250	0.49	37.72	124	Bov	177*	503	8-100	54
6	9061	0.15	37.72	124	Bov	177*	503	8-100	54
7	11000	-6.28	-36.13	131	Ond	177*	503	8-100	54
8	11500	-22.03	-117.27	493	Ond	402*	524	10-150	54

Hoofdwapening

Ligger:lage vloer bedding

Geb.	Pos. [mm]	M_{Ed} [kNm]	M_{Rd} [kNm]	z [mm]	B/O	A_b [mm ²]	A_a [mm ²]	Basiswapening +Bijlegwapening	Opm.
9	12000	-4.57	-36.13	131	Ond	177*	503	8-100	54
10	16160	-5.59	-36.13	131	Ond	177*	503	8-100	54
11	16750	-14.19	-117.27	493	Ond	402*	524	10-150	54
12	17150	4.58	196.82	434	Bov	402*	503	8-100	54
13	17150	-5.25	-36.13	131	Ond	177*	503	8-100	54
14	18150	10.38	37.72	124	Bov	177*	503	8-100	54
15	18282	10.43	73.45	225	Bov	299*	503	8-100	54

Opmerkingen

[54] * = Eisen met betrekking tot minimum wapening ten behoeve van gecontroleerde scheurvorming zijn toegepast volgens art. 7.3.2.

[93] De wapening bij de doorsnede overgang is niet getoetst vlg. NEN-EN 1992-1-1 art.9.9.

Scheurvorming volgens artikel 7.3.4

Ligger:lage vloer bedding

Geb.	Pos. [mm]	Zijde	$M_{E, freq}$ [kNm]	$S_{r, max}$ [mm]	$\epsilon_{sm} - \epsilon_{cm}$ [%]	w_k [mm]	k_x	w_{max} [mm]	U.C.	Opm.
1	1829	Bov	1.71	272	0.017	0.005	1.67	0.667	0.01	
1	1900	Bov	1.71	272	0.017	0.005	1.67	0.667	0.01	
1	2000	Bov	1.71	237	0.063	0.015	1.67	0.667	0.02	
1	18150	Bov	7.70	237	0.285	0.068	1.67	0.667	0.10	
1	1000	Ond	-84.45	340	0.561	0.191	1.33	0.400	0.48	
1	5098	Ond	-0.79	255	0.030	0.008	1.00	0.300	0.03	
1	11000	Ond	-14.07	302	0.156	0.047	1.33	0.400	0.12	
1	11266	Ond	-14.07	340	0.166	0.056	1.33	0.400	0.14	

Schuifspanningen

Ligger:lage vloer bedding

Geb.	Vanaf [mm]	Tot [mm]	θ [°]	V_{Ed} [kN]	$V_{Ed} < V_{Rd} < V_{Rd, max}$ -----[N/mm ²]-----	V_{opg} [N/mm ²]	Opm.		
1	0	850	21.8	211	0.35	0.41	2.42	71	
2	850	1150	21.8	251	0.41	0.40	2.42	0.41	71
3	1150	2000	21.8	213	0.35	0.41	2.42	71	
4	2000	8900	21.8	3	0.02	0.49	1.85	71	
5	8900	11000	21.8	3	0.02	0.50	2.01	71	
6	11000	12000	21.8	70	0.14	0.28	2.48	71	
7	12000	16350	21.8	1	0.01	0.50	2.01	71	
8	16350	17150	21.8	51	0.10	0.28	2.48	71	
9	17150	18150	21.8	13	0.08	0.49	1.85	71	
10	18150	18750	21.8	44	0.14	0.36	1.78	71	

Opmerkingen

[71] Er wordt voor platen geen minimale dwarskrachtwapening volgens art. 9.3.2 toegepast. Uitgangspunt hiervoor is dat er herverdeling van belastingen in dwarsrichting mogelijk is (zie art. 6.2.1(4)).

5.2.2 Doorsnede tussen B-C

Technosoft Liggers release 6.83a

1 dec 2025

Project.....: 10745
 Onderdeel....: Doorsnede tussen as B-C
 Dimensies....: kN/m/rad
 Bestand.....: N:\Order\10000\10700\10745\berekeningen en schetsen\bgg
 dsn tussen as B-C.dlw

Betrouwbaarheidsklasse : 2 Referentieperiode : 50
 Herverdelen van momenten : nee Maximale deellengte : 0.500
 Ouderdom bij belasten : 28 Relatieve vochtigheid : 50%
 Doorbuigingen(beton) zijn dmv gecorrigeerde stijfheden berekend.

Fysisch lineair : Er is gerekend met de e-modulus uit de materiaaltabel.
 Fys.NLE.kort : Er is gerekend met een gecorrigeerde e-modulus (korte duur).
 Deze e-mod. is berekend mbv de krachten uit de fysisch lineair berekening.

Toegepaste normen volgens Eurocode met Nederlandse NB

Belastingen	NEN-EN 1990:2002	C2:2010,A1:2019	NB:2019 (nl)
	NEN-EN 1991-1-1:2002	C1/C11:2019	NB:2019 (nl)
Beton	NEN-EN 1992-1-1:2011 (nl)	C2/A1:2020 (nl)	NB:2016 (nl)



K82509

LIGGER:basis bedding

GEOMETRIE

Ligger:basis bedding

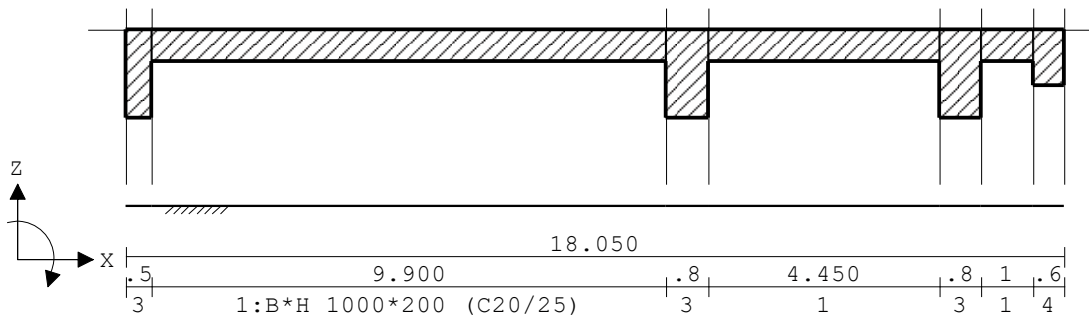

VELDLENGTEN

Ligger:basis bedding

Veld	Vanaf	Tot	Lengte
1	0.000	18.050	18.050

MATERIALEN

Mt	Kwaliteit	E-modulus [N/mm ²]	S.G.	Pois.	Uitz. coëff
1	C20/25	29962	25.0	0.20	1.0000e-05

MATERIALEN vervolg

Mt	Kwaliteit	Cement	Kruipfac.
1	C20/25	N	3.01

PROFIELEN [mm]

Prof.	Omschrijving	Materiaal	Oppervlak	Traagheid	Vormf.
1	B*H 1000*200	1:C20/25	2.0000e+05	6.6667e+08	0.00
2	B*H 2000*300	1:C20/25	6.0000e+05	4.5000e+09	0.00
3	B*H 1000*550	1:C20/25	5.5000e+05	1.3865e+10	0.00
4	B*H 1000*350	1:C20/25	3.5000e+05	3.5729e+09	0.00

PROFIELEN vervolg [mm]

Prof.	Staaftype	Breedte	Hoogte	e	Type	b1	h1	b2	h2
1	0:Normaal	1000	200	100.0	0:RH				
2	0:Normaal	2000	300	150.0	0:RH				
3	0:Normaal	1000	550	275.0	0:RH				
4	0:Normaal	1000	350	175.0	0:RH				

DOORSNEDEN

Ligger:basis bedding

sector	Vanaf	Tot	Lengte	Profiel begin	z-begin	Profiel eind	z-eind
1	0.000	0.500	0.500	3:B*H 1000*550	0.000	3:B*H 1000*550	0.000
2	0.500	10.400	9.900	1:B*H 1000*200	0.000	1:B*H 1000*200	0.000
3	10.400	11.200	0.800	3:B*H 1000*550	0.000	3:B*H 1000*550	0.000
4	11.200	15.650	4.450	1:B*H 1000*200	0.000	1:B*H 1000*200	0.000
5	15.650	16.450	0.800	3:B*H 1000*550	0.000	3:B*H 1000*550	0.000
6	16.450	17.450	1.000	1:B*H 1000*200	0.000	1:B*H 1000*200	0.000
7	17.450	18.050	0.600	4:B*H 1000*350	0.000	4:B*H 1000*350	0.000

sector	Vanaf	Tot	Lengte	Eindcode	Bedding	Br. [mm]
1	0.000	0.500	0.500	1:Vast	9000	1000
2	0.500	10.400	9.900	1:Vast	2100	1000
3	10.400	11.200	0.800	1:Vast	9000	1000
4	11.200	15.650	4.450	1:Vast	2100	1000
5	15.650	16.450	0.800	1:Vast	9000	1000
6	16.450	17.450	1.000	1:Vast	2100	1000
7	17.450	18.050	0.600	1:Vast	9000	1000

PROFIELVORMEN [mm]

1 B*H 1000*200

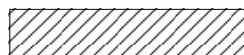

2 B*H 2000*300

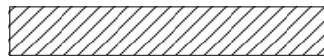

3 B*H 1000*550



4 B*H 1000*350

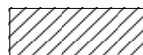

BELASTINGGEVALLEN

B.G.	Omschrijving	Belast/onbelast	Ψ_0	Ψ_1	Ψ_2	e.g.
1	Permanent	2:Permanent EN1991				-1.00
2	Veranderlijk	1:Schaakbord EN1991	0.60	0.70	0.60	0.00
3	Sneeuw	0:Alles tegelijk	0.00	0.20	0.00	0.00

BELASTINGGEVALLEN

B.G.	Omschrijving	Type
1	Permanent	1 Permanente belasting
2	Veranderlijk	2 Ver. bel. pers. ed. (q_k)
3	Sneeuw	22 Sneeuw A

VELDBELASTINGEN

Ligger:basis bedding B.G:1 Permanent

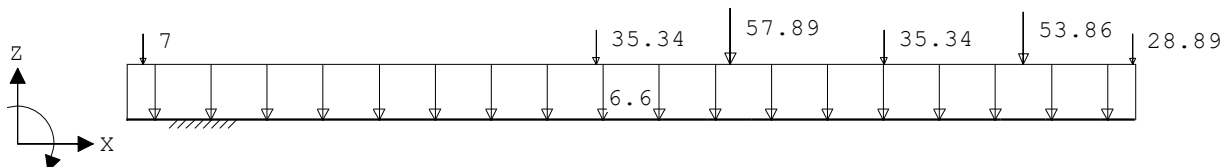

VELDBELASTINGEN

Ligger:basis bedding B.G:1 Permanent

Last Ref.	Type	Omschrijving	q_1 /p/m	q_2 psi	Afstand	Lengte
1	1:q-last		-6.600	-6.600	0.000	18.050
2	8:Puntlast				0.300	
3	8:Puntlast				8.400	
4	8:Puntlast				10.800	
5	8:Puntlast				13.550	
6	8:Puntlast				16.050	
7	8:Puntlast				18.000	

VELDBELASTINGEN

Ligger:basis bedding B.G:2 Veranderlijk

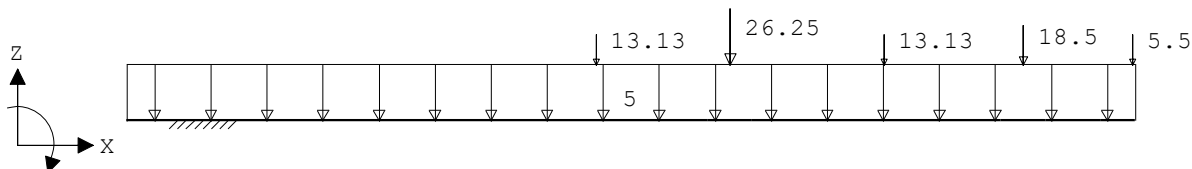

VELDBELASTINGEN

Ligger:basis bedding B.G:2 Veranderlijk

Last Ref.	Type	Omschrijving	q_1 /p/m	q_2 psi	Afstand	Lengte
1	1:q-last		-5.000	-5.000	0.000	18.050
2	8:Puntlast				8.400	
3	8:Puntlast				10.800	
4	8:Puntlast				13.550	
5	8:Puntlast				16.050	
6	8:Puntlast				18.000	

VELDBELASTINGEN

Ligger:basis bedding B.G:3 Sneeuw

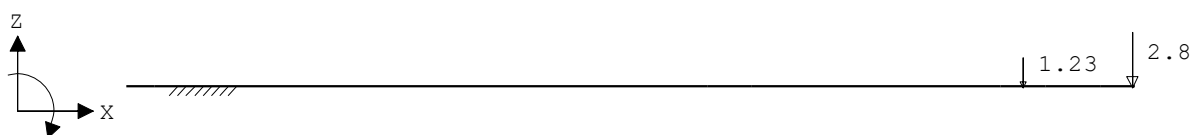

VELDBELASTINGEN

Ligger:basis bedding B.G:3 Sneeuw

Last Ref.	Type	Omschrijving	q1/p/m	q2 psi	Afstand	Lengte
1	8:Puntlast		-1.230		16.050	
2	8:Puntlast		-2.800		18.000	

BELASTINGCOMBINATIES

BC Type	BG	Gen. Factor	BG	Gen. Factor	BG	Gen. Factor	BG	Gen. Factor
1 Fund.	1 Perm	1.35						
2 Fund.	1 Perm	1.35	2 psi0	1.50				
3 Fund.	1 Perm	1.20	2 Extr	1.50				
4 Fund.	1 Perm	1.20	3 Extr	1.50				
5 Fund.	1 Perm	1.20	3 Extr	1.50	2 psi0	1.50		
6 Fund.	1 Perm	0.90						
7 Fund.	1 Perm	0.90	2 psi0	1.50				
8 Fund.	1 Perm	0.90	2 Extr	1.50				
9 Fund.	1 Perm	0.90	3 Extr	1.50				
10 Fund.	1 Perm	0.90	3 Extr	1.50	2 psi0	1.50		
11 Kar.	1 Perm	1.00	2 Extr	1.00				
12 Kar.	1 Perm	1.00	3 Extr	1.00				
13 Kar.	1 Perm	1.00	3 Extr	1.00	2 psi0	1.00		
14 Freq.	1 Perm	1.00						
15 Freq.	1 Perm	1.00	2 psi1	1.00				
16 Freq.	1 Perm	1.00	3 psi1	1.00				
17 Freq.	1 Perm	1.00	3 psi1	1.00	2 psi2	1.00		
18 Quas.	1 Perm	1.00						
19 Quas.	1 Perm	1.00	2 psi2	1.00				
20 Blij.	1 Perm	1.00						

GUNSTIGE WERKING PERMANENTE BELASTINGEN

BC Velden met gunstige werking

- 1 Geen
- 2 Geen
- 3 Geen
- 4 Geen
- 5 Geen
- 6 Alle velden de factor:0.90
- 7 Alle velden de factor:0.90
- 8 Alle velden de factor:0.90
- 9 Alle velden de factor:0.90
- 10 Alle velden de factor:0.90

OMHULLENDE VAN DE FUNDAMENTELE COMBINATIES**MOMENTEN** Fysisch lineair

Ligger:basis bedding Fundamentele combinatie

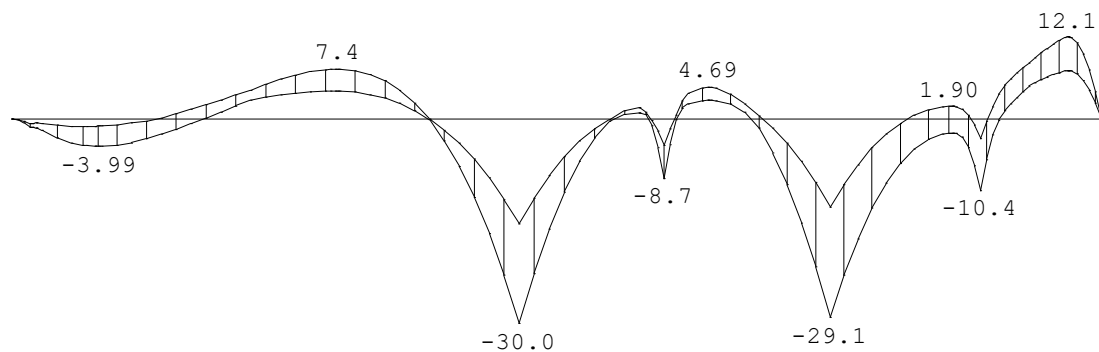

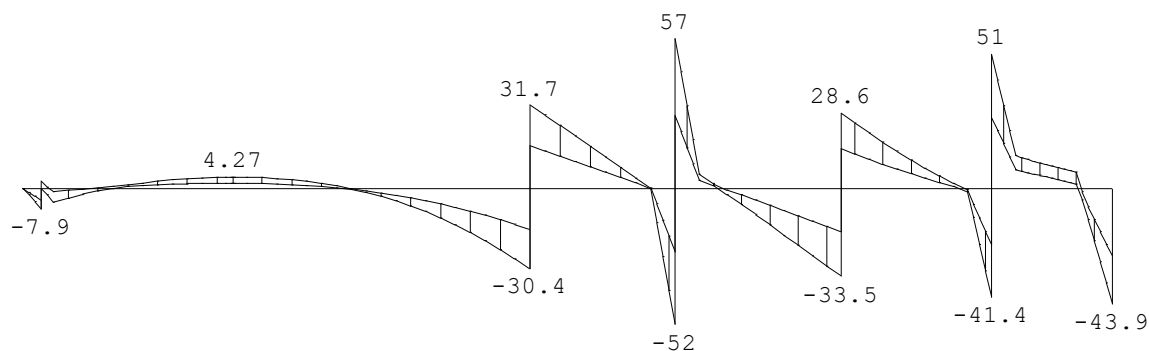

VELDWAARDEN Fysisch lineair

Ligger:basis bedding Fundamentele combinatie

Veld	Pos.	Grondspan. [kN/m ²]		Dwarskr		Moment	
		min.	max.	min.	max.	min.	max.
1	0.000	32.68	56.74	0.00	0.00	0.00	0.00
1	0.300			-7.89	-4.49	-1.16	-0.66
1	0.300			-0.09	2.72	-1.16	-0.66
1	0.318					-1.15	
1	0.415						-0.56
1	0.420				0.00		
1	0.500	34.67	62.37	-5.34	-1.38	-1.63	-0.62
1	0.500	34.67	62.37	-5.34	-1.38	-1.63	-0.62
1	1.156				0.00		
1	1.174						-1.06
1	1.457					-3.99	
1	1.498			0.00			
1	2.375						0.00
1	3.161					0.00	
1	3.357			1.90			
1	3.484				4.27		
1	5.253			0.00			
1	5.282					4.18	
1	5.405						7.37
1	5.429				0.00		
1	6.902					0.00	
1	6.926						0.00
1	8.400			-30.44	-15.59	-30.03	-15.41
1	8.400			16.20	31.66	-30.03	-15.41
1	9.900	18.55					
1	9.911						0.00
1	9.969					0.00	
1	10.150	18.55					
1	10.374			0.00			
1	10.400	79.52	160.92	-0.24	0.16	0.97	1.69
1	10.400	79.52	160.92	-0.24	0.16	0.97	1.69
1	10.403				0.00		
1	10.541					0.00	
1	10.584						0.00
1	10.800			-51.84	-24.36	-8.76	-3.87
1	10.800			27.60	57.00	-8.76	-3.87
1	10.969						0.00
1	11.005					0.00	
1	11.200	79.62	161.21	2.98	5.31	2.24	3.79

VELDWAARDEN Fysisch lineair

Ligger:basis bedding Fundamentele combinatie

Veld	Pos.	Grondspan. [kN/m2]		Dwarskr		Moment	
		min.	max.	min.	max.	min.	max.
1	11.200	79.62	161.21	2.98	5.31	2.24	3.79
1	11.508			0.00			
1	11.541						4.69
1	11.563					2.79	
1	11.609				0.00		
1	12.244					0.00	
1	12.439						0.00
1	13.080		38.19				
1	13.315	19.00					
1	13.550			-33.51	-16.41	-29.14	-12.94
1	13.550			14.98	28.59	-29.14	-12.94
1	14.836						0.00
1	15.501			0.00			
1	15.544						1.90
1	15.612					-2.05	
1	15.617				0.00		
1	15.650	71.34	137.11	-1.20	-0.32	-2.06	1.85
1	15.650	71.34	137.11	-1.20	-0.32	-2.06	1.85
1	15.890						0.00
1	16.050			-41.47	-21.56	-10.49	-2.81
1	16.050			26.91	50.91	-10.49	-2.81
1	16.163						0.00
1	16.358					0.00	
1	16.450	66.85	125.14	7.05	12.42	1.28	5.03
1	16.450	66.85	125.14	7.05	12.42	1.28	5.03
1	17.450	62.22	111.43	1.67	6.30	7.11	11.97
1	17.450	62.22	111.43	1.67	6.30	7.11	11.97
1	17.477			0.00			
1	17.501					7.18	12.08
1	17.532				0.00		
1	18.000			-39.95	-23.67		
1	18.050	60.34	104.95	-43.95	-26.00	0.00	0.00

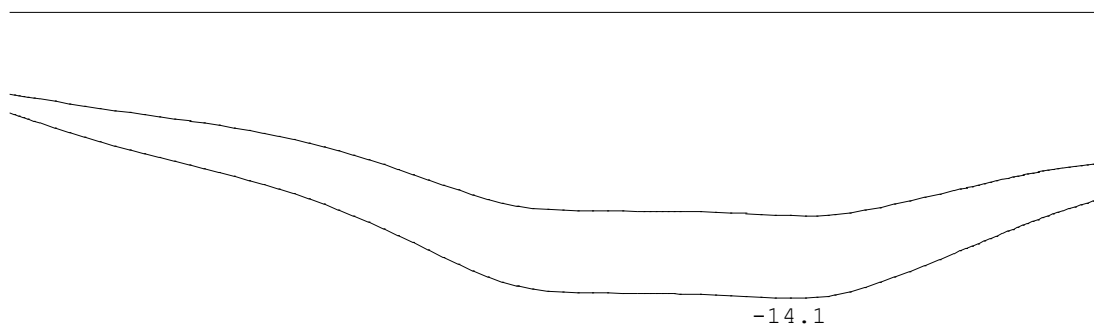
OMHULLENDE VAN DE KARAKTERISTIEKE COMBINATIES**VERPLAATSINGEN** [mm] Fys.NLE.kort Ligger:basis bedding Karakteristieke combinatie

N.B. In deze verplaatsingen is de kruipvervorming (w2) niet verwerkt!

PROFIELGEGEVENS Vloer [N] [mm] t.b.v. profiel:1 B*H 1000*200**Algemeen**

Materiaal : C20/25

Doorsnedebreedte : 1000 hoogte : 200 zwaartepunt tov onderkant : 100
Fictieve dikte : 200.0Betonkwaliteit element : C20/25 Kruipcoëf. : 3.010
Staalkwaliteit hoofdwapening : 500 ϵ_{uk} : 2.50
Staalkwaliteit beugels : 500**Betondekking**

	Boven	Onder
Milieu	XC1	XC3
Hoofdwapening	1ste laag	1ste laag
Nominale dekking	15	30
Toegepaste dekking	25	30
Beugel / Verdeelwapening	2de laag	2de laag
Nominale dekking	15	30
Toegepaste dekking	33	38

Wapening

	Boven	Onder
Basiswapening	8-100	8-100
Hoofdwapening laag	1	1
Diameter verdeelwapening	8.0	8.0

DwarskrachtwapeningMin. hoek betondrukdiagonaal θ : 21.8 z berekenen via: MRd**PROFIELGEGEVENS Vloer [N] [mm]** t.b.v. profiel:2 B*H 2000*300**Algemeen**

Materiaal : C20/25

Doorsnedebreedte : 2000 hoogte : 300 zwaartepunt tov onderkant : 150
Fictieve dikte : 300.0Betonkwaliteit element : C20/25 Kruipcoëf. : 3.010
Staalkwaliteit hoofdwapening : 500 ϵ_{uk} : 2.50
Staalkwaliteit beugels : 500**Betondekking**

	Boven	Onder
Milieu	XC1	XC3
Hoofdwapening	1ste laag	1ste laag
Nominale dekking	15	30
Toegepaste dekking	25	30
Beugel / Verdeelwapening	2de laag	2de laag
Nominale dekking	15	30
Toegepaste dekking	33	40

Wapening

	Boven	Onder
Basiswapening	8-150	10-100
Hoofdwapening laag	1	1
Diameter verdeelwapening	10.0	10.0

DwarskrachtwapeningMin. hoek betondrukdiagonaal θ : 21.8 z berekenen via: MRd**PROFIELGEGEVENS Vloer [N] [mm]** t.b.v. profiel:3 B*H 1000*550**Algemeen**

Materiaal : C20/25

Doorsnede

breedte : 1000 hoogte : 550 zwaartepunt tov onderkant : 275
 Fictieve dikte : 550.0

Betonkwaliteit element : C20/25 Kruipcoëf. : 3.010
 Staalkwaliteit hoofdwapening : 500 ϵ_{uk} : 2.50
 Staalkwaliteit beugels : 500

Betondekking

	Boven	Onder
Milieu	XC1	XC3
Hoofdwapening	1ste laag	1ste laag
Nominale dekking	15	30
Toegepaste dekking	25	30
Beugel / Verdeelwapening	2de laag	2de laag
Nominale dekking	15	30
Toegepaste dekking	33	40

Wapening

	Boven	Onder
Basiswapening	8-100	10-150
Hoofdwapening laag	1	1
Diameter verdeelwapening	8.0	10.0

Dwarskrachtwapening

Min. hoek betondrukdiagonaal θ : 21.8 z berekenen via: MRd

PROFIELGEGEVENS Vloer**[N] [mm]**

t.b.v. profiel:4 B*H 1000*350

Algemeen

Materiaal : C20/25

Doorsnede

breedte : 1000 hoogte : 350 zwaartepunt tov onderkant : 175
 Fictieve dikte : 350.0

Betonkwaliteit element : C20/25 Kruipcoëf. : 3.010
 Staalkwaliteit hoofdwapening : 500 ϵ_{uk} : 2.50
 Staalkwaliteit beugels : 500

Betondekking

	Boven	Onder
Milieu	XC1	XC3
Hoofdwapening	1ste laag	1ste laag
Nominale dekking	15	30
Toegepaste dekking	25	30
Beugel / Verdeelwapening	2de laag	2de laag
Nominale dekking	15	30
Toegepaste dekking	33	40

Wapening

	Boven	Onder
Basiswapening	8-100	10-150
Hoofdwapening laag	1	1
Diameter verdeelwapening	8.0	10.0

Dwarskrachtwapening

Min. hoek betondrukdiagonaal θ : 21.8 z berekenen via: MRd

Hoofdwapening Fysisch lineair

Ligger:basis bedding Fundamentele combinatie

8-100 a

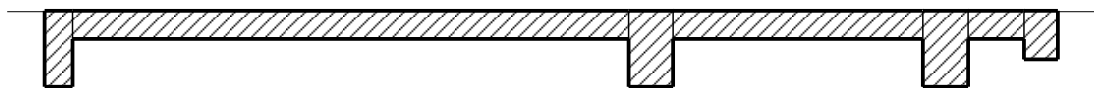

10-150 b

10-150 d

10-150 f 10-150 h

8-100 c

8-100 e

8-100 g

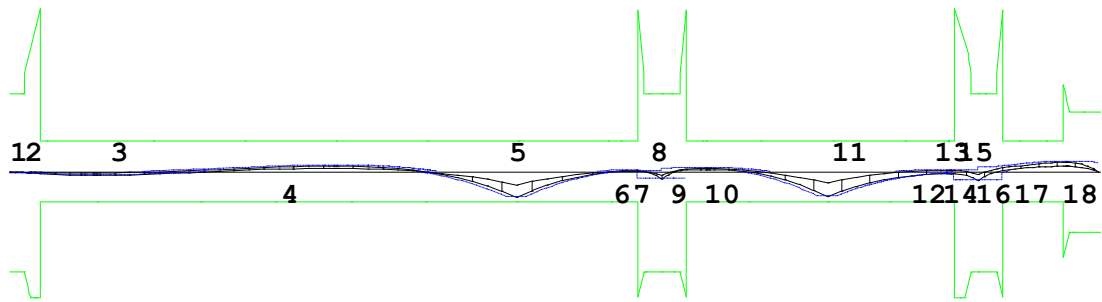

Hoofdwapening

Ligger:basis bedding

Geb.	Pos. [mm]	M _{E,d} [kNm]	M _{R,d} [kNm]	z [mm]	B/O	A _b [mm ²]	A _a [mm ²]	Basiswapening +Bijlegwapening	Opm.
1	300	-1.63	-140.34	366	Ond	402*	524	10-150	54
2	500	-3.52	-150.70	328	Ond	402*	524	10-150	54
3	1457	-3.99	-36.13	131	Ond	177*	503	8-100	54
4	5405	7.37	37.72	124	Bov	177*	503	8-100	54
5	8400	-30.03	-36.13	131	Ond	418	503	8-100	
6	10400	1.69	37.72	124	Bov	177*	503	8-100	54
7	10400	1.69	196.82	434	Bov	402*	503	8-100	54
8	10800	-8.76	-119.62	503	Ond	402*	524	10-150	54
9	11200	4.62	196.82	434	Bov	402*	503	8-100	54
10	11541	4.69	37.72	124	Bov	177*	503	8-100	54
11	13550	-29.14	-36.13	131	Ond	405	503	8-100	
12	15544	1.90	37.72	124	Bov	177*	503	8-100	54
13	15650	-3.64	-36.13	131	Ond	177*	503	8-100	54
14	15650	1.87	196.89	434	Bov	402*	503	8-100	54
15	16050	-10.49	-119.62	503	Ond	402*	524	10-150	54
16	16450	9.18	196.82	434	Bov	402*	503	8-100	54
17	17450	12.03	37.72	124	Bov	199*	503	8-100	1
18	17501	12.08	88.88	258	Bov	299*	503	8-100	54

Opmerkingen

- [1] * = Eisen met betrekking tot minimum wapening zijn toegepast, zie nationale bijlage art. 9.2.1.1(1).
- [54] * = Eisen met betrekking tot minimum wapening ten behoeve van gecontroleerde scheurvorming zijn toegepast volgens art. 7.3.2.
- [93] De wapening bij de doorsnede overgang is niet getoetst vlg. NEN-EN 1992-1-1 art.9.9.

Scheurvorming volgens artikel 7.3.4

Ligger:basis bedding

Geb.	Pos. [mm]	Zijde	M _{E, freq} [kNm]	S _{r, max} [mm]	ε _{s,m} -ε _{c,m} [%]	w _k [mm]	k _x	w _{max} [mm]	U.C.	Opm.
1	5405	Bov	5.48	237	0.203	0.048	1.67	0.667	0.07	
1	10400	Bov	1.26	237	0.047	0.011	1.67	0.667	0.02	
1	10800	Bov	2.83	272	0.034	0.009	1.67	0.667	0.01	
1	11541	Bov	3.49	237	0.129	0.031	1.67	0.667	0.05	
1	0	Ond	-1.06	340	0.012	0.004	1.00	0.300	0.01	
1	234	Ond	-1.06	340	0.012	0.004	1.00	0.300	0.01	
1	1457	Ond	-2.35	255	0.090	0.023	1.00	0.300	0.08	
1	8400	Ond	-21.55	255	0.848	0.216	1.00	0.300	0.72	

Schuifspanningen

Ligger:basis bedding

Geb.	Vanaf [mm]	Tot [mm]	θ [°]	V_{Ed} [kN]	$V_{Ed} < V_{Rd} < V_{Rd, max}$ -----[N/mm ²]-----	V_{opg} [N/mm ²]	Opm.	
1	0	500	21.8	8	0.02	0.28	1.62	71
2	500	7100	21.8	13	0.08	0.56	2.01	71
3	7100	9800	21.8	32	0.19	0.50	2.01	71
4	9800	10400	21.8	9	0.06	0.57	2.01	71
5	10400	10950	21.8	57	0.11	0.28	2.48	71
6	10950	11200	21.8	37	0.08	0.30	2.44	71
7	11200	12375	21.8	14	0.08	0.55	1.85	71
8	12375	15650	21.8	34	0.20	0.50	2.01	71
9	15650	16200	21.8	51	0.10	0.28	2.48	71
10	16200	16450	21.8	36	0.08	0.30	2.44	71
11	16450	17450	21.8	12	0.07	0.49	1.85	71
12	17450	18050	21.8	44	0.14	0.36	2.07	71

Opmerkingen

[71] Er wordt voor platen geen minimale dwarskrachtwapening volgens art. 9.3.2 toegepast. Uitgangspunt hiervoor is dat er herverdeling van belastingen in dwarsrichting mogelijk is (zie art. 6.2.1(4)).

LIGGER:lage bedding poer

GEOMETRIE

Ligger:lage bedding poer

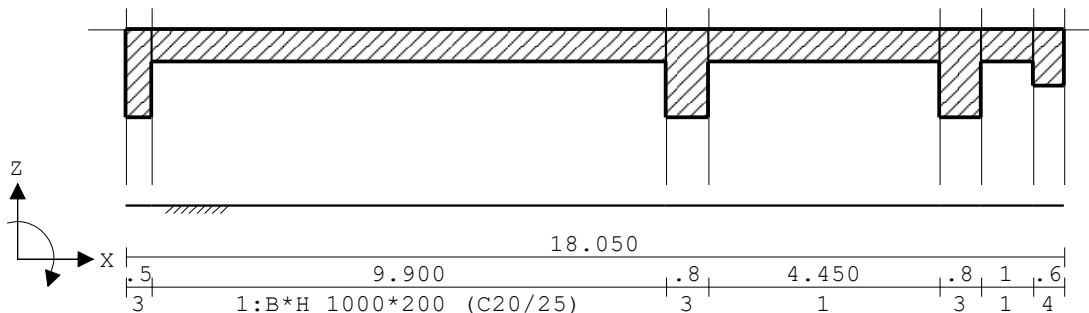

VELDLENGTEN

Ligger:lage bedding poer

Veld	Vanaf	Tot	Lengte
1	0.000	18.050	18.050

DOORSNEDEN

Ligger:lage bedding poer

sector	Vanaf	Tot	Lengte	Profiel begin	z-begin	Profiel eind	z-eind
1	0.000	0.500	0.500	3:B*H 1000*550	0.000	3:B*H 1000*550	0.000
2	0.500	10.400	9.900	1:B*H 1000*200	0.000	1:B*H 1000*200	0.000
3	10.400	11.200	0.800	3:B*H 1000*550	0.000	3:B*H 1000*550	0.000
4	11.200	15.650	4.450	1:B*H 1000*200	0.000	1:B*H 1000*200	0.000
5	15.650	16.450	0.800	3:B*H 1000*550	0.000	3:B*H 1000*550	0.000
6	16.450	17.450	1.000	1:B*H 1000*200	0.000	1:B*H 1000*200	0.000
7	17.450	18.050	0.600	4:B*H 1000*350	0.000	4:B*H 1000*350	0.000

sector	Vanaf	Tot	Lengte	Eindcode	Bedding	Br. [mm]
1	0.000	0.500	0.500	1:Vast	6900	1000
2	0.500	10.400	9.900	1:Vast	2750	1000
3	10.400	11.200	0.800	1:Vast	6900	1000
4	11.200	15.650	4.450	1:Vast	2750	1000
5	15.650	16.450	0.800	1:Vast	6900	1000
6	16.450	17.450	1.000	1:Vast	2750	1000
7	17.450	18.050	0.600	1:Vast	6900	1000

PROFIELVORMEN [mm]

1 B*H 1000*200

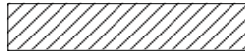

2 B*H 2000*300

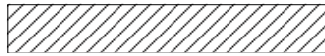

3 B*H 1000*550



4 B*H 1000*350

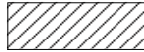

VELDBELASTINGEN

Ligger:lage bedding poer B.G:1 Permanent

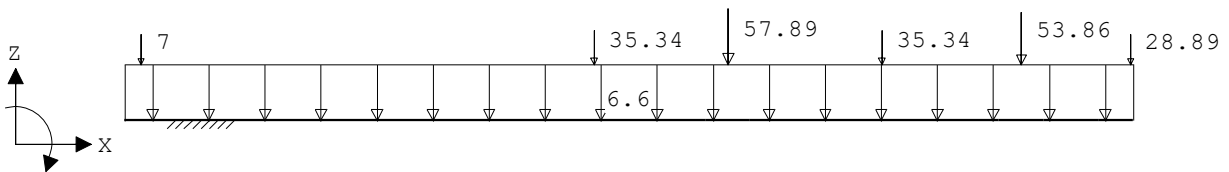

VELDBELASTINGEN

Ligger:lage bedding poer B.G:1 Permanent

Last Ref.	Type	Omschrijving	q1/p/m	q2 psi	Afstand	Lengte
1	1:q-last		-6.600	-6.600	0.000	18.050
2	8:Puntlast				0.300	
3	8:Puntlast				8.400	
4	8:Puntlast				10.800	
5	8:Puntlast				13.550	
6	8:Puntlast				16.050	
7	8:Puntlast				18.000	

VELDBELASTINGEN

Ligger:lage bedding poer B.G:2 Veranderlijk

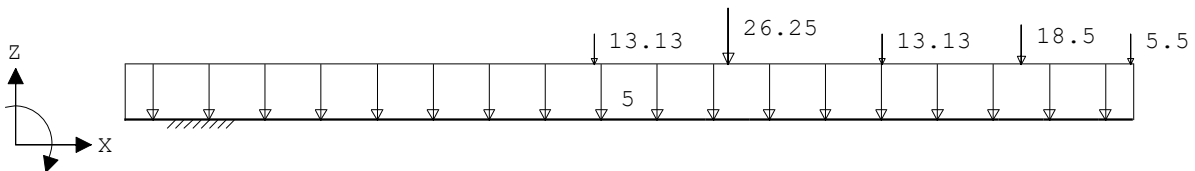

VELDBELASTINGEN

Ligger:lage bedding poer B.G:2 Veranderlijk

Last Ref.	Type	Omschrijving	q1/p/m	q2 psi	Afstand	Lengte
1	1:q-last		-5.000	-5.000	0.000	18.050
2	8:Puntlast				8.400	
3	8:Puntlast				10.800	
4	8:Puntlast				13.550	
5	8:Puntlast				16.050	
6	8:Puntlast				18.000	

VELDBELASTINGEN

Ligger:lage bedding poer B.G:3 Sneeuw

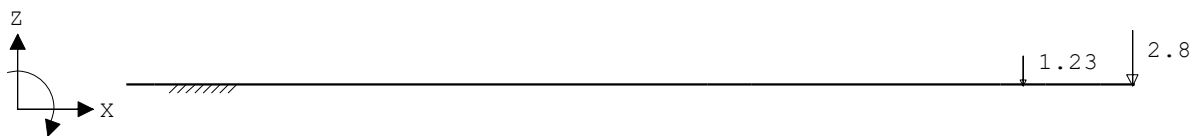

VELDBELASTINGEN

Ligger:lage bedding poer B.G:3 Sneeuw

Last Ref.	Type	Omschrijving	q1/p/m	q2	psi	Afstand	Lengte
1	8:Puntlast		-1.230			16.050	
2	8:Puntlast		-2.800			18.000	

OMHULLENDE VAN DE FUNDAMENTELE COMBINATIES

MOMENTEN Fysisch lineair

Ligger:lage bedding poer Fundamentele combinatie

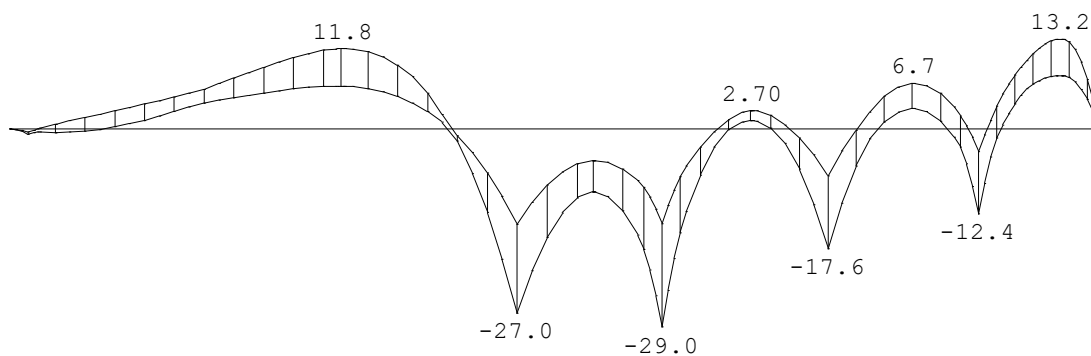

DWARSKRACHTEN Fysisch lineair

Ligger:lage bedding poer Fundamentele combinatie

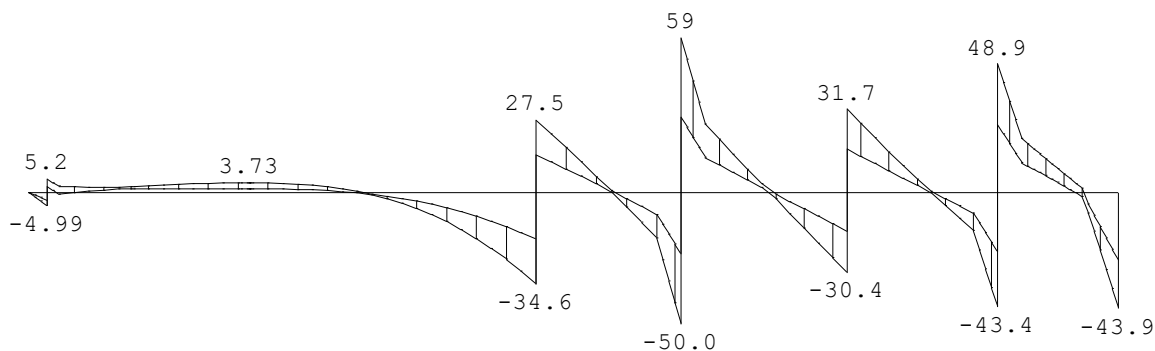

VELDWAARDEN Fysisch lineair

Ligger:lage bedding poer Fundamentele combinatie

Veld	Pos.	Grondspan. [kN/m ²]		Dwarskr		Moment	
		min.	max.	min.	max.	min.	max.
1	0.000	28.04	48.71	0.00	0.00	0.00	0.00
1	0.200		48.67				
1	0.300			-5.01	-2.86	-0.75	-0.43
1	0.300			2.24	5.15	-0.75	-0.43
1	0.457						0.00
1	0.462			0.00			
1	0.500	27.45	48.97	-0.53	2.38	-0.43	0.10
1	0.500	27.45	48.97	-0.53	2.38	-0.43	0.10

VELDWAARDEN Fysisch lineair

Ligger:lage bedding poer Fundamentele combinatie

Veld	Pos.	Grondspan. [kN/m2]		Dwarskr		Moment	
		min.	max.	min.	max.	min.	max.
1	0.765			0.00		-0.50	
1	1.488				1.97		
1	1.509					0.00	
1	2.722	10.27					
1	3.515			1.51			
1	3.653				3.73		
1	5.372			0.00			
1	5.395					6.31	
1	5.536						11.81
1	5.556				0.00		
1	7.255					0.00	
1	7.335						0.00
1	8.400			-34.63	-17.66	-27.03	-13.95
1	8.400			14.14	27.48	-27.03	-13.95
1	9.657			0.00			
1	9.664					-9.24	
1	9.692						-4.59
1	9.708				0.00		
1	10.400	56.05	113.58	-17.33	-8.31	-15.58	-7.54
1	10.400	56.05	113.58	-17.33	-8.31	-15.58	-7.54
1	10.800			-50.07	-23.43	-29.06	-13.91
1	10.800			28.52	58.77	-29.06	-13.91
1	11.200	56.29	114.22	13.26	25.91	-12.11	-5.47
1	11.200	56.29	114.22	13.26	25.91	-12.11	-5.47
1	11.435	22.44	45.55				
1	11.729						0.00
1	11.924					0.00	
1	12.140	22.39					
1	12.244			0.00			
1	12.272					1.25	
1	12.320						2.70
1	12.341				0.00		
1	12.622					0.00	
1	12.916						0.00
1	13.315	22.50					
1	13.550			-30.42	-14.68	-17.59	-6.82
1	13.550			16.62	31.69	-17.59	-6.82
1	14.029						0.00
1	14.385					0.00	
1	14.950					3.01	
1	14.953			0.00			
1	14.982						6.72
1	14.992				0.00		
1	15.417	21.89					
1	15.534					0.00	
1	15.650	54.92	104.98	-14.52	-7.87	-1.15	3.22
1	15.650	54.92	104.98	-14.52	-7.87	-1.15	3.22
1	15.880						0.00
1	16.050			-43.48	-22.57	-12.42	-3.35
1	16.050			25.90	48.90	-12.42	-3.35
1	16.189						0.00
1	16.417					0.00	
1	16.450	54.97	102.36	11.24	20.46	0.64	5.16
1	16.450	54.97	102.36	11.24	20.46	0.64	5.16
1	17.338			0.00			

VELDWAARDEN Fysisch lineair Ligger:lage bedding poer Fundamentele combinatie

Veld	Pos.	Grondspan. [kN/m2]		Dwarskr		Moment	
		min.	max.	min.	max.	min.	max.
1	17.421					7.87	13.21
1	17.450	55.91	100.21	-1.62	1.73	7.86	13.20
1	17.450	55.91	100.21	-1.62	1.73	7.86	13.20
1	17.479				0.00		
1	17.950		100.11				
1	18.000			-40.22	-23.83		
1	18.050	57.28	100.16	-43.95	-26.00	0.00	0.00

OMHULLENDE VAN DE KARAKTERISTIEKE COMBINATIES

VERPLAATSINGEN [mm] Fys.NLE.kortLigger:lagebedding poer Karakteristieke combinatie

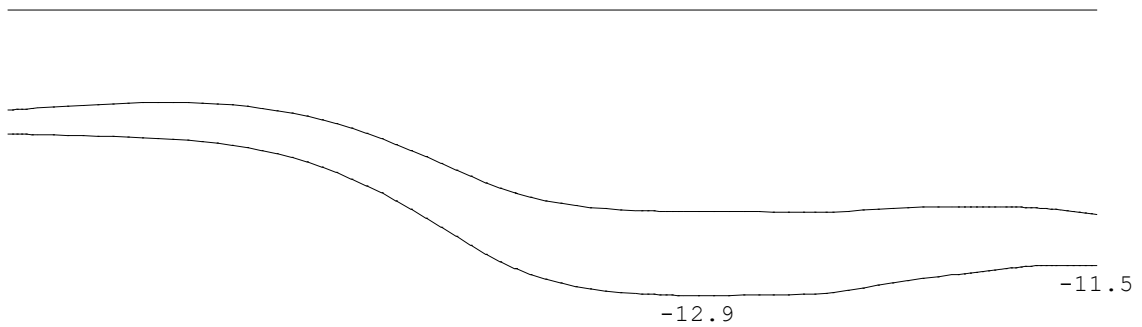

N.B. In deze verplaatsingen is de kruipvervorming (w2) niet verwerkt!

Hoofdwapening Fysisch lineair Ligger:lage bedding poer Fundamentele combinatie

8-100 a

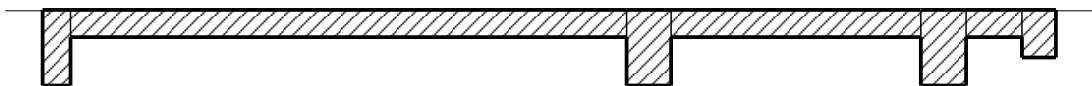

10-150 b
8-100 c

10-150 d
8-100 e

10-150 f 10-150 h
8-100 g

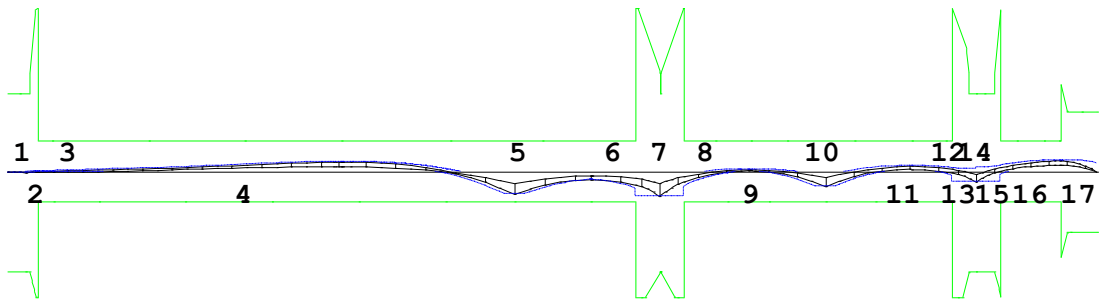

Hoofdwapening

Ligger:lage bedding poer

Geb.	Pos. [mm]	$M_{E,d}$ [kNm]	$M_{R,d}$ [kNm]	z	B/O	A_b [mm ²]	A_a [mm ²]	Basiswapening +Bijlegwapening	Opm.
1	300	-0.75	-119.62	503	Ond	402*	524	10-150	54
2	500	1.26	196.89	434	Bov	402*	503	8-100	54
3	765	-0.50	-36.13	131	Ond	177*	503	8-100	54
4	5536	11.81	37.72	124	Bov	195*	503	8-100	1
5	8400	-27.03	-36.13	131	Ond	374	503	8-100	
6	10400	-19.68	-36.13	131	Ond	284*	503	8-100	1
7	10800	-29.06	-120.78	491	Ond	402*	524	10-150	54
8	11200	-17.64	-36.13	131	Ond	284*	503	8-100	1
9	12320	2.70	37.72	124	Bov	177*	503	8-100	54
10	13550	-17.59	-36.13	131	Ond	284*	503	8-100	1
11	14982	6.72	37.72	124	Bov	177*	503	8-100	54
12	15650	-4.31	-36.13	131	Ond	177*	503	8-100	54
13	15650	6.49	196.89	434	Bov	402*	503	8-100	54
14	16050	-12.42	-119.62	503	Ond	402*	524	10-150	54
15	16450	11.19	196.82	434	Bov	402*	503	8-100	54
16	17421	13.21	37.72	124	Bov	218*	503	8-100	1
17	17450	13.20	106.32	235	Bov	299*	503	8-100	54

Opmerkingen

- [1] * = Eisen met betrekking tot minimum wapening zijn toegepast, zie nationale bijlage art. 9.2.1.1(1).
- [54] * = Eisen met betrekking tot minimum wapening ten behoeve van gecontroleerde scheurvorming zijn toegepast volgens art. 7.3.2.
- [93] De wapening bij de doorsnede overgang is niet getoetst vlg. NEN-EN 1992-1-1 art.9.9.

Scheurvorming volgens artikel 7.3.4

Ligger:lage bedding poer

Geb.	Pos. [mm]	Zijde	$M_{E, freq}$ [kNm]	$S_{r, max}$ [mm]	$\epsilon_{sm} - \epsilon_{cm}$ [%]	w_k [mm]	k_x	w_{max} [mm]	U.C.	Opm.
1	5536	Bov	8.58	237	0.318	0.075	1.67	0.667	0.11	
1	12320	Bov	1.93	237	0.071	0.017	1.67	0.667	0.03	
1	14982	Bov	4.41	237	0.163	0.039	1.67	0.667	0.06	
1	16050	Bov	2.91	272	0.035	0.009	1.67	0.667	0.01	
1	0	Ond	-0.56	340	0.006	0.002	1.00	0.300	0.01	
1	362	Ond	-0.56	340	0.006	0.002	1.00	0.300	0.01	
1	462	Ond	-0.56	300	0.006	0.002	1.00	0.300	0.01	
1	500	Ond	-0.21	255	0.008	0.002	1.00	0.300	0.01	

Schuifspanningen

Ligger:lage bedding poer

Geb.	Vanaf [mm]	Tot [mm]	θ [°]	V_{Ed} [kN]	$V_{Ed} <$	$V_{Rd} <$	$V_{Rd, max}$	V_{opg} [N/mm ²]	Opm.
					-----	[N/mm ²]	-----	[N/mm ²]	
1	0	500	21.8	5	0.01	0.28	2.29	71	
2	500	7400	21.8	17	0.10	0.55	1.85	71	
3	7400	10400	21.8	35	0.21	0.50	2.01	71	
4	10400	11200	21.8	59	0.11	0.28	1.84	71	
5	11200	12975	21.8	26	0.16	0.50	2.01	71	
6	12975	14175	21.8	32	0.19	0.50	2.01	71	
7	14175	15650	21.8	17	0.10	0.51	1.85	71	
8	15650	16450	21.8	49	0.09	0.28	2.48	71	
9	16450	17450	21.8	20	0.12	0.49	1.85	71	
10	17450	18050	21.8	44	0.14	0.36	2.07	71	

Opmerkingen

[71] Er wordt voor platen geen minimale dwarskrachtwapening volgens art. 9.3.2 toegepast. Uitgangspunt hiervoor is dat er herverdeling van belastingen in dwarsrichting mogelijk is (zie art. 6.2.1(4)).

5.2.3 Doorsnede as 2

Technosoft Liggers release 6.83a

18 dec 2025

Project.....: 10745
 Onderdeel....: Doorsnede as 2
 Dimensies....: kN/m/rad
 Bestand.....: N:\Order\10000\10700\10745\berekeningen en schetsen\bgg
 dsn as 2.dlw

Betrouwbaarheidsklasse : 2 Referentieperiode : 50
 Herverdelen van momenten : nee Maximale deellengte : 0.500
 Ouderdom bij belasten : 28 Relatieve vochtigheid : 50%
 Doorbuigingen(beton) zijn dmv gecorrigeerde stijfheden berekend.

Fysisch lineair : Er is gerekend met de e-modulus uit de materiaaltabel.
 Fys.NLE.kort : Er is gerekend met een gecorrigeerde e-modulus (korte duur).
 Deze e-mod. is berekend mbv de krachten uit de fysisch lineair berekening.

Toegepaste normen volgens Eurocode met Nederlandse NB

Belastingen	NEN-EN 1990:2002	C2:2010,A1:2019	NB:2019 (nl)
	NEN-EN 1991-1-1:2002	C1/C11:2019	NB:2019 (nl)
Beton	NEN-EN 1992-1-1:2011 (nl)	C2/A1:2020 (nl)	NB:2016 (nl)



LIGGER:basis bedding

GEOMETRIE

Ligger:basis bedding

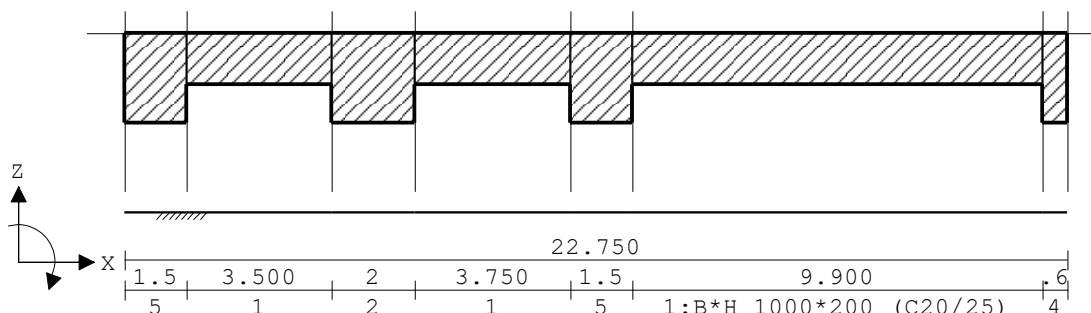

VELDLENGTEN

Ligger:basis bedding

Veld	Vanaf	Tot	Lengte
1	0.000	22.750	22.750

MATERIALEN

Mt	Kwaliteit	E-modulus[N/mm ²]	S.G.	Pois.	Uitz. coëff
1	C20/25	29962	25.0	0.20	1.0000e-05

MATERIALEN vervolg

Mt	Kwaliteit	Cement	Kruipfac.
1	C20/25	N	3.01

PROFIELEN [mm]

Prof.	Omschrijving	Materiaal	Oppervlak	Traagheid	Vormf.
1	B*H 1000*200	1:C20/25	2.0000e+05	6.6667e+08	0.00
2	B*H 2000*350	1:C20/25	7.0000e+05	7.1458e+09	0.00
3	B*H 1000*550	1:C20/25	5.5000e+05	1.3865e+10	0.00
4	B*H 1000*350	1:C20/25	3.5000e+05	3.5729e+09	0.00
5	B*H 1500*350	1:C20/25	5.2500e+05	5.3594e+09	0.00

PROFIELEN vervolg [mm]

Prof.	Staaftype	Breedte	Hoogte	e	Type	b1	h1	b2	h2
1	0:Normaal	1000	200	100.0	0:RH				
2	0:Normaal	2000	350	175.0	0:RH				
3	0:Normaal	1000	550	275.0	0:RH				
4	0:Normaal	1000	350	175.0	0:RH				
5	0:Normaal	1500	350	175.0	0:RH				

DOORSNEDEN

Ligger:basis bedding

sector	Vanaf	Tot	Lengte	Profiel begin	z-begin	Profiel eind	z-eind
1	0.000	1.500	1.500	5:B*H 1500*350	0.000	5:B*H 1500*350	0.000
2	1.500	5.000	3.500	1:B*H 1000*200	0.000	1:B*H 1000*200	0.000
3	5.000	7.000	2.000	2:B*H 2000*350	0.000	2:B*H 2000*350	0.000
4	7.000	10.750	3.750	1:B*H 1000*200	0.000	1:B*H 1000*200	0.000
5	10.750	12.250	1.500	5:B*H 1500*350	0.000	5:B*H 1500*350	0.000
6	12.250	22.150	9.900	1:B*H 1000*200	0.000	1:B*H 1000*200	0.000
7	22.150	22.750	0.600	4:B*H 1000*350	0.000	4:B*H 1000*350	0.000

sector	Vanaf	Tot	Lengte	Eindcode	Bedding	Br. [mm]
1	0.000	1.500	1.500	1:Vast	9000	1500
2	1.500	5.000	3.500	1:Vast	2100	1000
3	5.000	7.000	2.000	1:Vast	9000	2000
4	7.000	10.750	3.750	1:Vast	2100	1000
5	10.750	12.250	1.500	1:Vast	9000	1500
6	12.250	22.150	9.900	1:Vast	2100	1000
7	22.150	22.750	0.600	1:Vast	9000	1000

PROFIELVORMEN [mm]

1 B*H 1000*200

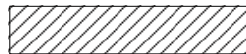

2 B*H 2000*350

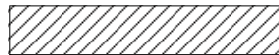

3 B*H 1000*550



4 B*H 1000*350

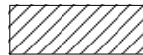

5 B*H 1500*350

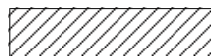

BELASTINGGEVALLEN

B.G.	Omschrijving	Belast/onbelast	Ψ_0	Ψ_1	Ψ_2	e.g.
1	Permanent	2:Permanent EN1991				-1.00
2	Veranderlijk	1:Schaakbord EN1991	0.60	0.70	0.60	0.00
3	Sneeuw	0:Alles tegelijk	0.00	0.20	0.00	0.00

BELASTINGGEVALLEN

B.G.	Omschrijving	Type
1	Permanent	1 Permanente belasting
2	Veranderlijk	2 Ver. bel. pers. ed. (q_k)
3	Sneeuw	22 Sneeuw A

VELDBELASTINGEN

Ligger:basis bedding B.G:1 Permanent

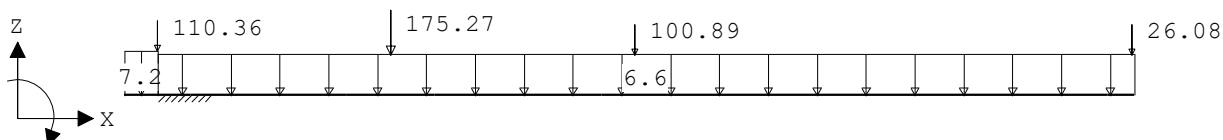

VELDBELASTINGEN

Ligger:basis bedding B.G:1 Permanent

Last Ref.	Type	Omschrijving	$q_1/p/m$	q_2	psi	Afstand	Lengte
1	1:q-last		-7.200	-7.200	0.000	0.750	
2	1:q-last		-6.600	-6.600	0.750	22.000	
3	8:Puntlast		-110.360		0.750		
4	8:Puntlast		-175.270		6.000		
5	8:Puntlast		-100.890		11.500		
6	8:Puntlast		-26.080		22.700		

VELDBELASTINGEN

Ligger:basis bedding B.G:2 Veranderlijk

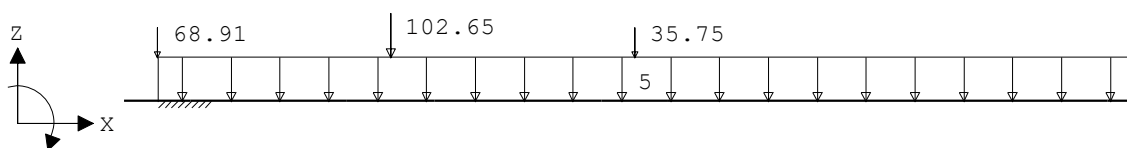

VELDBELASTINGEN

Ligger:basis bedding B.G:2 Veranderlijk

Last Ref.	Type	Omschrijving	$q_1/p/m$	q_2	psi	Afstand	Lengte
1	1:q-last		-5.000	-5.000	0.750	22.000	
2	8:Puntlast		-68.910		0.750		
3	8:Puntlast		-102.650		6.000		
4	8:Puntlast		-35.750		11.500		

VELDBELASTINGEN

Ligger:basis bedding B.G:3 Sneeuw

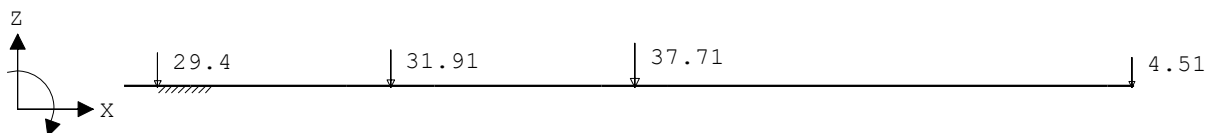

VELDBELASTINGEN

Ligger:basis bedding B.G:3 Sneeuw

Last Ref.	Type	Omschrijving	q1/p/m	q2 psi	Afstand	Lengte
1	8:Puntlast		-29.400		0.750	
2	8:Puntlast		-31.910		6.000	
3	8:Puntlast		-37.710		11.500	
4	8:Puntlast		-4.510		22.700	

BELASTINGCOMBINATIES

BC	Type	BG	Gen. Factor	BG	Gen. Factor	BG	Gen. Factor	BG	Gen. Factor
1	Fund.	1	Perm	1.35					
2	Fund.	1	Perm	1.35	2	psi0	1.50		
3	Fund.	1	Perm	1.20	2	Extr	1.50		
4	Fund.	1	Perm	1.20	3	Extr	1.50		
5	Fund.	1	Perm	1.20	3	Extr	1.50	2	psi0
6	Fund.	1	Perm	0.90					
7	Fund.	1	Perm	0.90	2	psi0	1.50		
8	Fund.	1	Perm	0.90	2	Extr	1.50		
9	Fund.	1	Perm	0.90	3	Extr	1.50		
10	Fund.	1	Perm	0.90	3	Extr	1.50	2	psi0
11	Kar.	1	Perm	1.00	2	Extr	1.00		
12	Kar.	1	Perm	1.00	3	Extr	1.00		
13	Kar.	1	Perm	1.00	3	Extr	1.00	2	psi0
14	Freq.	1	Perm	1.00					
15	Freq.	1	Perm	1.00	2	psi1	1.00		
16	Freq.	1	Perm	1.00	3	psi1	1.00		
17	Freq.	1	Perm	1.00	3	psi1	1.00	2	psi2
18	Quas.	1	Perm	1.00					
19	Quas.	1	Perm	1.00	2	psi2	1.00		
20	Blij.	1	Perm	1.00					

GUNSTIGE WERKING PERMANENTE BELASTINGEN

BC	Velden met gunstige werking
1	Geen
2	Geen
3	Geen
4	Geen
5	Geen
6	Alle velden de factor:0.90
7	Alle velden de factor:0.90
8	Alle velden de factor:0.90
9	Alle velden de factor:0.90
10	Alle velden de factor:0.90

OMHULLENDE VAN DE FUNDAMENTELE COMBINATIES

MOMENTEN Fysisch lineair

Ligger:basis bedding Fundamentele combinatie

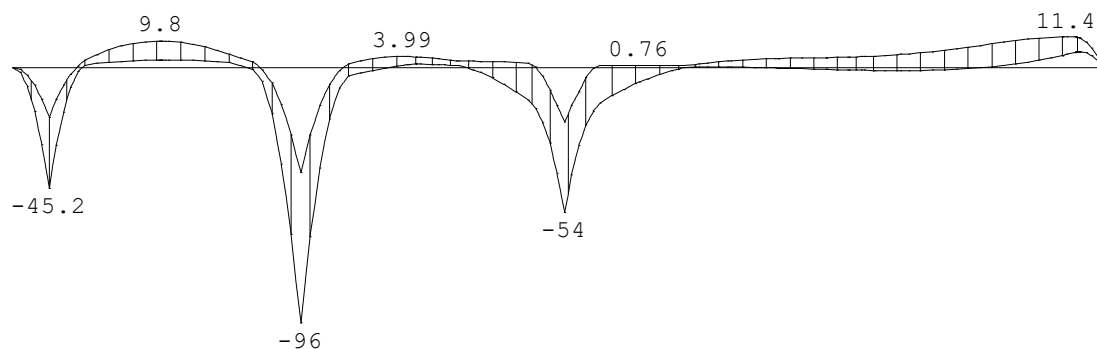

DWARSKRACHTEN Fysisch lineair

Ligger:basis bedding Fundamentele combinatie

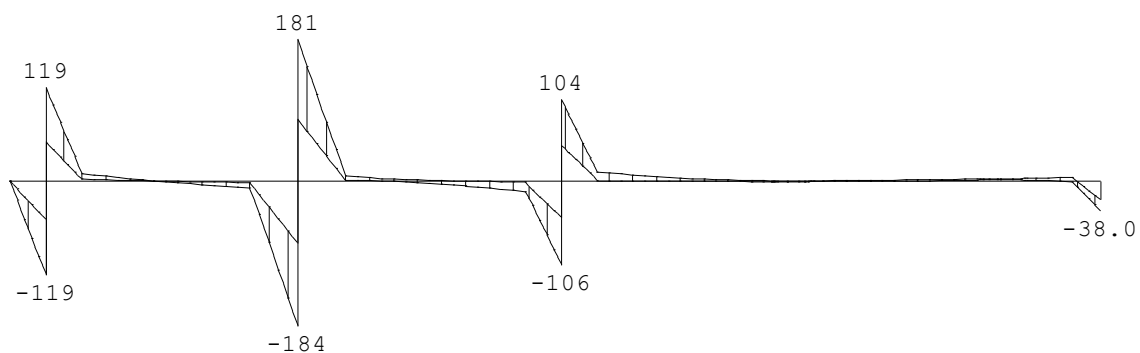

VELDWAARDEN Fysisch lineair

Ligger:basis bedding Fundamentele combinatie

Veld	Pos.	Grondspan. [kN/m ²]		Dwarskr		Moment	
		min.	max.	min.	max.	min.	max.
1	0.000	56.91	125.64	0.00	0.00	0.00	0.00
1	0.750			-119.53	-49.32	-45.27	-18.62
1	0.750			50.01	119.02	-45.27	-18.62
1	1.331						0.00
1	1.451					0.00	
1	1.500	53.06	115.73	2.45	9.86	0.78	2.64
1	1.500	53.06	115.73	2.45	9.86	0.78	2.64
1	3.036			0.00			
1	3.082						9.77
1	3.160					2.75	
1	3.201				0.00		
1	4.250	11.42	24.81				
1	4.868					0.00	
1	5.000	49.20	106.56	-9.05	-1.87	-0.76	2.05
1	5.000	49.20	106.56	-9.05	-1.87	-0.76	2.05
1	5.139						0.00
1	5.600		106.80				
1	6.000	49.67		-183.80	-79.13	-95.68	-39.40
1	6.000	49.67		78.61	180.50	-95.68	-39.40
1	6.898						0.00
1	7.000	49.32	104.71	1.23	6.77	-3.26	1.40

VELDWAARDEN Fysisch lineair

Ligger:basis bedding Fundamentele combinatie

Veld	Pos.	Grondspan. [kN/m2]		Dwarskr		Moment	
		min.	max.	min.	max.	min.	max.
1	7.000	49.32	104.71	1.23	6.77	-3.26	1.40
1	7.856					0.00	
1	8.072			0.00			
1	8.128						3.99
1	8.250	11.43					
1	8.405					1.17	
1	9.000		23.33				
1	9.250						2.39
1	9.305						2.39
1	9.438					0.00	
1	9.605				0.00		
1	10.750	49.99	102.56	-13.04	-1.19	-12.13	1.54
1	10.750	49.99	102.56	-13.04	-1.19	-12.13	1.54
1	10.912						0.00
1	11.200	50.02					
1	11.500			-106.16	-45.73	-54.26	-20.40
1	11.500			45.07	103.65	-54.26	-20.40
1	12.170						0.00
1	12.250	49.62	100.60	0.42	11.82	-13.44	0.60
1	12.250	49.62	100.60	0.42	11.82	-13.44	0.60
1	13.067						0.76
1	13.071			0.00			
1	13.982						0.61
1	14.185					0.00	
1	14.725					0.28	
1	15.429					0.00	
1	16.018			-0.52			
1	16.457				0.30		
1	18.510			0.00			
1	18.515					-1.22	
1	18.685	9.71					
1	20.308					0.00	
1	20.593			1.70			
1	21.407		19.83				
1	21.883			0.00			
1	21.984						11.40
1	22.150	51.88	87.72	-0.81	4.94	5.62	11.35
1	22.150	51.88	87.72	-0.81	4.94	5.62	11.35
1	22.251				0.00	5.86	
1	22.700			-34.77	-21.12		
1	22.750	56.01	92.42	-38.06	-23.47	0.00	0.00

OMHULLENDE VAN DE KARAKTERISTIEKE COMBINATIES

VERPLAATSINGEN [mm] Fys.NLE.kort Ligger:basis bedding Karakteristieke combinatie

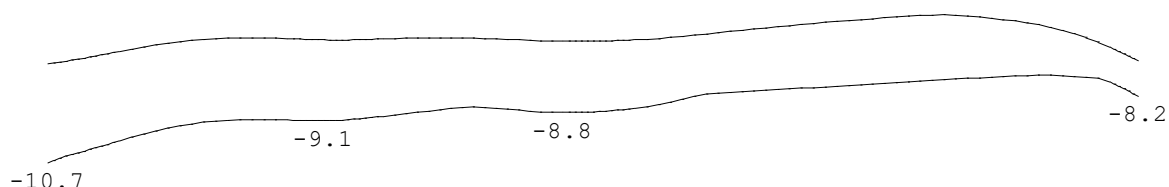

N.B. In deze verplaatsingen is de kruipvervorming (w_2) niet verwerkt!

PROFIELGEGEVENS Vloer [N] [mm] t.b.v. profiel:1 B*H 1000*200

Algemeen

Materiaal : C20/25

Doorsnede

breedte : 1000 hoogte : 200 zwaartepunt tov onderkant : 100
Fictieve dikte : 200.0

Betonkwaliteit element : C20/25 Kruipcoëf. : 3.010
Staalkwaliteit hoofdwapening : 500 ϵ_{uk} : 2.50
Staalkwaliteit beugels : 500

Betondekking

	Boven	Onder
Milieu	XC1	XC3
Hoofdwapening	2de laag	2de laag
Nominale dekking	15	30
Toegepaste dekking	33	38
Beugel / Verdeelwapening	1ste laag	1ste laag
Nominale dekking	15	30
Toegepaste dekking	25	30

Wapening

	Boven	Onder
Basiswapening	8-100	8-100
Hoofdwapening laag	2	2
Diameter verdeelwapening	8.0	8.0

Dwarskrachtwapening

Min. hoek betondrukdiagonaal θ : 21.8 z berekenen via: MRd

PROFIELGEGEVENS Vloer [N] [mm] t.b.v. profiel:2 B*H 2000*350

Algemeen

Materiaal : C20/25

Doorsnede

breedte : 2000 hoogte : 350 zwaartepunt tov onderkant : 175
Fictieve dikte : 350.0

Betonkwaliteit element : C20/25 Kruipcoëf. : 3.010
Staalkwaliteit hoofdwapening : 500 ϵ_{uk} : 2.50
Staalkwaliteit beugels : 500

Betondekking		Boven	Onder
Milieu	:	XC1	XC3
Hoofdwapening	:	2de laag	2de laag
Nominale dekking	:	15	30
Toegepaste dekking	:	35	50
Beugel / Verdeelwapening	:	1ste laag	1ste laag
Nominale dekking	:	15	30
Toegepaste dekking	:	25	40
Wapening		Boven	Onder
Basiswapening	:	8-100	10-100
Hoofdwapening laag	:	2	2
Diameter verdeelwapening	:	10.0	10.0
Dwarskrachtwapening			
Min. hoek betondrukdiagonaal θ	:	21.8	z berekenen via: MRd

PROFIELGEGEVENS Vloer [N] [mm] t.b.v. profiel:3 B*H 1000*550

Algemeen			
Materiaal	:	C20/25	
Doorsnede			
breedte : 1000	hoogte :	550	zwaartepunt tov onderkant : 275
Fictieve dikte	:	550.0	
Betonkwaliteit element	:	C20/25	Kruipcoëf. : 3.010
Staalkwaliteit hoofdwapening	:	500	ϵ_{uk} : 2.50
Staalkwaliteit beugels	:	500	
Betondekking		Boven	Onder
Milieu	:	XC1	XC3
Hoofdwapening	:	2de laag	2de laag
Nominale dekking	:	15	30
Toegepaste dekking	:	33	50
Beugel / Verdeelwapening	:	1ste laag	1ste laag
Nominale dekking	:	15	30
Toegepaste dekking	:	25	40
Wapening		Boven	Onder
Basiswapening	:	8-100	10-150
Hoofdwapening laag	:	2	2
Diameter verdeelwapening	:	8.0	10.0
Dwarskrachtwapening			
Min. hoek betondrukdiagonaal θ	:	21.8	z berekenen via: MRd

PROFIELGEGEVENS Vloer [N] [mm] t.b.v. profiel:4 B*H 1000*350

Algemeen			
Materiaal	:	C20/25	
Doorsnede			
breedte : 1000	hoogte :	350	zwaartepunt tov onderkant : 175
Fictieve dikte	:	350.0	
Betonkwaliteit element	:	C20/25	Kruipcoëf. : 3.010
Staalkwaliteit hoofdwapening	:	500	ϵ_{uk} : 2.50
Staalkwaliteit beugels	:	500	
Betondekking		Boven	Onder
Milieu	:	XC1	XC3
Hoofdwapening	:	2de laag	2de laag
Nominale dekking	:	15	30
Toegepaste dekking	:	33	50
Beugel / Verdeelwapening	:	1ste laag	1ste laag
Nominale dekking	:	15	30
Toegepaste dekking	:	25	40

Wapening		Boven	Onder
Basiswapening	:	8-100	10-150
Hoofdwapening laag	:	2	2
Diameter verdeelwapening	:	8.0	10.0

Dwarskrachtwapening

Min. hoek betondrukdiagonaal θ : 21.8 z berekenen via: MRd

PROFIELGEGEVENS Vloer [N] [mm] t.b.v. profiel:5 B*H 1500*350

Algemeen

Materiaal : C20/25

Doorsnede

breedte : 1500 hoogte : 350 zwaartepunt tov onderkant : 175
 Fictieve dikte : 350.0

Betonkwaliteit element	:	C20/25	Kruipcoëf.	:	3.010
Staalkwaliteit hoofdwapening	:	500	ϵ_{uk}	:	2.50
Staalkwaliteit beugels	:	500			

Betondekking

		Boven	Onder
Milieu	:	XC1	XC3
Hoofdwapening	:	2de laag	2de laag
Nominale dekking	:	15	30
Toegepaste dekking	:	35	50
Beugel / Verdeelwapening	:	1ste laag	1ste laag
Nominale dekking	:	15	30
Toegepaste dekking	:	25	40

Wapening

		Boven	Onder
Basiswapening	:	8-100	10-100
Hoofdwapening laag	:	2	2
Diameter verdeelwapening	:	10.0	10.0

Dwarskrachtwapening

Min. hoek betondrukdiagonaal θ : 21.8 z berekenen via: MRd

Hoofdwapening Fysisch lineair Ligger:basis bedding Fundamentele combinatie

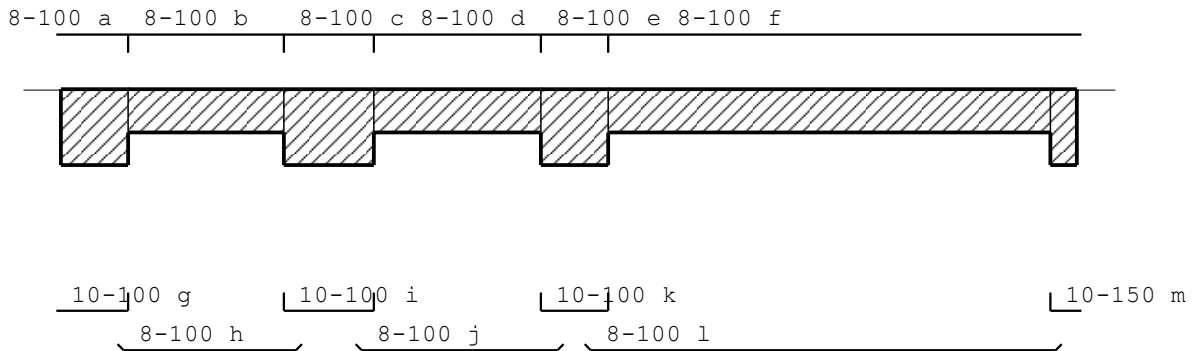

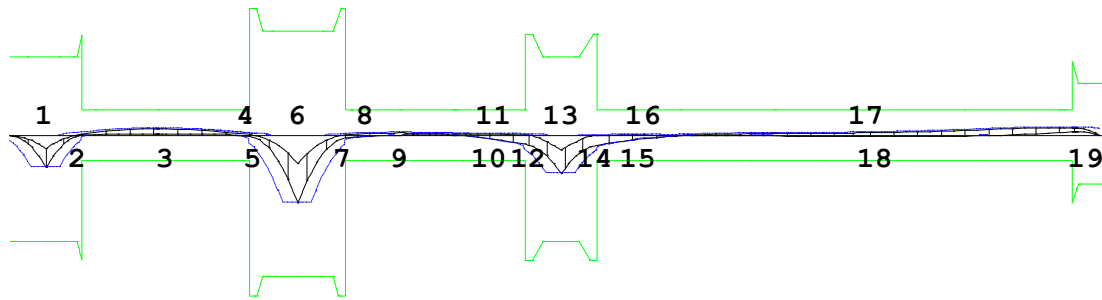

Hoofdwapening

Ligger:basis bedding

Geb.	Pos. [mm]	M _{E,d} [kNm]	M _{R,d} [kNm]	z [mm]	B/O	A _b [mm ²]	A _a [mm ²]	Basiswapening +Bijlegwapening	Opm.
1	750	-45.27	-150.79	263	Ond	449*	1179	10-100	54
2	1500	5.23	144.35	196	Bov	449*	755	8-100	54
3	3082	9.77	37.00	108	Bov	177*	503	8-100	54
4	5000	-4.36	-35.06	110	Ond	177*	503	8-100	54
5	5000	3.89	182.01	191	Bov	598*	1006	8-100	54
6	6000	-95.68	-201.06	263	Ond	868*	1572	10-100	1
7	7000	2.60	182.01	191	Bov	598*	1006	8-100	54
8	7000	-6.72	-35.06	110	Ond	177*	503	8-100	54
9	8128	3.99	37.00	108	Bov	177*	503	8-100	54
10	9305	2.67	37.00	108	Bov	177*	503	8-100	54
11	10750	-15.53	-35.06	110	Ond	279*	503	8-100	1
12	10750	1.86	144.38	196	Bov	449*	755	8-100	54
13	11500	-54.26	-150.79	263	Ond	518*	1179	10-100	1
14	12250	0.69	144.38	196	Bov	449*	755	8-100	54
15	13067	0.76	37.00	108	Bov	177*	503	8-100	54
16	12250	-16.62	-35.06	110	Ond	299*	503	8-100	1
17	18515	-1.22	-35.06	110	Ond	177*	503	8-100	54
18	21984	11.40	37.00	108	Bov	198*	503	8-100	1
19	22150	11.35	107.05	210	Bov	299*	503	8-100	54

Opmerkingen

[1] * = Eisen met betrekking tot minimum wapening zijn toegepast, zie nationale bijlage art. 9.2.1.1(1).

[54] * = Eisen met betrekking tot minimum wapening ten behoeve van gecontroleerde scheurvorming zijn toegepast volgens art. 7.3.2.

[93] De wapening bij de doorsnede overgang is niet getoetst vlg. NEN-EN 1992-1-1 art.9.9.

Scheurvorming volgens artikel 7.3.4

Ligger:basis bedding

Geb.	Pos. [mm]	Zijde	M _{E, freq} [kNm]	S _{r, max} [mm]	ε _{sm} -ε _{cm} [%]	w _k [mm]	k _x	w _{max} [mm]	U.C.	Opm.
1	3082	Bov	4.70	264	0.180	0.048	1.67	0.667	0.07	
1	5258	Bov	1.22	272	0.012	0.003	1.67	0.667	0.00	
1	8128	Bov	1.64	264	0.063	0.017	1.67	0.667	0.03	
1	21984	Bov	7.80	264	0.300	0.079	1.67	0.667	0.12	
1	750	Ond	-30.09	340	0.276	0.094	1.33	0.400	0.23	
1	965	Ond	-30.09	340	0.276	0.094	1.33	0.400	0.23	
1	5000	Ond	-2.19	272	0.088	0.024	1.00	0.300	0.08	
1	6000	Ond	-63.91	340	0.440	0.149	1.33	0.400	0.37	

Schuifspanningen

Ligger:basis bedding

Geb.	Vanaf [mm]	Tot [mm]	θ [°]	V_{Ed} [kN]	$V_{Ed} < V_{Rd}$	$V_{Rd} < V_{Rd, max}$	V_{opg} [N/mm ²]	Opm.
1	0	600	21.8	96	0.22	0.45	2.27	71
2	600	900	21.8	120	0.27	0.43	2.27	71
3	900	1500	21.8	96	0.22	0.45	2.27	71
4	1500	5000	21.8	10	0.06	0.50	1.69	71
5	5000	5550	21.8	104	0.18	0.45	2.27	71
6	5550	6450	21.8	184	0.31	0.41	2.27	71
7	6450	7000	21.8	101	0.17	0.44	2.27	71
8	7000	10750	21.8	13	0.08	0.51	1.78	71
9	10750	11050	21.8	49	0.11	0.44	2.23	71
10	11050	11950	21.8	106	0.24	0.41	2.27	71
11	11950	12250	21.8	47	0.11	0.44	2.23	71
12	12250	14050	21.8	12	0.07	0.51	1.78	71
13	14050	22150	21.8	5	0.03	0.50	1.69	71
14	22150	22750	21.8	38	0.12	0.37	1.57	71

Opmerkingen

[71] Er wordt voor platen geen minimale dwarskrachtwapening volgens art. 9.3.2 toegepast. Uitgangspunt hiervoor is dat er herverdeling van belastingen in dwarsrichting mogelijk is (zie art. 6.2.1(4)).

LIGGER:lage bedding poer

GEOMETRIE

Ligger:lage bedding poer

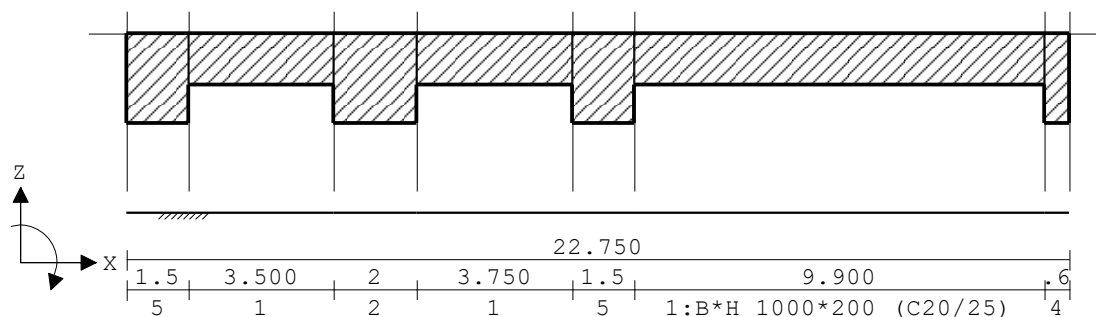

VELDLENGTEN

Ligger:lage bedding poer

Veld	Vanaf	Tot	Lengte
1	0.000	22.750	22.750

DOORSNEDEN

Ligger:lage bedding poer

sector	Vanaf	Tot	Lengte	Profiel begin	z-begin	Profiel eind	z-eind
1	0.000	1.500	1.500	5:B*H 1500*350	0.000	5:B*H 1500*350	0.000
2	1.500	5.000	3.500	1:B*H 1000*200	0.000	1:B*H 1000*200	0.000
3	5.000	7.000	2.000	2:B*H 2000*350	0.000	2:B*H 2000*350	0.000
4	7.000	10.750	3.750	1:B*H 1000*200	0.000	1:B*H 1000*200	0.000
5	10.750	12.250	1.500	5:B*H 1500*350	0.000	5:B*H 1500*350	0.000
6	12.250	22.150	9.900	1:B*H 1000*200	0.000	1:B*H 1000*200	0.000
7	22.150	22.750	0.600	4:B*H 1000*350	0.000	4:B*H 1000*350	0.000

sector	Vanaf	Tot	Lengte	Eindcode	Bedding	Br. [mm]
1	0.000	1.500	1.500	1:Vast	6900	1500
2	1.500	5.000	3.500	1:Vast	2750	1000
3	5.000	7.000	2.000	1:Vast	6900	2000
4	7.000	10.750	3.750	1:Vast	2750	1000
5	10.750	12.250	1.500	1:Vast	6900	1500
6	12.250	22.150	9.900	1:Vast	2750	1000
7	22.150	22.750	0.600	1:Vast	6900	1000

PROFIELVORMEN [mm]

1 B*H 1000*200

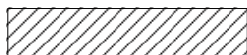

2 B*H 2000*350

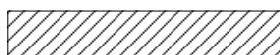

3 B*H 1000*550



4 B*H 1000*350

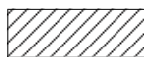

5 B*H 1500*350

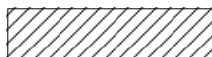

VELDBELASTINGEN

Ligger:lage bedding poer B.G:1 Permanent

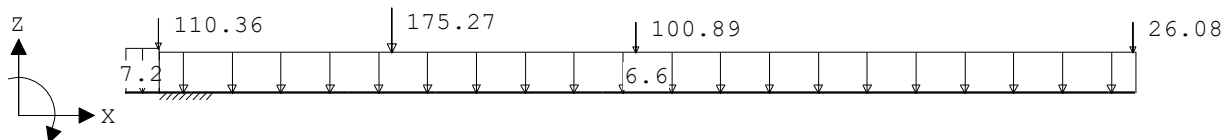

VELDBELASTINGEN

Ligger:lage bedding poer B.G:1 Permanent

Last Ref.	Type	Omschrijving	q1/p/m	q2 psi	Afstand	Lengte
1	1:q-last		-7.200	-7.200	0.000	0.750
2	1:q-last		-6.600	-6.600	0.750	22.000
3	8:Puntlast		-110.360		0.750	
4	8:Puntlast		-175.270		6.000	
5	8:Puntlast		-100.890		11.500	
6	8:Puntlast		-26.080		22.700	

VELDBELASTINGEN

Ligger:lage bedding poer B.G:2 Veranderlijk

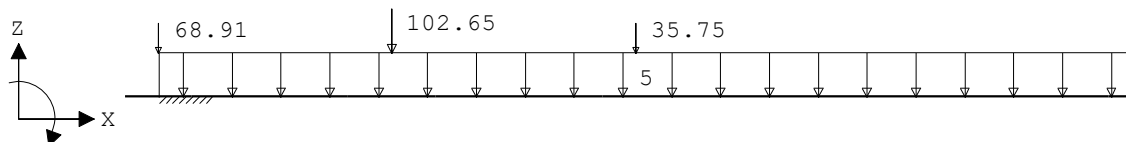

VELDBELASTINGEN

Ligger:lage bedding poer B.G:2 Veranderlijk

Last Ref.	Type	Omschrijving	q1/p/m	q2 psi	Afstand	Lengte
1	1:q-last		-5.000	-5.000	0.750	22.000
2	8:Puntlast		-68.910		0.750	
3	8:Puntlast		-102.650		6.000	
4	8:Puntlast		-35.750		11.500	

VELDBELASTINGEN

Ligger:lage bedding poer B.G:3 Sneeuw

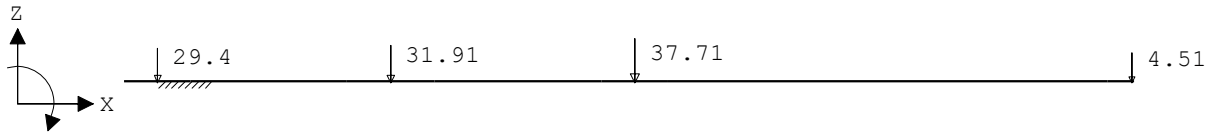

VELDBELASTINGEN

Ligger:lage bedding poer B.G:3 Sneeuw

Last Ref.	Type	Omschrijving	q1/p/m	q2 psi	Afstand	Lengte
1	8:Puntlast		-29.400		0.750	
2	8:Puntlast		-31.910		6.000	
3	8:Puntlast		-37.710		11.500	
4	8:Puntlast		-4.510		22.700	

OMHULLENDE VAN DE FUNDAMENTELE COMBINATIES

MOMENTEN Fysisch lineair

Ligger:lage bedding poer Fundamentele combinatie

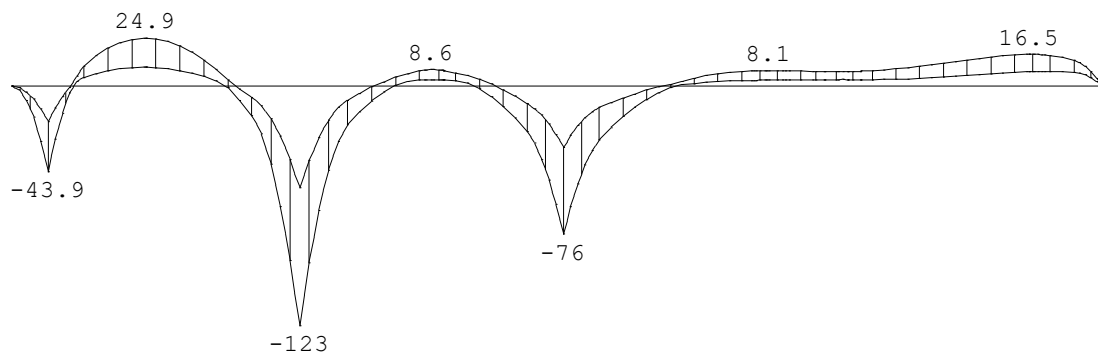

DWARSKRACHTEN Fysisch lineair

Ligger:lage bedding poer Fundamentele combinatie

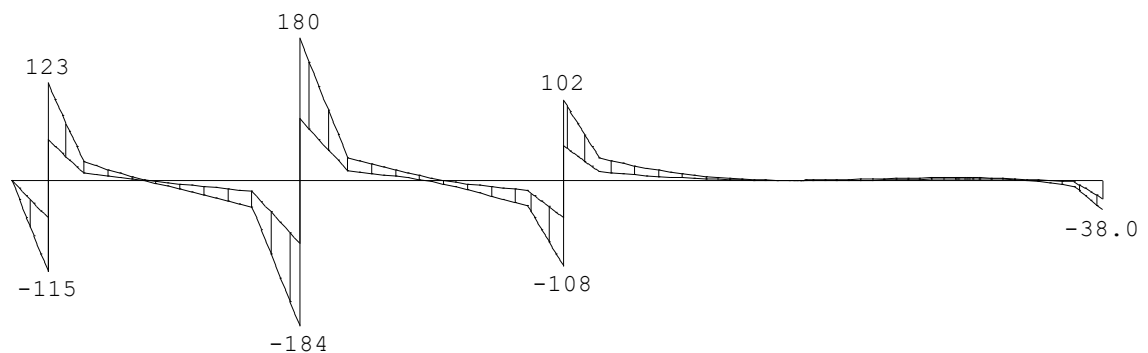

VELDWAARDEN Fysisch lineair

Ligger:lage bedding poer Fundamentele combinatie

Veld	Pos.	Grondspan. [kN/m2]		Dwarskr		Moment	
		min.	max.	min.	max.	min.	max.
1	0.000	56.43	124.30	0.00	0.00	0.00	0.00
1	0.750			-115.25	-47.37	-44.01	-18.06
1	0.750			51.95	123.31	-44.01	-18.06
1	1.217						0.00
1	1.284					0.00	
1	1.500	47.67	103.97	9.11	23.85	4.52	10.35
1	1.500	47.67	103.97	9.11	23.85	4.52	10.35
1	2.744			0.00			
1	2.750					9.91	
1	2.793						24.85
1	2.818				0.00		
1	3.500	16.44	35.72				
1	4.467					0.00	
1	4.681						0.00
1	5.000	43.01	93.05	-33.88	-14.04	-14.93	-5.69
1	5.000	43.01	93.05	-33.88	-14.04	-14.93	-5.69
1	6.000		94.39	-184.45	-79.43	-123.50	-52.26
1	6.000		94.39	78.31	179.84	-123.50	-52.26
1	6.400	44.03					
1	7.000	43.89	93.30	12.02	28.69	-19.63	-7.11
1	7.000	43.89	93.30	12.02	28.69	-19.63	-7.11
1	7.536						0.00
1	7.963					0.00	
1	8.600			0.00			
1	8.750						8.61
1	8.787					3.45	
1	9.000	16.84	34.20				
1	9.017				0.00		
1	9.647					0.00	
1	10.106						0.00
1	10.500	17.00	34.85				
1	10.750	42.53	87.22	-32.19	-12.71	-23.28	-8.96
1	10.750	42.53	87.22	-32.19	-12.71	-23.28	-8.96
1	11.500			-108.27	-46.84	-76.08	-31.35
1	11.500			43.96	101.54	-76.08	-31.35
1	12.250	40.42	82.29	11.01	28.23	-27.64	-10.83
1	12.250	40.42	82.29	11.01	28.23	-27.64	-10.83
1	13.534						0.00
1	13.846					0.00	
1	15.427			0.00			
1	15.793						8.05
1	16.210				0.17		
1	16.457			-0.60			
1	17.200						7.51
1	17.342					3.51	
1	17.714			0.00		3.46	
1	18.190	9.12	20.20				
1	19.746				3.51		
1	20.181			1.74			
1	21.199			0.00			
1	21.224						16.52
1	21.655					7.77	
1	21.660				0.00		
1	22.150	42.68	71.60	-7.68	-1.66	7.40	13.39

VELDWAARDEN		Fysisch lineair		Ligger:lage bedding poer Fundamentele combinatie			
Veld	Pos.	Grondspan. [kN/m ²]		Dwarskr		Moment	
		min.	max.	min.	max.	min.	max.
1	22.150	42.68	71.60	-7.68	-1.66	7.40	13.39
1	22.700			-35.31	-21.56		
1	22.750	49.14	81.18	-38.06	-23.47	0.00	0.00

OMHULLENDE VAN DE KARAKTERISTIEKE COMBINATIES

VERPLAATSINGEN [mm] Fys.NLE.kortLigger:lagebedding poer Karakteristieke combinatie

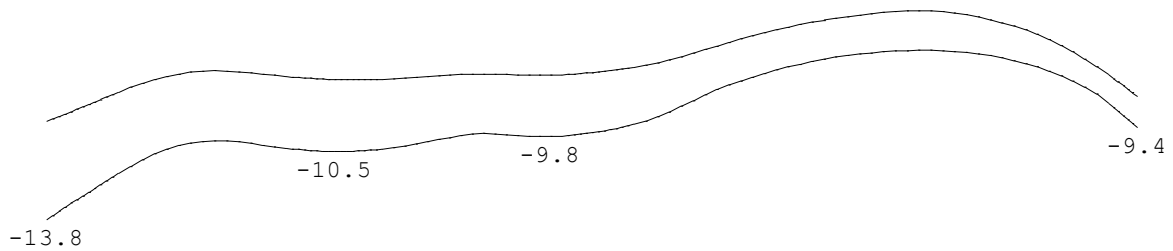

N.B. In deze verplaatsingen is de kruipvervorming (w2) niet verwerkt!

Hoofdwapening Fysisch lineair Ligger:lage bedding poer Fundamentele combinatie

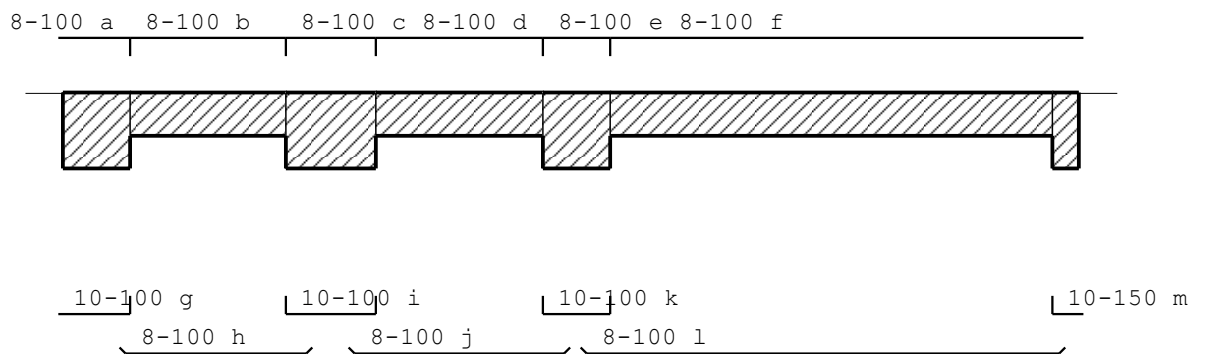

MEd dekkingslijn Fysisch lineair Ligger:lage bedding poer Fundamentele combinatie

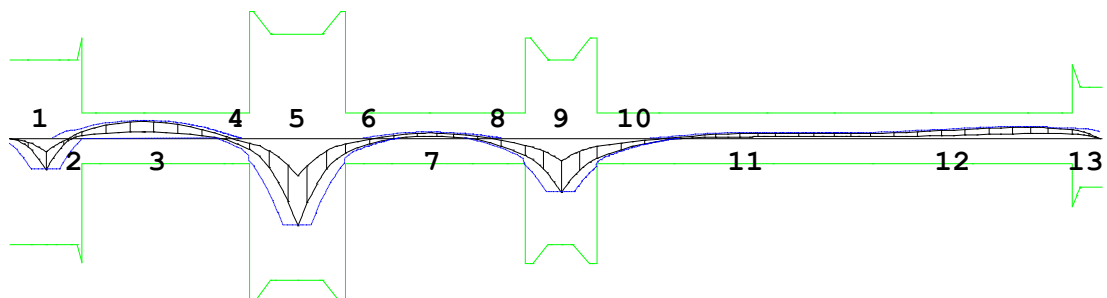

Hoofdwapening

Ligger:lage bedding poer

Geb.	Pos. [mm]	M_{Ed} [kNm]	M_{Rd} [kNm]	z B/O [mm]	A_b [mm ²]	A_a [mm ²]	Basiswapening +Bijlegwapening	Opm.
1	750	-44.01	-150.79	263 Ond	449*	1179	10-100	54
2	1500	16.62	144.35	196 Bov	449*	755	8-100	54
3	2793	24.85	37.00	108 Bov	350	503	8-100	
4	5000	-22.54	-35.06	110 Ond	327	503	8-100	
5	6000	-123.50	-201.06	263 Ond	952	1572	10-100	
6	7000	-26.47	-35.06	110 Ond	386	503	8-100	
7	8750	8.61	37.00	108 Bov	177*	503	8-100	54
8	10750	-29.71	-35.06	110 Ond	436	503	8-100	
9	11500	-76.08	-150.79	263 Ond	651*	1179	10-100	1
10	12250	-33.35	-35.06	110 Ond	492	503	8-100	
11	15793	8.05	37.00	108 Bov	177*	503	8-100	54
12	21224	16.52	37.00	108 Bov	288*	503	8-100	1
13	22150	15.22	107.05	210 Bov	299*	503	8-100	54

Opmerkingen

[1] * = Eisen met betrekking tot minimum wapening zijn toegepast, zie nationale bijlage art. 9.2.1.1(1).

[54] * = Eisen met betrekking tot minimum wapening ten behoeve van gecontroleerde scheurvorming zijn toegepast volgens art. 7.3.2.

[93] **De wapening bij de doorsnede overgang is niet getoetst vlg. NEN-EN 1992-1-1 art.9.9.**

Scheurvorming volgens artikel 7.3.4

Ligger:lage bedding poer

Geb.	Pos. [mm]	Zijde	$M_{E, freq}$ [kNm]	$S_{r, max}$ [mm]	$\epsilon_{sm} - \epsilon_{cm}$ [%]	W_k [mm]	k_x	W_{max} [mm]	U.C.	Opm.
1	2793	Bov	15.28	264	0.587	0.155	1.67	0.667	0.23	
1	8750	Bov	5.16	264	0.198	0.053	1.67	0.667	0.08	
1	15793	Bov	4.40	264	0.169	0.045	1.67	0.667	0.07	
1	21224	Bov	11.28	264	0.433	0.115	1.67	0.667	0.17	
1	750	Ond	-29.26	340	0.268	0.091	1.33	0.400	0.23	
1	965	Ond	-29.26	340	0.268	0.091	1.33	0.400	0.23	
1	5000	Ond	-14.78	272	0.590	0.161	1.00	0.300	0.54	
1	6000	Ond	-83.18	340	0.572	0.195	1.33	0.400	0.49	

Schuifspanningen

Ligger:lage bedding poer

Geb.	Vanaf [mm]	Tot [mm]	θ [°]	V_{Ed} [kN]	$V_{Ed} < V_{Rd} < V_{Rd, max}$ -----[N/mm ²]-----	V_{opg} [N/mm ²]	Opm.	
1	0	600	21.8	93	0.21	0.45	2.27	71
2	600	900	21.8	123	0.28	0.43	2.27	71
3	900	1500	21.8	102	0.23	0.45	2.27	71
4	1500	5000	21.8	34	0.21	0.51	1.78	71
5	5000	5550	21.8	116	0.20	0.41	2.27	71
6	5550	6450	21.8	184	0.31	0.39	2.27	71
7	6450	7000	21.8	111	0.19	0.41	2.27	71
8	7000	10750	21.8	32	0.20	0.51	1.78	71
9	10750	11050	21.8	63	0.14	0.43	2.17	71
10	11050	11950	21.8	108	0.24	0.39	2.27	71
11	11950	12250	21.8	57	0.13	0.42	2.15	71
12	12250	22150	21.8	28	0.18	0.51	1.78	71
13	22150	22750	21.8	38	0.12	0.37	1.57	71

Opmerkingen

[71] Er wordt voor platen geen minimale dwarskrachtwapening volgens art. 9.3.2 toegepast. Uitgangspunt hiervoor is dat er herverdeling van belastingen in dwarsrichting mogelijk is (zie art. 6.2.1(4)).

5.2.4 Doorsnede tussen as 3-4

Technosoft Liggers release 6.83a

18 dec 2025

Project.....: 10745
 Onderdeel....: Doorsnede tussen as 3-4
 Dimensies....: kN/m/rad
 Bestand.....: N:\Order\10000\10700\10745\berekeningen en schetsen\bgg
 dsn tussen as 3-4.dlw

Betrouwbaarheidsklasse : 2 Referentieperiode : 50
 Herverdelen van momenten : nee Maximale deellengte : 0.500
 Ouderdom bij belasten : 28 Relatieve vochtigheid : 50%
 Doorbuigingen(beton) zijn dmv gecorrigeerde stijfheden berekend.

Fysisch lineair : Er is gerekend met de e-modulus uit de materiaaltabel.
 Fys.NLE.kort : Er is gerekend met een gecorrigeerde e-modulus (korte duur).
 Deze e-mod. is berekend mbv de krachten uit de fysisch lineair berekening.

Toegepaste normen volgens Eurocode met Nederlandse NB

Belastingen	NEN-EN 1990:2002	C2:2010,A1:2019	NB:2019 (nl)
	NEN-EN 1991-1-1:2002	C1/C11:2019	NB:2019 (nl)
Beton	NEN-EN 1992-1-1:2011 (nl)	C2/A1:2020 (nl)	NB:2016 (nl)



LIGGER:basis bedding

GEOMETRIE

Ligger:basis bedding

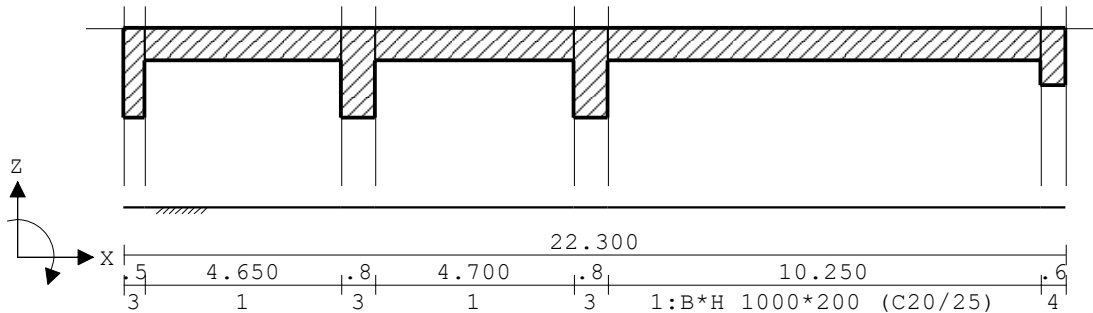

VELDLENGTEN

Ligger:basis bedding

Veld	Vanaf	Tot	Lengte
1	0.000	22.300	22.300

MATERIALEN

Mt	Kwaliteit	E-modulus[N/mm ²]	S.G.	Pois.	Uitz. coëff
1	C20/25	29962	25.0	0.20	1.0000e-05

MATERIALEN vervolg

Mt	Kwaliteit	Cement	Kruipfac.
1	C20/25	N	3.01

PROFIELEN [mm]

Prof.	Omschrijving	Materiaal	Oppervlak	Traagheid	Vormf.
1	B*H 1000*200	1:C20/25	2.0000e+05	6.6667e+08	0.00
2	B*H 2000*300	1:C20/25	6.0000e+05	4.5000e+09	0.00
3	B*H 1000*550	1:C20/25	5.5000e+05	1.3865e+10	0.00
4	B*H 1000*350	1:C20/25	3.5000e+05	3.5729e+09	0.00
5	B*H 1500*250	1:C20/25	3.7500e+05	1.9531e+09	0.00

PROFIELEN vervolg [mm]

Prof.	Staaftype	Breedte	Hoogte	e	Type	b1	h1	b2	h2
1	0:Normaal	1000	200	100.0	0:RH				
2	0:Normaal	2000	300	150.0	0:RH				
3	0:Normaal	1000	550	275.0	0:RH				
4	0:Normaal	1000	350	175.0	0:RH				
5	0:Normaal	1500	250	125.0	0:RH				

DOORSNEDEN

Ligger:basis bedding

sector	Vanaf	Tot	Lengte	Profiel begin	z-begin	Profiel eind	z-eind
1	0.000	0.500	0.500	3:B*H 1000*550	0.000	3:B*H 1000*550	0.000
2	0.500	5.150	4.650	1:B*H 1000*200	0.000	1:B*H 1000*200	0.000
3	5.150	5.950	0.800	3:B*H 1000*550	0.000	3:B*H 1000*550	0.000
4	5.950	10.650	4.700	1:B*H 1000*200	0.000	1:B*H 1000*200	0.000
5	10.650	11.450	0.800	3:B*H 1000*550	0.000	3:B*H 1000*550	0.000
6	11.450	21.700	10.250	1:B*H 1000*200	0.000	1:B*H 1000*200	0.000
7	21.700	22.300	0.600	4:B*H 1000*350	0.000	4:B*H 1000*350	0.000

sector	Vanaf	Tot	Lengte	Eindcode	Bedding	Br. [mm]
1	0.000	0.500	0.500	1:Vast	6900	1000
2	0.500	5.150	4.650	1:Vast	2750	1000
3	5.150	5.950	0.800	1:Vast	6900	1000
4	5.950	10.650	4.700	1:Vast	2750	1000
5	10.650	11.450	0.800	1:Vast	6900	1000
6	11.450	21.700	10.250	1:Vast	2750	1000
7	21.700	22.300	0.600	1:Vast	6900	1000

PROFIELVORMEN [mm]

1 B*H 1000*200

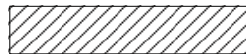

2 B*H 2000*300

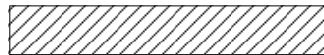

3 B*H 1000*550



4 B*H 1000*350

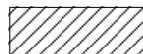

5 B*H 1500*250

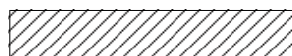

BELASTINGGEVALLEN

B.G.	Omschrijving	Belast/onbelast	Ψ_0	Ψ_1	Ψ_2	e.g.
1	Permanent	2:Permanent EN1991				-1.00
2	Veranderlijk	1:Schaakbord EN1991	0.60	0.70	0.60	0.00
3	Sneeuw	0:Alles tegelijk	0.00	0.20	0.00	0.00

BELASTINGGEVALLEN

B.G.	Omschrijving	Type
1	Permanent	1 Permanente belasting
2	Veranderlijk	2 Ver. bel. pers. ed. (q_k)
3	Sneeuw	22 Sneeuw A

VELDBELASTINGEN

Ligger:basis bedding B.G:1 Permanent

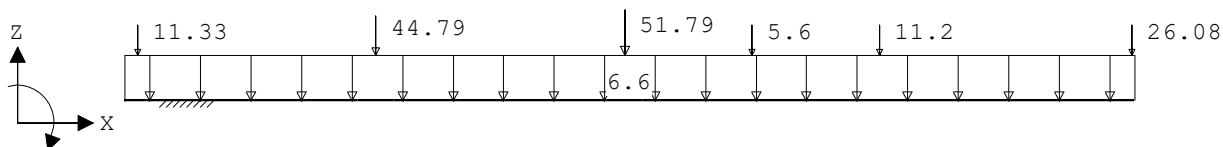

VELDBELASTINGEN

Ligger:basis bedding B.G:1 Permanent

Last Ref.	Type	Omschrijving	$q_1/p/m$	q_2	psi	Afstand	Lengte
1	1:q-last		-6.600	-6.600		0.000	22.300
2	8:Puntlast		-11.330			0.300	
3	8:Puntlast		-44.790			5.550	
4	8:Puntlast		-51.790			11.050	
5	8:Puntlast		-5.600			13.860	
6	8:Puntlast		-11.200			16.675	
7	8:Puntlast		-26.080			22.250	

VELDBELASTINGEN

Ligger:basis bedding B.G:2 Veranderlijk

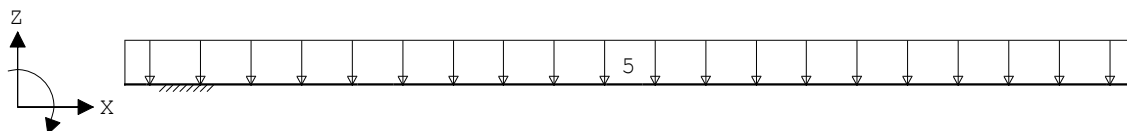

VELDBELASTINGEN

Ligger:basis bedding B.G:2 Veranderlijk

Last Ref.	Type	Omschrijving	$q_1/p/m$	q_2	psi	Afstand	Lengte
1	1:q-last		-5.000	-5.000		0.000	22.300

VELDBELASTINGEN

Ligger:basis bedding B.G:3 Sneeuw

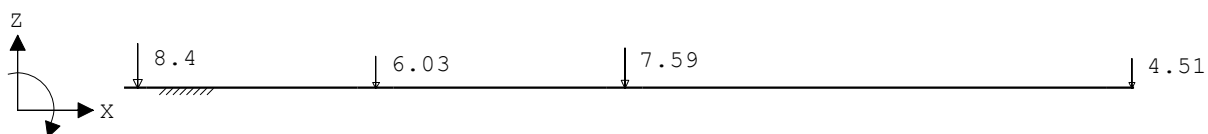

VELDBELASTINGEN

Ligger:basis bedding B.G:3 Sneeuw

Last Ref.	Type	Omschrijving	$q_1/p/m$	q_2	psi	Afstand	Lengte
1	8:Puntlast		-8.400			0.300	
2	8:Puntlast		-6.030			5.550	
3	8:Puntlast		-7.590			11.050	
4	8:Puntlast		-4.510			22.250	

BELASTINGCOMBINATIES

BC Type	BG Gen.	Factor	BG Gen.	Factor	BG Gen.	Factor	BG Gen.	Factor
1 Fund.	1 Perm	1.35						
2 Fund.	1 Perm	1.35	2 psi0	1.50				
3 Fund.	1 Perm	1.20	2 Extr	1.50				
4 Fund.	1 Perm	1.20	3 Extr	1.50				
5 Fund.	1 Perm	1.20	3 Extr	1.50	2 psi0	1.50		
6 Fund.	1 Perm	0.90						
7 Fund.	1 Perm	0.90	2 psi0	1.50				
8 Fund.	1 Perm	0.90	2 Extr	1.50				
9 Fund.	1 Perm	0.90	3 Extr	1.50				
10 Fund.	1 Perm	0.90	3 Extr	1.50	2 psi0	1.50		
11 Kar.	1 Perm	1.00	2 Extr	1.00				
12 Kar.	1 Perm	1.00	3 Extr	1.00				
13 Kar.	1 Perm	1.00	3 Extr	1.00	2 psi0	1.00		
14 Freq.	1 Perm	1.00						
15 Freq.	1 Perm	1.00	2 psi1	1.00				
16 Freq.	1 Perm	1.00	3 psi1	1.00				
17 Freq.	1 Perm	1.00	3 psi1	1.00	2 psi2	1.00		
18 Quas.	1 Perm	1.00						
19 Quas.	1 Perm	1.00	2 psi2	1.00				
20 Blij.	1 Perm	1.00						

GUNSTIGE WERKING PERMANENTE BELASTINGEN

BC Velden met gunstige werking
1 Geen
2 Geen
3 Geen
4 Geen
5 Geen
6 Alle velden de factor:0.90
7 Alle velden de factor:0.90
8 Alle velden de factor:0.90
9 Alle velden de factor:0.90
10 Alle velden de factor:0.90

OMHULLENDE VAN DE FUNDAMENTELE COMBINATIES

MOMENTEN Fysisch lineair

Ligger:basis bedding Fundamentele combinatie

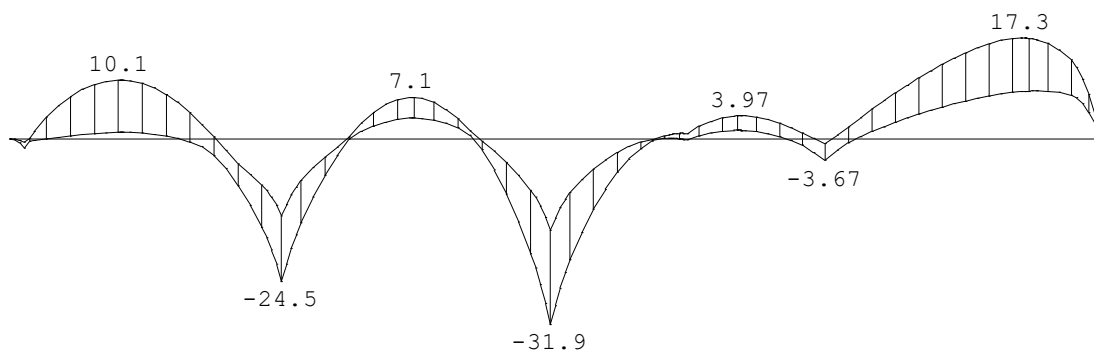

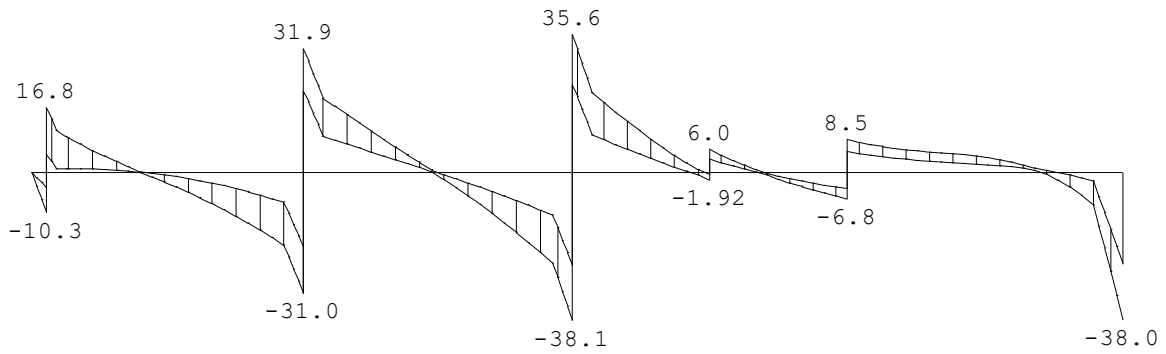

VELDWAARDEN Fysisch lineair

Ligger:basis bedding Fundamentele combinatie

Veld	Pos.	Grondspan. [kN/m ²]		Dwarskr		Moment	
		min.	max.	min.	max.	min.	max.
1	0.000	31.31	63.96	0.00	0.00	0.00	0.00
1	0.300			-10.34	-3.90	-1.56	-0.58
1	0.300			4.76	16.79	-1.56	-0.58
1	0.384						0.00
1	0.500	31.28	62.02	1.03	10.77	-0.23	1.33
1	0.500	31.28	62.02	1.03	10.77	-0.23	1.33
1	0.700			1.05			
1	0.722					0.00	
1	0.745	12.46					
1	1.968		23.19				
1	2.228			0.00			
1	2.244						10.10
1	2.325					1.12	
1	2.336				0.00		
1	3.468					0.00	
1	4.215						0.00
1	5.150	39.15	68.04	-18.60	-7.64	-15.22	-7.90
1	5.150	39.15	68.04	-18.60	-7.64	-15.22	-7.90
1	5.550			-31.04	-19.25	-24.57	-13.27
1	5.550			20.89	31.86	-24.57	-13.27
1	5.950	39.86	69.02	9.34	19.10	-14.39	-7.19
1	5.950	39.86	69.02	9.34	19.10	-14.39	-7.19
1	6.197	15.93	27.57				
1	6.886						0.00
1	6.953					0.00	
1	7.682	15.65	27.21				
1	8.204			0.00			
1	8.223						7.13
1	8.266					3.58	
1	8.307				0.00		
1	9.478					0.00	
1	9.600						0.00
1	10.650	42.94	73.52	-23.21	-10.96	-19.71	-8.79
1	10.650	42.94	73.52	-23.21	-10.96	-19.71	-8.79
1	10.850	42.94					
1	11.050			-38.12	-23.90	-31.98	-15.76
1	11.050			22.47	35.56	-31.98	-15.76
1	11.250		73.58				

VELDWAARDEN Fysisch lineair

Ligger:basis bedding Fundamentele combinatie

Veld	Pos.	Grondspan. [kN/m ²]		Dwarskr		Moment	
		min.	max.	min.	max.	min.	max.
1	11.450	42.89	73.57	9.73	20.55	-20.79	-9.27
1	11.450	42.89	73.57	9.73	20.55	-20.79	-9.27
1	13.181						0.00
1	13.325					0.00	
1	13.465					0.11	
1	13.467			0.00			
1	13.700					0.00	
1	13.742						0.97
1	13.779				0.00		
1	13.860			-1.92	-0.42	-0.20	0.92
1	13.860			3.47	5.96	-0.20	0.92
1	13.926					0.00	
1	14.857			0.00			
1	14.866					1.48	
1	14.957						3.97
1	14.980				0.00		
1	15.871					0.00	
1	16.484						0.00
1	16.675			-6.82	-4.18	-3.67	-0.76
1	16.675			5.38	8.45	-3.67	-0.76
1	16.808						0.00
1	17.313					0.00	
1	18.350	11.09					
1	19.068		22.42				
1	20.644			0.00			
1	20.675						17.34
1	21.001				0.00		
1	21.003					8.25	
1	21.700	42.18	70.86	-8.29	-2.15	7.56	13.60
1	21.700	42.18	70.86	-8.29	-2.15	7.56	13.60
1	22.250			-35.38	-21.61		
1	22.300	48.03	79.68	-38.06	-23.47	0.00	0.00

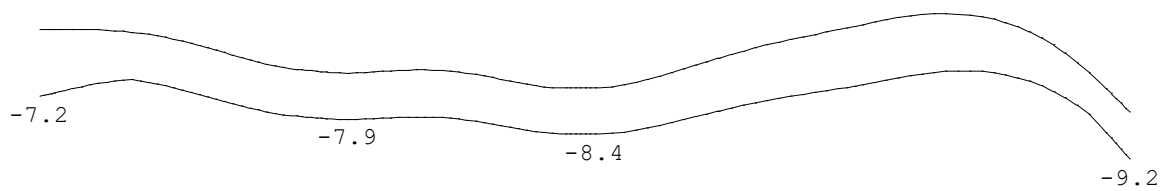
OMHULLENDE VAN DE KARAKTERISTIEKE COMBINATIES**VERPLAATSINGEN** [mm] Fys.NLE.kort Ligger:basis bedding Karakteristieke combinatieN.B. In deze verplaatsingen is de kruipvervorming (w₂) niet verwerkt!

PROFIELGEGEVENS Vloer [N] [mm] t.b.v. profiel:1 B*H 1000*200**Algemeen**

Materiaal : C20/25

Doorsnedebreedte : 1000 hoogte : 200 zwaartepunt tov onderkant : 100
Fictieve dikte : 200.0Betonkwaliteit element : C20/25 Kruipcoëf. : 3.010
Staal kwaliteit hoofdwapening : 500 ϵ_{uk} : 2.50
Staal kwaliteit beugels : 500**Betondekking**

	Boven	Onder
Milieu	XC1	XC3
Hoofdwapening	2de laag	2de laag
Nominale dekking	15	30
Toegepaste dekking	33	38
Beugel / Verdeelwapening	1ste laag	1ste laag
Nominale dekking	15	30
Toegepaste dekking	25	30

Wapening

	Boven	Onder
Basiswapening	8-100	8-100
Hoofdwapening laag	2	2
Diameter verdeelwapening	8.0	8.0

DwarskrachtwapeningMin. hoek betondrukdiagonaal θ : 21.8 z berekenen via: MRd**PROFIELGEGEVENS Vloer** [N] [mm] t.b.v. profiel:2 B*H 2000*300**Algemeen**

Materiaal : C20/25

Doorsnedebreedte : 2000 hoogte : 300 zwaartepunt tov onderkant : 150
Fictieve dikte : 300.0Betonkwaliteit element : C20/25 Kruipcoëf. : 3.010
Staal kwaliteit hoofdwapening : 500 ϵ_{uk} : 2.50
Staal kwaliteit beugels : 500**Betondekking**

	Boven	Onder
Milieu	XC1	XC3
Hoofdwapening	2de laag	2de laag
Nominale dekking	15	30
Toegepaste dekking	35	50
Beugel / Verdeelwapening	1ste laag	1ste laag
Nominale dekking	15	30
Toegepaste dekking	25	40

Wapening

	Boven	Onder
Basiswapening	8-100	10-100
Hoofdwapening laag	2	2
Diameter verdeelwapening	10.0	10.0

DwarskrachtwapeningMin. hoek betondrukdiagonaal θ : 21.8 z berekenen via: MRd**PROFIELGEGEVENS Vloer** [N] [mm] t.b.v. profiel:3 B*H 1000*550**Algemeen**

Materiaal : C20/25

Doorsnede

breedte : 1000 hoogte : 550 zwaartepunt tov onderkant : 275
Fictieve dikte : 550.0

Betonkwaliteit element	: C20/25	Kruipcoëf.	: 3.010
Staal kwaliteit hoofdwapening	: 500	ϵ_{uk}	: 2.50
Staal kwaliteit beugels	: 500		

Betondekking

	Boven	Onder
Milieu	: XC1	XC3
Hoofdwapening	: 2de laag	2de laag
Nominale dekking	: 15	30
Toegepaste dekking	: 33	50
Beugel / Verdeelwapening	: 1ste laag	1ste laag
Nominale dekking	: 15	30
Toegepaste dekking	: 25	40

Wapening

	Boven	Onder
Basiswapening	: 8-100	10-150
Hoofdwapening laag	: 2	2
Diameter verdeelwapening	: 8.0	10.0

Dwarskrachtwapening

Min. hoek betondrukdiagonaal θ : 21.8 z berekenen via: MRd

PROFIELGEGEVENS Vloer**[N] [mm]**t.b.v. profiel:4 B*H 1000*350

Algemeen

Materiaal : C20/25

Doorsnede

breedte : 1000 hoogte : 350 zwaartepunt tov onderkant : 175
Fictieve dikte : 350.0

Betonkwaliteit element	: C20/25	Kruipcoëf.	: 3.010
Staal kwaliteit hoofdwapening	: 500	ϵ_{uk}	: 2.50
Staal kwaliteit beugels	: 500		

Betondekking

	Boven	Onder
Milieu	: XC1	XC3
Hoofdwapening	: 2de laag	2de laag
Nominale dekking	: 15	30
Toegepaste dekking	: 33	50
Beugel / Verdeelwapening	: 1ste laag	1ste laag
Nominale dekking	: 15	30
Toegepaste dekking	: 25	40

Wapening

	Boven	Onder
Basiswapening	: 8-100	10-150
Hoofdwapening laag	: 2	2
Diameter verdeelwapening	: 8.0	10.0

Dwarskrachtwapening

Min. hoek betondrukdiagonaal θ : 21.8 z berekenen via: MRd

PROFIELGEGEVENS Vloer**[N] [mm]**t.b.v. profiel:5 B*H 1500*250

Algemeen

Materiaal : C20/25

Doorsnede

breedte : 1500 hoogte : 250 zwaartepunt tov onderkant : 125
Fictieve dikte : 250.0

Betonkwaliteit element	: C20/25	Kruipcoëf.	: 3.010
Staal kwaliteit hoofdwapening	: 500	ϵ_{uk}	: 2.50
Staal kwaliteit beugels	: 500		

Betondekking		Boven	Onder
Milieu	:	XC1	XC3
Hoofdwapening	:	2de laag	2de laag
Nominale dekking	:	15	30
Toegepaste dekking	:	35	50
Beugel / Verdeelwapening	:	1ste laag	1ste laag
Nominale dekking	:	15	30
Toegepaste dekking	:	25	40
Wapening		Boven	Onder
Basiswapening	:	8-100	10-100
Hoofdwapening laag	:	2	2
Diameter verdeelwapening	:	10.0	10.0
Dwarskrachtwapening			
Min. hoek betondrukdiagonaal θ	:	21.8	z berekenen via: MRd

Hoofdwapening Fysisch lineair Ligger:basis bedding Fundamentele combinatie

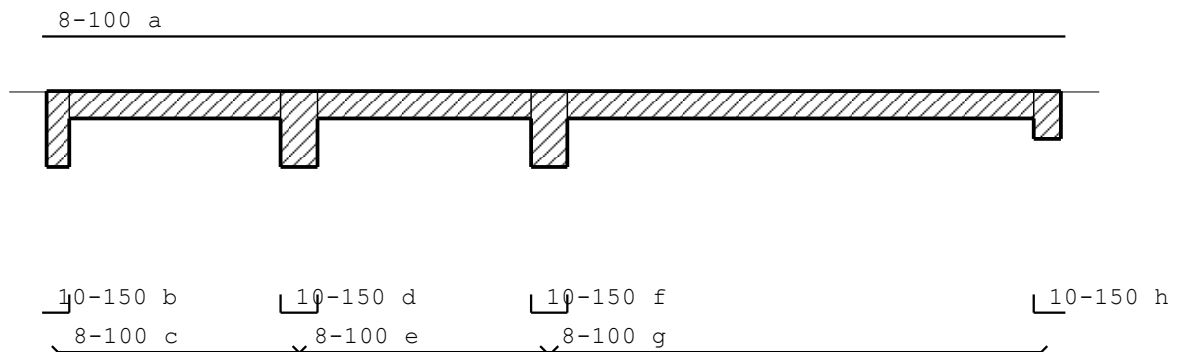

MED dekkingslijn Fysisch lineair Ligger:basis bedding Fundamentele combinatie

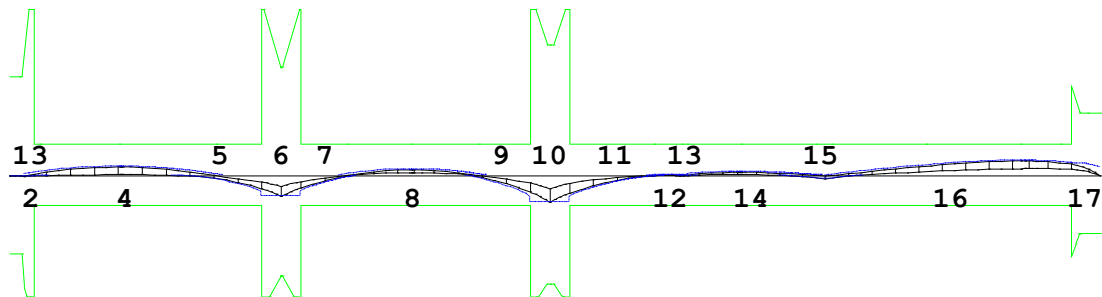

Hoofdwapening Ligger:basis bedding

Geb.	Pos. [mm]	$M_{E,d}$ [kNm]	$M_{R,d}$ [kNm]	z [mm]	B/O	A_b [mm ²]	A_a [mm ²]	Basiswapening +Bijlegwapening	Opm.
1	300	-1.56	-132.13	361	Ond	402*	524	10-150	54
2	500	5.88	197.67	411	Bov	402*	503	8-100	54
3	500	-1.09	-35.06	110	Ond	177*	503	8-100	54
4	2244	10.10	37.00	108	Bov	177*	503	8-100	54
5	5150	-18.26	-35.06	110	Ond	299*	503	8-100	1
6	5550	-24.57	-119.38	426	Ond	402*	524	10-150	54
7	5950	-17.85	-35.06	110	Ond	299*	503	8-100	1
8	8223	7.13	37.00	108	Bov	177*	503	8-100	54
9	10650	-23.89	-35.06	110	Ond	347	503	8-100	
10	11050	-31.98	-128.90	378	Ond	402*	524	10-150	54
11	11450	-24.54	-35.06	110	Ond	357	503	8-100	
12	13742	0.97	37.00	108	Bov	177*	503	8-100	54
13	13860	-0.20	-35.06	110	Ond	177*	503	8-100	54

Hoofdwapening

Ligger:basis bedding

Geb.	Pos. [mm]	M_{Ed} [kNm]	M_{Rd} [kNm]	z B/O [mm]	A_b [mm ²]	A_a [mm ²]	Basiswapening +Bijlegwapening	Opm.
14	14957	3.97	37.00	108 Bov	177*	503	8-100	54
15	16675	-3.67	-35.06	110 Ond	177*	503	8-100	54
16	20675	17.34	37.00	108 Bov	289*	503	8-100	1
17	21700	15.63	107.06	210 Bov	299*	503	8-100	54

Opmerkingen

[1] * = Eisen met betrekking tot minimum wapening zijn toegepast, zie nationale bijlage art. 9.2.1.1(1).

[54] * = Eisen met betrekking tot minimum wapening ten behoeve van gecontroleerde scheurvorming zijn toegepast volgens art. 7.3.2.

[93] **De wapening bij de doorsnede overgang is niet getoetst vlg. NEN-EN 1992-1-1 art.9.9.**

Scheurvorming volgens artikel 7.3.4

Ligger:basis bedding

Geb.	Pos. [mm]	Zijde	$M_{E, freq}$ [kNm]	$S_{r, max}$ [mm]	$\epsilon_{sm} - \epsilon_{cm}$ [‰]	w_k [mm]	k_x	w_{max} [mm]	U.C.	Opm.
1	2244	Bov	4.84	264	0.186	0.049	1.67	0.667	0.07	
1	8223	Bov	5.17	264	0.199	0.053	1.67	0.667	0.08	
1	14957	Bov	2.66	264	0.102	0.027	1.67	0.667	0.04	
1	20675	Bov	12.00	264	0.461	0.122	1.67	0.667	0.18	
1	0	Ond	-0.83	340	0.010	0.003	1.33	0.400	0.01	
1	242	Ond	-0.83	340	0.010	0.003	1.33	0.400	0.01	
1	342	Ond	-0.83	302	0.009	0.003	1.33	0.400	0.01	
1	435	Ond	-0.83	302	0.009	0.003	1.33	0.400	0.01	

Schuifspanningen

Ligger:basis bedding

Geb.	Vanaf [mm]	Tot [mm]	θ [°]	V_{Ed} [kN]	$V_{Ed} < V_{Rd} < V_{Rd, max}$ -----[N/mm ²]-----	V_{opg} [N/mm ²]	Opm.	
1	0	250	21.8	9	0.02	0.29	2.23	71
2	250	500	21.8	17	0.04	0.30	2.31	71
3	500	5150	21.8	19	0.12	0.51	1.78	71
4	5150	5400	21.8	26	0.05	0.30	1.80	71
5	5400	5700	21.8	32	0.06	0.29	2.19	71
6	5700	5950	21.8	27	0.05	0.30	1.81	71
7	5950	10650	21.8	23	0.15	0.51	1.78	71
8	10650	10900	21.8	32	0.07	0.30	1.77	71
9	10900	11200	21.8	38	0.08	0.29	1.94	71
10	11200	11450	21.8	30	0.06	0.30	1.77	71
11	11450	13725	21.8	21	0.13	0.51	1.78	71
12	13725	14025	21.8	6	0.04	0.52	1.69	71
13	14025	21700	21.8	8	0.05	0.50	1.69	71
14	21700	22300	21.8	38	0.12	0.37	1.57	71

Schuifspanningen

Ligger:basis bedding

Geb.	Vanaf [mm]	Tot [mm]	θ [°]	V_{Ed} [kN]	$V_{Rd,c}$	$V_{Rd,s}$	$V_{Ed} < V_{Rd} < V_{Rd,Max}$ [N/mm ²]	Opm.
------	---------------	-------------	-----------------	------------------	------------	------------	--	------

Opmerkingen

[71] Er wordt voor platen geen minimale dwarskrachtwapening volgens art. 9.3.2 toegepast. Uitgangspunt hiervoor is dat er herverdeling van belastingen in dwarsrichting mogelijk is (zie art. 6.2.1(4)).

LIGGER:lage bedding poer

GEOMETRIE

Ligger:lage bedding poer

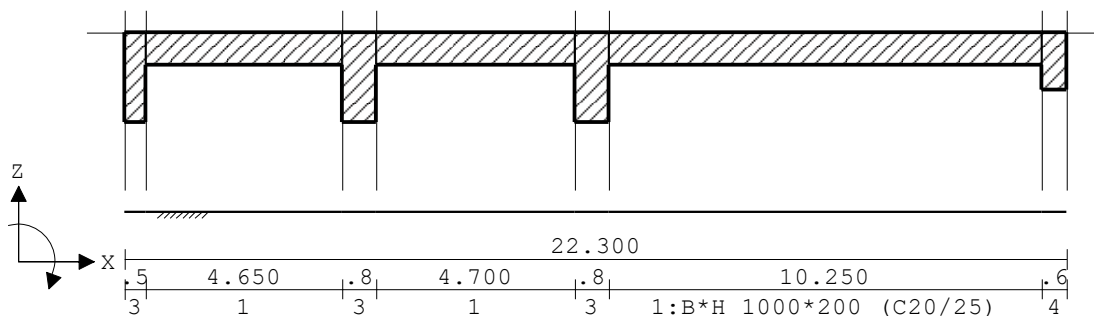

VELDLENGTEN

Ligger:lage bedding poer

Veld	Vanaf	Tot	Lengte
1	0.000	22.300	22.300

DOORSNEDEN

Ligger:lage bedding poer

sector	Vanaf	Tot	Lengte	Profiel begin	z-begin	Profiel eind	z-eind
1	0.000	0.500	0.500	3:B*H 1000*550	0.000	3:B*H 1000*550	0.000
2	0.500	5.150	4.650	1:B*H 1000*200	0.000	1:B*H 1000*200	0.000
3	5.150	5.950	0.800	3:B*H 1000*550	0.000	3:B*H 1000*550	0.000
4	5.950	10.650	4.700	1:B*H 1000*200	0.000	1:B*H 1000*200	0.000
5	10.650	11.450	0.800	3:B*H 1000*550	0.000	3:B*H 1000*550	0.000
6	11.450	21.700	10.250	1:B*H 1000*200	0.000	1:B*H 1000*200	0.000
7	21.700	22.300	0.600	4:B*H 1000*350	0.000	4:B*H 1000*350	0.000

sector	Vanaf	Tot	Lengte	Eindcode	Bedding	Br. [mm]
1	0.000	0.500	0.500	1:Vast	9000	1000
2	0.500	5.150	4.650	1:Vast	2100	1000
3	5.150	5.950	0.800	1:Vast	9000	1000
4	5.950	10.650	4.700	1:Vast	2100	1000
5	10.650	11.450	0.800	1:Vast	9000	1000
6	11.450	21.700	10.250	1:Vast	2100	1000
7	21.700	22.300	0.600	1:Vast	9000	1000

PROFIELVORMEN [mm]

1 B*H 1000*200

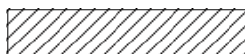

2 B*H 2000*300

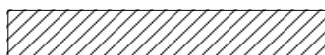

PROFIELVORMEN [mm]

3 B*H 1000*550



4 B*H 1000*350

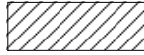

5 B*H 1500*250



VELDBELASTINGEN

Ligger:lage bedding poer B.G:1 Permanent

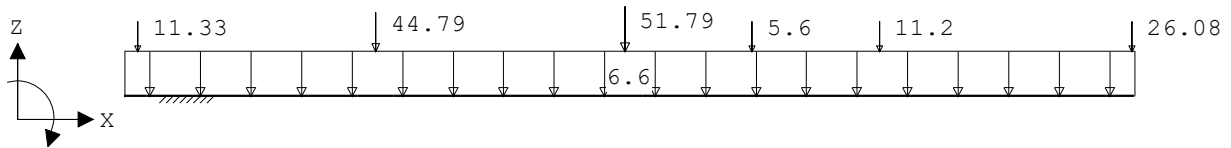

VELDBELASTINGEN

Ligger:lage bedding poer B.G:1 Permanent

Last Ref.	Type	Omschrijving	q1/p/m	q2 psi	Afstand	Lengte
1	1:q-last		-6.600	-6.600	0.000	22.300
2	8:Puntlast		-11.330		0.300	
3	8:Puntlast		-44.790		5.550	
4	8:Puntlast		-51.790		11.050	
5	8:Puntlast		-5.600		13.860	
6	8:Puntlast		-11.200		16.675	
7	8:Puntlast		-26.080		22.250	

VELDBELASTINGEN

Ligger:lage bedding poer B.G:2 Veranderlijk

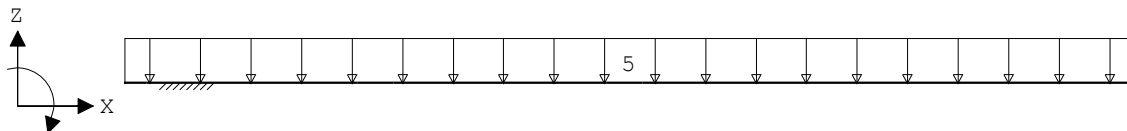

VELDBELASTINGEN

Ligger:lage bedding poer B.G:2 Veranderlijk

Last Ref.	Type	Omschrijving	q1/p/m	q2 psi	Afstand	Lengte
1	1:q-last		-5.000	-5.000	0.000	22.300

VELDBELASTINGEN

Ligger:lage bedding poer B.G:3 Sneeuw

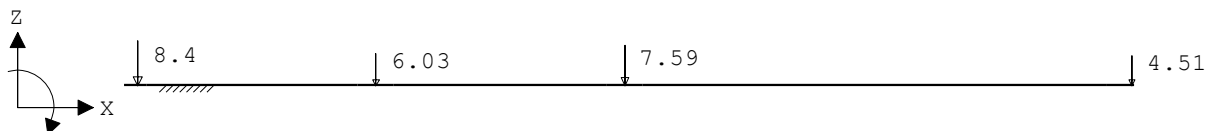

VELDBELASTINGEN

Ligger:lage bedding poer B.G:3 Sneeuw

Last Ref.	Type	Omschrijving	q1/p/m	q2	psi	Afstand	Lengte
1	8:Puntlast		-8.400			0.300	
2	8:Puntlast		-6.030			5.550	
3	8:Puntlast		-7.590			11.050	
4	8:Puntlast		-4.510			22.250	

OMHULLENDE VAN DE FUNDAMENTELE COMBINATIES

MOMENTEN Fysisch lineair

Ligger:lage bedding poer Fundamentele combinatie

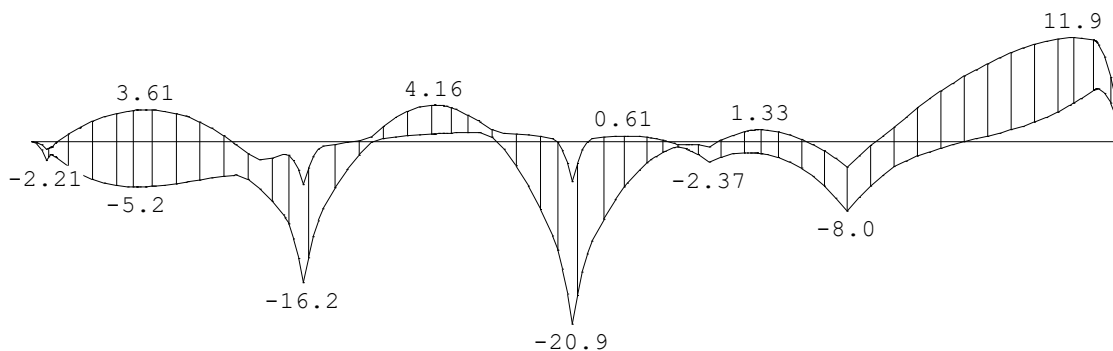

DWARSKRACHTEN Fysisch lineair

Ligger:lage bedding poer Fundamentele combinatie

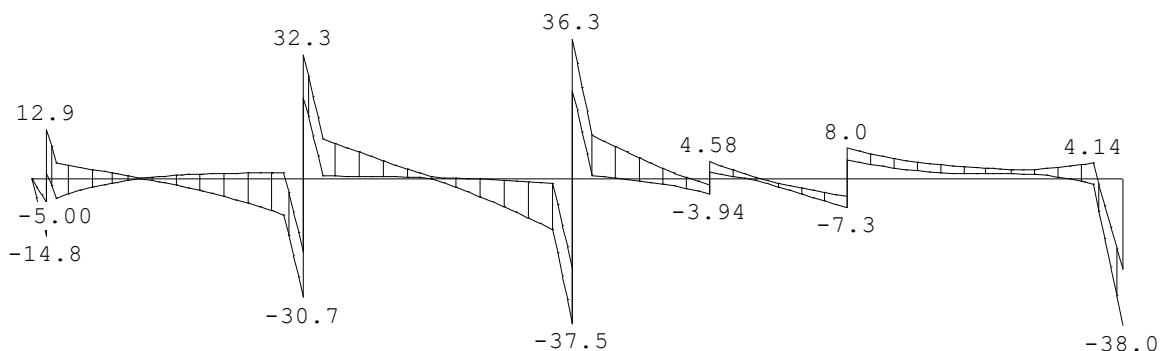

VELDWAARDEN Fysisch lineair

Ligger:lage bedding poer Fundamentele combinatie

Veld	Pos.	Grondspan. [kN/m ²]		Dwarskr		Moment	
		min.	max.	min.	max.	min.	max.
1	0.000	38.46	78.04	0.00	0.00	0.00	0.00
1	0.300			-14.85	-6.22	-2.22	-0.92
1	0.300			1.40	12.89	-2.22	-0.92
1	0.345			0.00			
1	0.400					-1.53	
1	0.500	40.44	79.33	-5.00	4.14	-1.83	-0.12
1	0.500	40.44	79.33	-5.00	4.14	-1.83	-0.12
1	0.531						0.00
1	2.148					-5.23	
1	2.180			0.00			
1	2.213			0.06	0.31		
1	2.253			0.00			
1	2.339						3.61
1	4.087						0.00
1	4.171					-3.86	

VELDWAARDEN Fysisch lineair

Ligger:lage bedding poer Fundamentele combinatie

Veld	Pos.	Grondspan. [kN/m2]		Dwarskr		Moment	
		min.	max.	min.	max.	min.	max.
1	4.661						-2.14
1	4.905				1.58		
1	5.150	54.96	95.67	-9.25	1.58	-8.40	-1.50
1	5.150	54.96	95.67	-9.25	1.58	-8.40	-1.50
1	5.181				0.00		-1.48
1	5.550			-30.72	-18.94	-16.22	-4.97
1	5.550			21.06	32.26	-16.22	-4.97
1	5.950	55.70	96.53	0.80	10.39	-7.72	-0.53
1	5.950	55.70	96.53	0.80	10.39	-7.72	-0.53
1	6.445	13.05					
1	6.661						0.00
1	6.989					0.00	
1	7.434	13.03					
1	8.201			0.00			
1	8.230						4.16
1	9.122				0.00		
1	9.124					1.02	
1	9.502					0.00	
1	10.650	59.62	102.25	-13.00	-1.07	-10.83	0.29
1	10.650	59.62	102.25	-13.00	-1.07	-10.83	0.29
1	10.727						0.00
1	11.050			-37.51	-23.26	-20.93	-4.56
1	11.050			22.90	36.29	-20.93	-4.56
1	11.370						0.00
1	11.450	60.16	103.47	0.91	11.42	-11.44	0.30
1	11.450	60.16	103.47	0.91	11.42	-11.44	0.30
1	11.691	14.05					
1	12.116			0.00			
1	12.117						0.61
1	12.984						0.00
1	13.214					-0.64	
1	13.378						-0.38
1	13.488						-0.35
1	13.489				0.00		
1	13.860			-3.94	-1.44	-2.37	-0.62
1	13.860			1.80	4.58	-2.37	-0.62
1	14.057						0.00
1	14.633			0.00		-1.32	
1	14.900						1.33
1	14.927				0.00		
1	15.502		24.87				
1	15.836						0.00
1	16.675			-7.34	-4.48	-7.96	-2.96
1	16.675			4.92	8.05	-7.96	-2.96
1	17.264						0.00
1	19.110					0.00	
1	19.324			1.37			
1	19.786	10.95		1.48			
1	20.264				2.36		
1	21.221		20.02				
1	21.228			0.00			
1	21.300						11.87
1	21.700	51.35	86.95	-1.34	4.14	5.83	11.61
1	21.700	51.35	86.95	-1.34	4.14	5.83	11.61

VELDWAARDEN		Fysisch lineair		Ligger:lage bedding poer Fundamentele combinatie			
Veld	Pos.	Grondspan. [kN/m2]		Dwarskr		Moment	
		min.	max.	min.	max.	min.	max.
1	21.789				0.00	6.02	
1	22.250			-34.86	-21.19		
1	22.300	54.53	90.50	-38.06	-23.47	0.00	0.00

OMHULLENDE VAN DE KARAKTERISTIEKE COMBINATIES

VERPLAATSINGEN [mm] Fys.NLE.kortLigger:lagebedding poer Karakteristieke combinatie

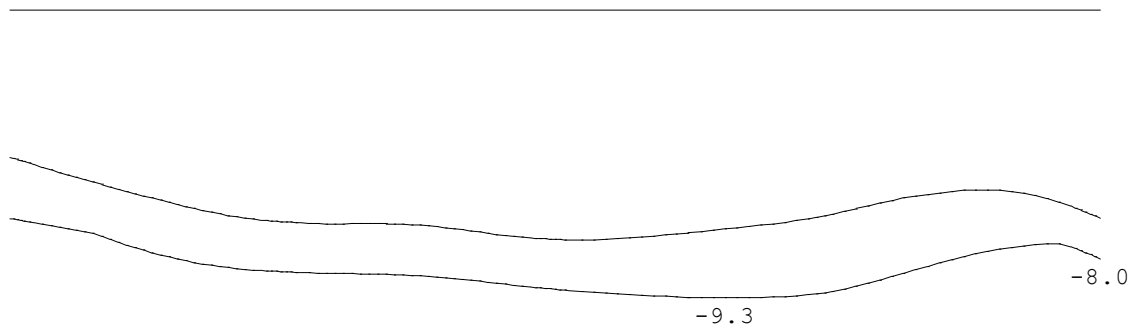

N.B. In deze verplaatsingen is de kruipvervorming (w2) niet verwerkt!

Hoofdwapening Fysisch lineair Ligger:lage bedding poer Fundamentele combinatie

8-100 a

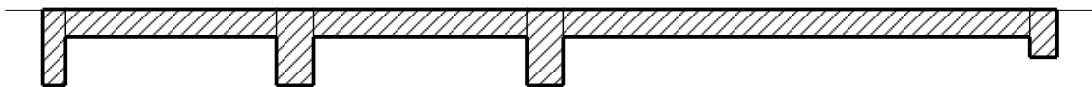

10-150 b 10-150 d 10-150 f 10-150 h
 8-100 c 8-100 e 8-100 g

MEd dekkingslijn Fysisch lineair Ligger:lage bedding poer Fundamentele combinatie

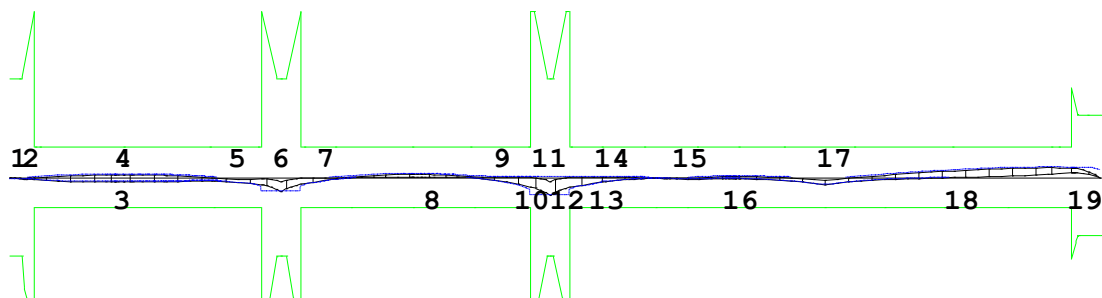

Hoofdwapening

Ligger:lage bedding poer

Geb.	Pos. [mm]	M_{Ed} [kNm]	M_{Rd} [kNm]	z B/O [mm]	A_b [mm ²]	A_a [mm ²]	Basiswapening +Bijlegwapening	Opm.
1	300	-2.22	-131.21	366 Ond	402*	524	10-150	54
2	500	-3.77	-143.88	314 Ond	402*	524	10-150	54
3	2339	3.61	37.00	108 Bov	177*	503	8-100	54
4	2148	-5.23	-35.06	110 Ond	177*	503	8-100	54
5	5150	-10.43	-35.06	110 Ond	187*	503	8-100	1
6	5550	-16.22	-92.85	447 Ond	402*	524	10-150	54
7	5950	-10.11	-35.06	110 Ond	181*	503	8-100	1
8	8230	4.16	37.00	108 Bov	177*	503	8-100	54
9	10650	-13.72	-35.06	110 Ond	247*	503	8-100	1
10	10650	0.72	197.67	411 Bov	402*	503	8-100	54
11	11050	-20.93	-92.85	447 Ond	402*	524	10-150	54
12	11450	0.59	197.67	411 Bov	402*	503	8-100	54
13	12117	0.61	37.00	108 Bov	177*	503	8-100	54
14	11450	-14.09	-35.06	110 Ond	253*	503	8-100	1
15	13860	-2.37	-35.06	110 Ond	177*	503	8-100	54
16	14900	1.33	37.00	108 Bov	177*	503	8-100	54
17	16675	-7.96	-35.06	110 Ond	177*	503	8-100	54
18	21300	11.87	37.00	108 Bov	206*	503	8-100	1
19	21700	11.85	107.05	210 Bov	299*	503	8-100	54

Opmerkingen

[1] * = Eisen met betrekking tot minimum wapening zijn toegepast, zie nationale bijlage art. 9.2.1.1(1).

[54] * = Eisen met betrekking tot minimum wapening ten behoeve van gecontroleerde scheurvorming zijn toegepast volgens art. 7.3.2.

[93] De wapening bij de doorsnede overgang is niet getoetst vlg. NEN-EN 1992-1-1 art.9.9.

Scheurvorming volgens artikel 7.3.4

Ligger:lage bedding poer

Geb.	Pos. [mm]	Zijde	$M_{E, freq}$ [kNm]	$S_{r, max}$ [mm]	$\epsilon_{sm} - \epsilon_{cm}$ [%]	W_k [mm]	k_x	W_{max} [mm]	U.C.	Opm.
1	2339	Bov	0.03	264	0.001	0.000	1.67	0.667	0.00	
1	8230	Bov	2.83	264	0.109	0.029	1.67	0.667	0.04	
1	14900	Bov	0.49	264	0.019	0.005	1.67	0.667	0.01	
1	21457	Bov	8.04	264	0.309	0.082	1.67	0.667	0.12	
1	0	Ond	-1.28	340	0.015	0.005	1.33	0.400	0.01	
1	245	Ond	-1.28	340	0.015	0.005	1.33	0.400	0.01	
1	5150	Ond	-7.72	272	0.308	0.084	1.00	0.300	0.28	
1	5252	Ond	-11.82	302	0.134	0.041	1.33	0.400	0.10	

Schuifspanningen

Ligger:lage bedding poer

Geb.	Vanaf [mm]	Tot [mm]	θ [°]	V_{Ed} [kN]	$V_{Ed} < V_{Rd} < V_{Rd, max}$ [N/mm ²]	V_{opg} [N/mm ²]	Opm.	
1	0	250	21.8	12	0.02	0.29	2.26	71
2	250	500	21.8	15	0.03	0.32	1.61	71
3	500	5150	21.8	9	0.06	0.51	1.78	71
4	5150	5400	21.8	22	0.05	0.30	2.02	71
5	5400	5700	21.8	32	0.07	0.29	2.29	71
6	5700	5950	21.8	24	0.05	0.30	2.05	71
7	5950	10650	21.8	13	0.08	0.51	1.78	71
8	10650	10900	21.8	28	0.06	0.31	1.91	71
9	10900	11200	21.8	38	0.08	0.29	2.29	71
10	11200	11450	21.8	27	0.05	0.31	1.90	71
11	11450	21700	21.8	11	0.07	0.50	1.69	71
12	21700	22300	21.8	38	0.12	0.37	1.57	71

Opmerkingen

[71] Er wordt voor platen geen minimale dwarskrachtwapening volgens art. 9.3.2 toegepast. Uitgangspunt hiervoor is dat er herverdeling van belastingen in dwarsrichting mogelijk is (zie art. 6.2.1(4)).

5.3 Berekening poeren

5.3.1 Poer as D1

$N_{Ed} = 500 \text{ kN}$

Technosoft Construct release 6.76

18 dec 2025

Datum : 28/11/2025
Eenheden : kN/m/rad
Bestand : N:\Order\10000\10700\10745\berekeningen en schetsen\wapening.cnw

Toegepaste normen volgens Eurocode met Nederlandse NB

Belastingen	NEN-EN 1990:2002	C2:2010,A1:2019	NB:2019(nl)
	NEN-EN 1991-1-1:2002	C1/C11:2019	NB:2019(nl)
Beton	NEN-EN 1992-1-1:2011(nl)	C2/A1:2020(nl)	NB:2016(nl)

Pons poer as D1

GEOMETRIE

Kolomvorm : Rechthoekig
Vorm omtrek : Rechthoekig
Kolomsoort : Midden - op de vloer - art. 6.4.4 (2) (6.50)
Betonkwaliteit : C20/25
Nuttige hoogte d [mm]: 310

Kolom

Breedte lastvlak c_1 [mm]: 500 Lengte lastvlak c_2 [mm]: 500

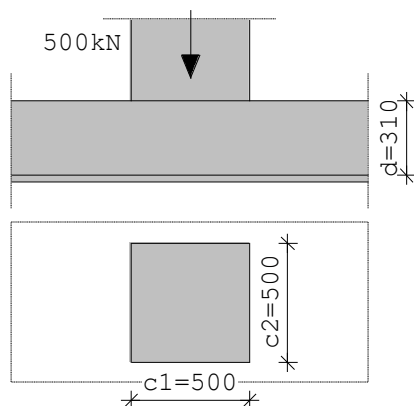

WAPENING

Langswapening in plaat			
y-richting	:10-100	z-richting	: 10-100
Strookbreedte y [mm]:	2360	Strookbreedte z [mm]:	2360
Wapeningsratio ρ_{1y}	: 0.00253	Wapeningsratio ρ_{1z}	: 0.00253
Staaalkwaliteit	: B500A		
Radiale afstand s_r [mm]:	232	Tangentiële afstand s_t [mm]:	465
Beugel diameter [mm]:	9	Hoek α	: 90

BELASTING

Kracht V_{Ed}	[kN]:	500.0		
Moment $M_{Ed,y}$	[kNm]:	0.0	Moment $M_{Ed,z}$	[kNm]: 0.0

RESULTATEN

Ponsomtrek	$V_{Rd,c}$	$V_{Rd,max}$	V_{Ed}	$V_{Rd,s}$	A_{sw}/s_r	A_{sw}	code
[mm]	[N/mm ²]	[N/mm ²]	[N/mm ²]	[N/mm ²]	[mm ² /mm]	[mm ²]	
u_0	2000	n.v.t.	2.94	0.81	n.v.t.	n.v.t.	n.v.t.
u_1	5896	0.38	2.94	0.27	0.00	0.00	0 [42]

Opmerkingen

[42] Er is geen ponswapening nodig ($v_{Ed} < v_{Rd,c}$).

$N_{Rd;pons} = 663 \text{ kN}$

$d_{eff} =$	$(dx + dy)/2 =$	$(295+305)/2 =$	300 mm
periferie $u_1 =$	$4*c+4*d_{eff}*pi =$	$4*500+4*300*3.142 =$	5770 mm
$u_{min} =$	$0.035*k^{2/3}*f_{ck}^{1/2} =$	$0.035*1.81649658092773^3/$	0.383 N/mm ²
$u_{Rd,c} =$	$C_{Rd,c}*k*(\eta*f_{ck})^{1/3} =$	$0.12*1.82*(0.262*20)^{1/3}*30$	0.379 N/mm ²
$V_{Rd,c} =$	$u*u_1*d =$	$0.383*5.77*300 =$	663.33 kN

$N_{Rd;geo} = 787 \text{ kN}$ (uit geo advies)

gronddruk [in rekenwaarde]

uit kolom	$500 / 2.0^2$		= 125.00 kN/m ²
beganegrondvloer	6.60	*1.2	= 7.92 kN/m ²
beganegrondvloer	5.00	*1.5	= 7.50 kN/m ²
e.g. poer	$25*0.35$	*1.2	= 10.50 kN/m ²
		Totaal	= 150.92 kN/m ²

Uit TS-ligger max 156 kN/m²

$M_{Ed} = 0.5 * 156 * 1.0^2 = 78 \text{ kNm}$

Technosoft Construct release 6.76

18 dec 2025

Datum : 28/11/2025
 Eenheden : kN/m/rad
 Bestand : N:\Order\10000\10700\10745\berekeningen en schetsen\wapening.cnw

Toegepaste normen volgens Eurocode met Nederlandse NB

Belastingen	NEN-EN 1990:2002	C2:2010,A1:2019	NB:2019(nl)
	NEN-EN 1991-1-1:2002	C1/C11:2019	NB:2019(nl)
Beton	NEN-EN 1992-1-1:2011(nl)	C2/A1:2020(nl)	NB:2016(nl)

Poerwapening D350mm**GEOMETRIE**

Elementtype : Vloer
 Betonkwaliteit : C20/25
 Soort spanningsrekdiagram : Parabolisch - rechthoekig diagram
 Doorsnede vorm : Rechthoek
 Afmetingen : b=1000 h=350
 Scheurvorming volgens art : 7.3.4
 Referentieperiode : 50 jaar

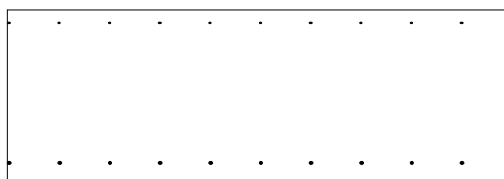

WAPENING

Staalkwaliteit	:	B500A	
Soort spanningsrekdiagram	:	Bi-lineair diagram met klimmende tak	
Toevallige inklemming	:	nee	
		Boven	Onder
Toegepaste wapening	:	8-100	10-100
Breedte stort sleuf	:	50	

Betondekking		Boven	Onder
Milieu	:	XC3	XC3
Gestort tegen bestaand beton	:	Nee	Nee
Element met plaatgeometrie	:	Ja	Ja
Specifieke kwaliteitsbeheersing	:	Nee	Nee
Oeffen beton oppervlak	:	Nee	Nee
Ondergrond	:	Glad / N.v.t.	Oeffen, voorbereid
	:		k1=30
Constructieklasse	:	S3	S3
Grootste korrel	:	31.5	

Betondekking		Boven	Onder
Hoofdwapening	:	1ste laag	1ste laag
Nominale dekking	:	25	30
Toegepaste dekking	:	25	40
Gelijkwaardige diameter	:	8	10
$C_{min,b}$ $C_{min,dur}$ ΔC_{dur}	:	8 20 0	10 20 0
C_{min} ΔC_{dev} C_{nom}	:	20 5 25	20 5 30

BELASTING**RESULTATEN**

Nr					Sterkte		Scheurvorming		Opm.
	N_{Ed} [kN]	M_{Ed} [kNm]	$N_{E;freq}$ [kN]	$M_{E;freq}$ [kNm]	M_{Rd} [kNm]	M_{Rd} [kNm]	$M_{R;freq}$ [kNm]	$M_{R;freq}$ [kNm]	
1	0.0	0.0	0.0	0.0	74.0	-103.7	54.6	-79.9	

5.3.2 Poer as B2 en B3

$$N_{Ed;B2} = 365 \text{ kN}$$

$$N_{Ed;B3} = 320 + (65 \cdot 2.00) = \pm 450 \text{ kN}$$

Kies afmeting 2000x2000x350 mm met wapening gelijk aan poer as D1.

5.3.3 Poer as E1

$$N_{Ed} = 335 \text{ kN}$$

Kies afmeting 2000x1500x350 mm met wapening gelijk aan poer as D1.

5.3.4 Overige poeren

Maatgevend as C1

$$N_{Ed} = 290 \text{ kN}$$

Kies afmeting 1500x1500x350 mm met wapening gelijk aan poer as D1.

gronddruk [in rekenwaarde]

uit kolom	$290 / 1.5^2$		= 128.89 kN/m ²
beganegrondvloer	6.60	*1.2	= 7.92 kN/m ²
beganegrondvloer	5.00	*1.5	= 7.50 kN/m ²
e.g. poer	$25 * 0.35$	*1.2	= 10.50 kN/m ²
		Totaal	= 154.81 kN/m ²

$$N_{Rd,geo} = 482 \text{ kN (uit geo advies } 1.50 \times 1.50 \text{ m}^2)$$

$$M_{Ed} = 0.5 * 155 * 0.75^2 = 43.6 \text{ kNm}$$

$$M_{Rd} = 103.7 \text{ kNm}$$

5.3.5 Poer tpv dakoverstek

Reacties uit paragraaf 3.6 Kolommen dakoverstek stramien A/1.

<i>blijvend</i>			
grond	$18 * 0.35 * (2.00-1.20)$	=	5.04 kN/m ¹
opstort	$25 * (0.35+0.40) * 1.20$	=	22.50 kN/m ¹
		Totaal	= 27.54 kN/m ¹
grond	$18 * 0.35 * 2.00$	=	12.60 kN/m ¹

Technosoft Liggers release 6.83a

18 dec 2025

Project.....: 10745
 Onderdeel....: Poer tpv dakoverstek
 Dimensies....: kN/m/rad
 Bestand.....: N:\Order\10000\10700\10745\berekeningen en schetsen\poer
 tpv dakoverstek.dlw

Betrouwbaarheidsklasse : 2 Referentieperiode : 50
 Herverdelen van momenten : nee Maximale deellengte : 0.500
 Ouderdom bij belasten : 28 Relatieve vochtigheid : 50%
 Doorbuigingen(beton) zijn dmv gecorrigeerde stijfheden berekend.

Fysisch lineair : Er is gerekend met de e-modulus uit de materiaaltabel.
 Fys.NLE.kort : Er is gerekend met een gecorrigeerde e-modulus (korte duur).
 Deze e-mod. is berekend mbv de krachten uit de fysisch lineair berekening.

Toegepaste normen volgens Eurocode met Nederlandse NB

Belastingen	NEN-EN 1990:2002	C2:2010,A1:2019	NB:2019 (nl)
	NEN-EN 1991-1-1:2002	C1/C11:2019	NB:2019 (nl)
Beton	NEN-EN 1992-1-1:2011 (nl)	C2/A1:2020 (nl)	NB:2016 (nl)



GEOMETRIE

Ligger:ligger1

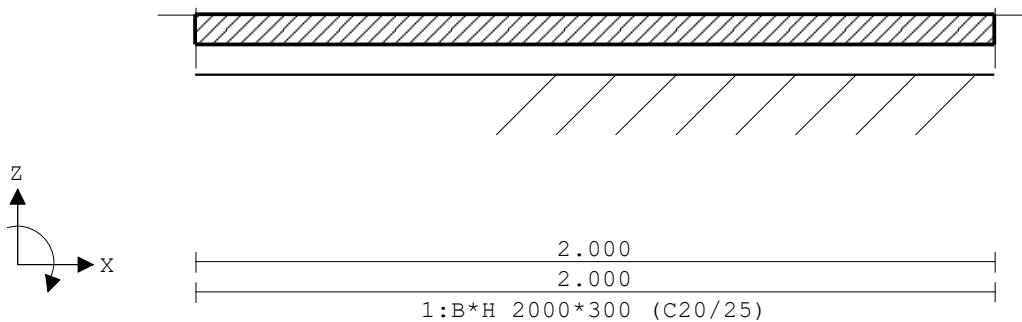

VELDLENGTEN

Ligger:ligger1

Veld	Vanaf	Tot	Lengte
1	0.000	2.000	2.000

MATERIALEN

Mt	Kwaliteit	E-modulus [N/mm ²]	S.G.	Pois.	Uitz. coëff
1	C20/25	29962	25.0	0.20	1.0000e-05

MATERIALEN vervolg

Mt	Kwaliteit	Cement	Kruipfac.
1	C20/25	N	3.01

PROFIELEN [mm]

Prof.	Omschrijving	Materiaal	Oppervlak	Traagheid	Vormf.
1	B*H 2000*300	1:C20/25	6.0000e+05	4.5000e+09	0.00

PROFIELEN vervolg [mm]

Prof.	Staaftype	Breedte	Hoogte	e	Type	b1	h1	b2	h2
1	0:Normaal	2000	300	150.0	0:RH				

DOORSNEDEN

Ligger:ligger1

sector	Vanaf	Tot	Lengte	Profiel begin	z-begin	Profiel eind	z-eind
1	0.000	2.000	2.000	1:B*H 2000*300	0.000	1:B*H 2000*300	0.000

sector	Vanaf	Tot	Lengte	Eindcode	Bedding	Br. [mm]
1	0.000	2.000	2.000	1:Vast	9000	2000

PROFIELVORMEN [mm]

1 B*H 2000*300



BELASTINGGEVALLEN

B.G.	Omschrijving	Belast/onbelast	Ψ_0	Ψ_1	Ψ_2	e.g.
1	Permanent	2:Permanent EN1991				-1.00
2	Wind	0:Alles tegelijk	0.00	0.20	0.00	0.00
3	Sneeuw	0:Alles tegelijk	0.00	0.20	0.00	0.00

BELASTINGGEVALLEN

B.G.	Omschrijving	Type
1	Permanent	1 Permanente belasting
2	Wind	7 Wind van links onderdruk A
3	Sneeuw	22 Sneeuw A

VELDBELASTINGEN

Ligger:ligger1 B.G:1 Permanent

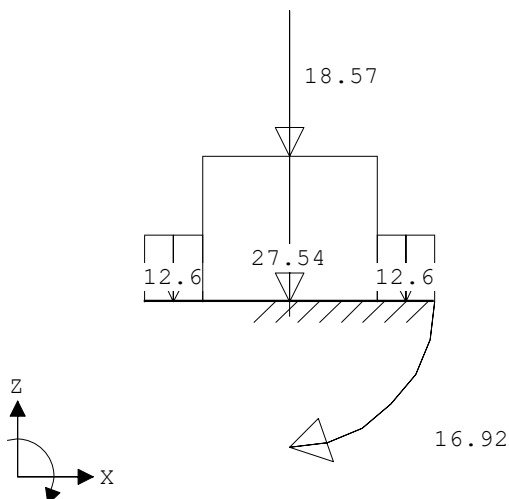

ELDBELASTINGEN

Ligger:ligger1 B.G:1 Permanent

Last Ref.	Type	Omschrijving	q1/p/m	q2	psi	Afstand	Lengte
1	1:q-last		-27.540	-27.540		0.400	1.200
2	1:q-last		-12.600	-12.600		0.000	0.400
3	1:q-last		-12.600	-12.600		1.600	0.400
4	8:Puntlast		-18.570			1.000	
5	12:Moment		16.920			1.000	

VELDBELASTINGEN

Ligger:ligger1 B.G:2 Wind

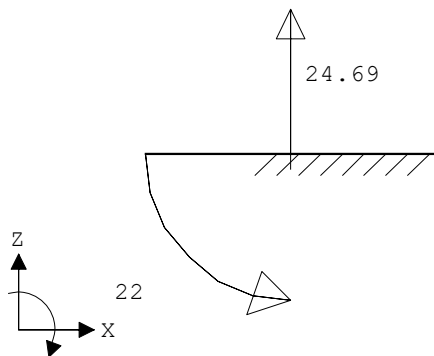

VELDBELASTINGEN

Ligger:ligger1 B.G:2 Wind

Last Ref.	Type	Omschrijving	q1/p/m	q2	psi	Afstand	Lengte
1	8:Puntlast		24.690			1.000	
2	12:Moment		-22.000			1.000	

VELDBELASTINGEN

Ligger:ligger1 B.G:3 Sneeuw

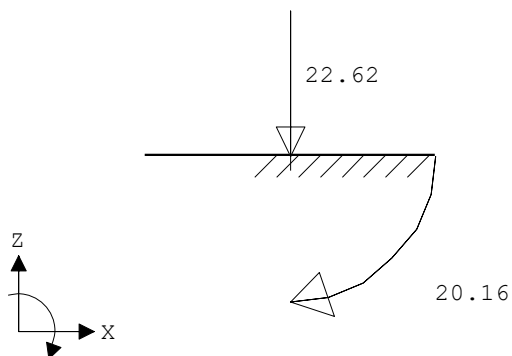

VELDBELASTINGEN

Ligger:ligger1 B.G:3 Sneeuw

Last Ref.	Type	Omschrijving	q1/p/m	q2	psi	Afstand	Lengte
1	8:Puntlast		-22.620			1.000	
2	12:Moment		20.160			1.000	

BELASTINGCOMBINATIES

BC	Type	BG	Gen.	Factor	BG	Gen.	Factor	BG	Gen.	Factor	BG	Gen.	Factor
1	Fund.	1	Perm	1.35									
2	Fund.	1	Perm	1.20	2	Extr	1.50						
3	Fund.	1	Perm	1.20	3	Extr	1.50						
4	Fund.	1	Perm	0.90									
5	Fund.	1	Perm	0.90	2	Extr	1.50						
6	Fund.	1	Perm	0.90	3	Extr	1.50						
7	Kar.	1	Perm	1.00	2	Extr	1.00						
8	Kar.	1	Perm	1.00	3	Extr	1.00						

BELASTINGCOMBINATIES

BC Type	BG Gen.	Factor	BG Gen.	Factor	BG Gen.	Factor	BG Gen.	Factor
9 Freq.	1 Perm	1.00						
10 Freq.	1 Perm	1.00	2 psi1	1.00				
11 Freq.	1 Perm	1.00	3 psi1	1.00				
12 Quas.	1 Perm	1.00						
13 Blij.	1 Perm	1.00						

GUNSTIGE WERKING PERMANENTE BELASTINGEN

BC Velden met gunstige werking
1 Geen
2 Geen
3 Geen
4 Alle velden de factor:0.90
5 Alle velden de factor:0.90
6 Alle velden de factor:0.90

OMHULLENDE VAN DE FUNDAMENTELE COMBINATIES

MOMENTEN Fysisch lineair

Ligger:ligger1 Fundamentele combinatie

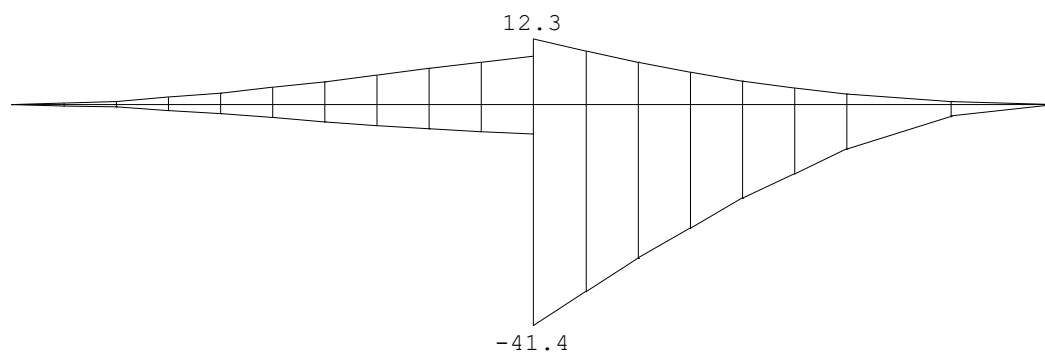

DWARSKRACHTEN Fysisch lineair

Ligger:ligger1 Fundamentele combinatie

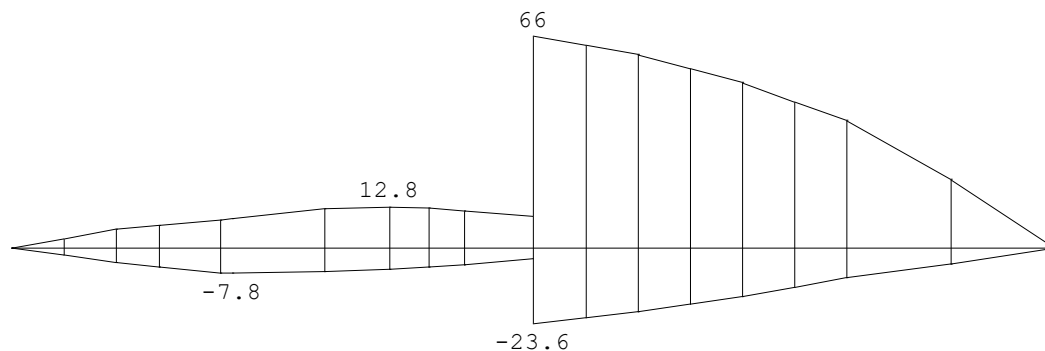

VELDWAARDEN Fysisch lineair

Ligger:ligger1 Fundamentele combinatie

Veld	Pos.	Grondspan. [kN/m2]		Dwarskr		Moment	
		min.	max.	min.	max.	min.	max.
1	0.000		27.76	0.00	0.00	0.00	0.00
1	0.400		23.97				
1	0.423			-7.80			
1	0.600	14.90					
1	0.724				12.77		
1	1.000			-3.26	9.84	-5.51	9.11
1	1.000			-23.58	66.06	-41.44	12.26

VELDWAARDEN Fysisch lineair

Ligger:ligger1 Fundamentele combinatie

Veld	Pos.	Grondspan. [kN/m2]		Dwarskr		Moment	
		min.	max.	min.	max.	min.	max.
1	2.000		73.68	-0.00	0.00	-0.00	0.00

PROFIELGEGEVENS Vloer

[N] [mm]

t.b.v. profiel:1 B*H 2000*300

Algemeen

Materiaal : C20/25

Doorsnede

breedte : 2000 hoogte : 300 zwaartepunt tov onderkant : 150
 Fictieve dikte : 300.0

Betonkwaliteit element : C20/25 Kruipcoëf. : 3.010
 Staalkwaliteit hoofdwapening : 500 ϵ_{uk} : 2.50
 Staalkwaliteit beugels : 500

Betondekking

	Boven	Onder
Milieu	XC3	XC3
Hoofdwapening	2de laag	2de laag
Nominale dekking	25	30
Toegepaste dekking	45	50
Beugel / Verdeelwapening	1ste laag	1ste laag
Nominale dekking	25	30
Toegepaste dekking	35	40

Wapening

	Boven	Onder
Basiswapening	8-100	10-100
Hoofdwapening laag	2	2
Diameter verdeelwapening	10.0	10.0

DwarskrachtwapeningMin. hoek betondrukdiagonaal θ : 21.8 z berekenen via: MRd**Hoofdwapening** Fysisch lineair

Ligger:ligger1 Fundamentele combinatie

8-100 a



10-100 b

MED dekkingslijn Fysisch lineair

Ligger:ligger1 Fundamentele combinatie



Hoofdwapening

Ligger:ligger1

Geb.	Pos. [mm]	M_{Ed} [kNm]	M_{Rd} [kNm]	z B/O [mm]	A_b [mm ²]	A_a [mm ²]	Basiswapening +Bijlegwapening	Opm.
1	1000	12.26	121.86	141 Bov	531*	1006	8-100	54
2	1000	-41.44	-166.43	192 Ond	531*	1572	10-100	54

Opmerkingen

[54] * = Eisen met betrekking tot minimum wapening ten behoeve van gecontroleerde scheurvorming zijn toegepast volgens art. 7.3.2.

Scheurvorming volgens artikel 7.3.4

Ligger:ligger1

Geb.	Pos. [mm]	Zijde	$M_{E, freq}$ [kNm]	$S_{r, max}$ [mm]	$\epsilon_{sm} - \epsilon_{cm}$ [%]	w_k [mm]	k_x	w_{max} [mm]	U.C.	Opm.
1	0	Bov	0.28	272	0.003	0.001	1.40	0.420	0.00	
1	684	Bov	2.65	272	0.033	0.009	1.40	0.420	0.02	
1	1000	Bov	2.92	272	0.036	0.010	1.40	0.420	0.02	
1	1000	Ond	-17.94	340	0.149	0.051	1.33	0.400	0.13	
1	1377	Ond	-14.61	340	0.121	0.041	1.33	0.400	0.10	

Schuifspanningen

Ligger:ligger1

Geb.	Vanaf [mm]	Tot [mm]	θ [°]	V_{Ed} [kN]	$V_{Ed} < V_{Rd} < V_{Rd, max}$ [N/mm ²]	V_{opg} [N/mm ²]	Opm.	
1	0	1150	21.8	66	0.13	0.43	1.99	71
2	1150	2000	21.8	62	0.13	0.45	1.99	71

Opmerkingen

[71] Er wordt voor platen geen minimale dwarskrachtwapening volgens art. 9.3.2 toegepast. Uitgangspunt hiervoor is dat er herverdeling van belastingen in dwarsrichting mogelijk is (zie art. 6.2.1(4)).

5.4 Berekening wapening balken

Technosoft Construct release 6.76

1 dec 2025

Datum : 28/11/2025
Eenheden : kN/m/rad
Bestand : N:\Order\10000\10700\10745\berekeningen en schetsen\wapening.cnw

Toegepaste normen volgens Eurocode met Nederlandse NB

Belastingen	NEN-EN 1990:2002	C2:2010,A1:2019	NB:2019 (nl)
	NEN-EN 1991-1-1:2002	C1/C11:2019	NB:2019 (nl)
Beton	NEN-EN 1992-1-1:2011 (nl)	C2/A1:2020 (nl)	NB:2016 (nl)

wapening gevelbalk

GEOMETRIE

Elementtype : Balk
Betonkwaliteit : C20/25
Soort spanningsrekdiagram : Parabolisch - rechthoekig diagram
Doorsnede vorm : L2
Afmetingen : b=500 h=550 b1=165 h1=200
Scheurvorming volgens art : 7.3.4
Referentieperiode : 50 jaar

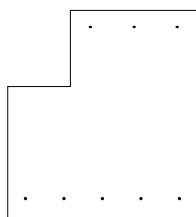

WAPENING

Staalkwaliteit : B500B
Soort spanningsrekdiagram : Bi-lineair diagram met klimmende tak
Beugeldiameter : 8
Toevallige inklemming : nee

Toegepaste wapening	:	Boven	Onder
Breedte stort sleuf	:	3x10	5x10
	:	50	

Betondekking

Milieu	:	Boven	Onder
	:	XC3	XC3
Gestort tegen bestaand beton	:	Nee	Nee
Element met plaatgeometrie	:	Nee	Nee
Specifieke kwaliteitsbeheersing	:	Nee	Nee
Oneffen beton oppervlak	:	Nee	Nee
Ondergrond	:	Glad / N.v.t.	Oneffen, voorbereid
	:		k1=35
Constructieklasse	:	S4	S4
Grootste korrel	:	31.5	

Betondekking

		Boven			Onder		
Hoofdwapening	:	2de laag			2de laag		
Nominale dekking	:	30			35		
Toegepaste dekking	:	43			48		
Gelijkwaardige diameter	:	10			10		
$C_{min,b}$ $C_{min,dur}$ ΔC_{dur}	:	10	25	0	10	25	0
C_{min} ΔC_{dev} C_{nom}	:	25	5	30	25	5	35
Beugel / Verdeelwapening	:	1ste laag			1ste laag		
Nominale dekking	:	30			35		
Toegepaste dekking	:	35			40		
Gelijkwaardige diameter	:	8			8		
$C_{min,b}$ $C_{min,dur}$ ΔC_{dur}	:	8	25	0	8	25	0
C_{min} ΔC_{dev} C_{nom}	:	25	5	30	25	5	35

BELASTING**RESULTATEN**

Nr	N_{Ed}		M_{Ed}		Sterkte		Scheurvorming		Opm.
	[kN]	[kNm]	$N_{E;freq}$ [kN]	$M_{E;freq}$ [kNm]	M_{Rd} [kNm]	M_{Rd} [kNm]	$M_{R;freq}$ [kNm]	$M_{R;freq}$ [kNm]	
1	0.0	0.0	0.0	0.0	56.8	-85.4	39.2	-62.0	

dwarskracht gevelbalk**GEOMETRIE**

Elementtype	:	Balk
Betonkwaliteit	:	C20/25
Soort spanningsrekdiagram	:	Parabolisch - rechthoekig diagram
Doorsnede vorm	:	L2
Afmetingen	:	b=500 h=550 b1=165 h1=200
Referentieperiode	:	50 jaar

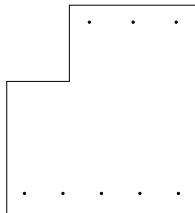
**WAPENING**

Staalkwaliteit	:	B500B
Soort spanningsrekdiagram	:	Bi-lineair diagram met klimmende tak
Toevallige inklemming	:	nee
Toegepaste wapening	:	Boven 3x10
Breedte stortsluif	:	Onder 5x10
		50

Betondekking		Boven	Onder
Milieu	:	XC3	XC3
Gestort tegen bestaand beton	:	Nee	Nee
Element met plaatgeometrie	:	Nee	Nee
Specifieke kwaliteitsbeheersing	:	Nee	Nee
Oneffen beton oppervlak	:	Nee	Nee
Ondergrond	:	Glad / N.v.t.	Glad / N.v.t.
Constructieklasse	:	S4	S4
Grootste korrel	:	31.5	
Hoofdwapening	:	2de laag	2de laag
Nominale dekking	:	30	30
Toegepaste dekking	:	43	48
Gelijkwaardige diameter	:	10	10
$C_{min,b}$ $C_{min,dur}$ ΔC_{dur}	:	10 25 0	10 25 0
C_{min} ΔC_{dev} C_{nom}	:	25 5 30	25 5 30
Beugel / Verdeelwapening	:	1ste laag	1ste laag
Nominale dekking	:	30	30
Toegepaste dekking	:	35	40
Gelijkwaardige diameter	:	8	8
$C_{min,b}$ $C_{min,dur}$ ΔC_{dur}	:	8 25 0	8 25 0
C_{min} ΔC_{dev} C_{nom}	:	25 5 30	25 5 30
Minimale beugelafstand	:	50	Theta [graden] : 21.8
Uitg.p. inw.hefboomsarm z	:	MRd	

BELASTING

Trek aan de	:	onderzijde
N_d [kN]	:	0.0

Dwarskrachten [kN] bij verschillende beugels en hoh-afstanden

Diameter [mm]	Bgls. /drsn	z [mm]	H.o.h.-afstanden beugels [mm]	
			300	200
8.0	2	476.3	173.49	260.23

Diameter [mm]	Bgls. /drsn	$V_{Rd,c}$ [kN]	$V_{Rd,max}$ [kN]
8.0	2	54.76	404.90

wapening tussenbalk b800mm

GEOMETRIE

Elementtype	:	Balk
Betonkwaliteit	:	C20/25
Soort spanningsrekdiagram	:	Parabolisch - rechthoekig diagram
Doorsnede vorm	:	Rechthoek
Afmetingen	:	b=800 h=550
Scheurvorming volgens art	:	7.3.4
Referentieperiode	:	50 jaar

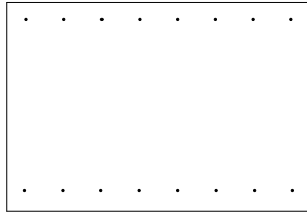

WAPENING

Staalkwaliteit	:	B500B					
Soort spanningsrekdiagram	:	Bi-lineair diagram met klimmende tak					
Beugeldiameter	:	8					
Toevallige inklemming	:	nee					
		Boven			Onder		
Toegepaste wapening	:	8x10			8x10		
Breedte stortstleuf	:	50					
Betondekking		Boven			Onder		
Milieu	:	XC3			XC3		
Gestort tegen bestaand beton	:	Nee			Nee		
Element met plaatgeometrie	:	Nee			Nee		
Specifieke kwaliteitsbeheersing	:	Nee			Nee		
Oneffen beton oppervlak	:	Nee			Nee		
Ondergrond	:	Glad / N.v.t.			Oneffen, voorbereid		
	:				k1=35		
Constructieklasse	:	S4			S4		
Grootste korrel	:	31.5					
Hoofdwapening	:	2de laag			2de laag		
Nominale dekking	:	30			35		
Toegepaste dekking	:	43			48		
Gelijkwaardige diameter	:	10			10		
$C_{min,b}$ $C_{min,dur}$ ΔC_{dur}	:	10	25	0	10	25	0
C_{min} ΔC_{dev} C_{nom}	:	25	5	30	25	5	35
Beugel / Verdeelwapening	:	1ste laag			1ste laag		
Nominale dekking	:	30			35		
Toegepaste dekking	:	35			40		
Gelijkwaardige diameter	:	8			8		
$C_{min,b}$ $C_{min,dur}$ ΔC_{dur}	:	8	25	0	8	25	0
C_{min} ΔC_{dev} C_{nom}	:	25	5	30	25	5	35

BELASTING

RESULTATEN

Nr	Sterkte				Scheurvorming		Opm.
	N_{Ed} [kN]	M_{Ed} [kNm]	$N_{E,freq}$ [kN]	$M_{E,freq}$ [kNm]	$M_{R,freq}$ [kNm]	$M_{R,freq}$ [kNm]	
1	0.0	0.0	0.0	0.0	142.9	-141.1	103.2 -100.2

dwarskracht tussenbalk b800mm

GEOMETRIE

Elementtype	:	Balk
Betonkwaliteit	:	C20/25
Soort spanningsrekdiagram	:	Parabolisch - rechthoekig diagram
Doorsnede vorm	:	Rechthoek

Afmetingen : b=800 h=550
 Referentieperiode : 50 jaar

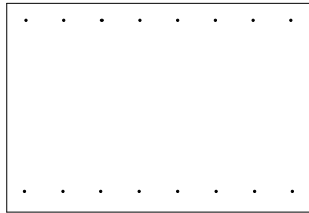

WAPENING

Staalqualiteit	:	B500B					
Soort spanningsrekdiagram	:	Bi-lineair diagram met klimmende tak					
Toevallige inklemming	:	nee					
Toegepaste wapening	:	Boven		Onder			
Breedte stort sleuf	:	8x10		8x10			
	:	50					
Betondekking		Boven		Onder			
Milieu	:	XC3		XC3			
Gestort tegen bestaand beton	:	Nee		Nee			
Element met plaatgeometrie	:	Nee		Nee			
Specifieke kwaliteitsbeheersing	:	Nee		Nee			
Oneffen beton oppervlak	:	Nee		Nee			
Ondergrond	:	Glad / N.v.t.		Glad / N.v.t.			
Constructieklasse	:	S4		S4			
Grootste korrel	:	31.5					
Hoofdwapening	:	2de laag		2de laag			
Nominale dekking	:	30		30			
Toegepaste dekking	:	43		48			
Gelijkwaardige diameter	:	10		10			
$C_{min,b}$ $C_{min,dur}$ ΔC_{dur}	:	10	25	0	10	25	0
C_{min} ΔC_{dev} C_{nom}	:	25	5	30	25	5	30
Beugel / Verdeelwapening	:	1ste laag		1ste laag			
Nominale dekking	:	30		30			
Toegepaste dekking	:	35		40			
Gelijkwaardige diameter	:	8		8			
$C_{min,b}$ $C_{min,dur}$ ΔC_{dur}	:	8	25	0	8	25	0
C_{min} ΔC_{dev} C_{nom}	:	25	5	30	25	5	30
Minimale beugelafstand	:	50	Theta [graden] :		21.8		
Uitg.p. inw.hefboomsarm z	:	MRd					

BELASTING

Trek aan de	:	onderzijde
Nd [kN]	:	0.0

Dwarskrachten [kN] bij verschillende beugels en hoh-afstanden

Diameter	Bgl.	z	H.o.h.-afstanden beugels [mm]
[mm]	/drsn	[mm]	300

8.0	4	393.6	286.79
Diameter [mm]	Bgls. /drsn	$V_{Rd,c}$ [kN]	$V_{Rd,max}$ [kN]
8.0	4	130.03	799.20

dwarskracht tussenbalk b1000mm

GEOMETRIE

Elementtype : Balk
 Betonkwaliteit : C20/25
 Soort spanningsrekdiagram : Parabolisch - rechthoekig diagram
 Doorsnede vorm : Rechthoek
 Afmetingen : b=800 h=550
 Referentieperiode : 50 jaar

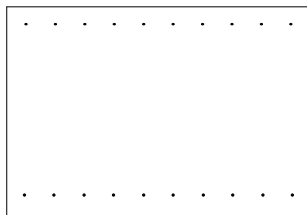

WAPENING

Staalkwaliteit : B500B
 Soort spanningsrekdiagram : Bi-lineair diagram met klimmende tak
 Toevallige inklemming : nee

	Boven	Onder
Toegepaste wapening :	10x10	10x10
Breedte stort sleuf :	50	

Betondekking

	Boven	Onder
Milieu :	XC3	XC3
Gestort tegen bestaand beton :	Nee	Nee
Element met plaatgeometrie :	Nee	Nee
Specifieke kwaliteitsbeheersing :	Nee	Nee
Oneffen beton oppervlak :	Nee	Nee
Ondergrond :	Glad / N.v.t.	Glad / N.v.t.
Constructieklasse :	S4	S4
Grootste korrel :	31.5	

Hoofdwapening :	2de laag	2de laag
Nominale dekking :	30	30
Toegepaste dekking :	43	48
Gelijkwaardige diameter :	10	10
$C_{min,b}$ $C_{min,dur}$ ΔC_{dur} :	10 25 0	10 25 0
C_{min} ΔC_{dev} C_{nom} :	25 5 30	25 5 30

Betondekking

	Boven			Onder			
Beugel / Verdeelwapening	:	1ste laag			1ste laag		
Nominale dekking	:	30			30		
Toegepaste dekking	:	35			40		
Gelijkwaardige diameter	:	8			8		
$C_{min,b}$ $C_{min,dur}$ ΔC_{dur}	:	8	25	0	8	25	0
C_{min} ΔC_{dev} C_{nom}	:	25	5	30	25	5	30
Minimale beugelafstand	:	50			Theta [graden]	: 21.8	
Uitg.p. inw.hefboomsarm z	:	MRd					

BELASTING

Trek aan de	:	onderzijde
Nd [kN]	:	0.0

Dwarskrachten [kN] bij verschillende beugels en hoh-afstanden

Diameter [mm]	Bgls. /drsn	z [mm]	H.o.h.-afstanden beugels [mm]
8.0	4	441.8	321.84

Diameter [mm]	Bgls. /drsn	$V_{Rd,c}$ [kN]	$V_{Rd,max}$ [kN]
8.0	4	130.03	896.89

dwarskracht tussenbalk geen schenkels**GEOMETRIE**

Elementtype	:	Vloer
Betonkwaliteit	:	C20/25
Soort spanningsrekdiagram	:	Parabolisch - rechthoekig diagram
Doorsnede vorm	:	Rechthoek
Afmetingen	:	b=800 h=550
Referentieperiode	:	50 jaar

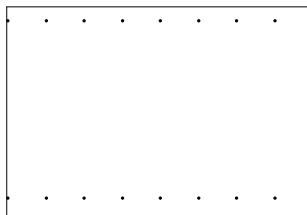
**WAPENING**

Staalkwaliteit	:	B500B	
Soort spanningsrekdiagram	:	Bi-lineair diagram met klimmende tak	
Toevallige inklemming	:	nee	
Toegepaste wapening	:	Boven	Onder
Breedte stortsluif	:	8x10	8x10
	:	50	

Betondekking		Boven	Onder
Milieu	:	XC3	XC3
Gestort tegen bestaand beton	:	Nee	Nee
Element met plaatgeometrie	:	Ja	Ja
Specifieke kwaliteitsbeheersing	:	Nee	Nee
Oneffen beton oppervlak	:	Nee	Nee
Ondergrond	:	Glad / N.v.t.	Glad / N.v.t.
Constructieklasse	:	S3	S3
Grootste korrel	:	31.5	
Hoofdwapening	:	1ste laag	1ste laag
Nominale dekking	:	25	25
Toegepaste dekking	:	35	40
Gelijkwaardige diameter	:	10	10
$C_{min,b}$ $C_{min,dur}$ ΔC_{dur}	:	10 20 0	10 20 0
C_{min} ΔC_{dev} C_{nom}	:	20 5 25	20 5 25
Minimale beugelafstand	:	50	Theta [graden] : 21.8
Uitg.p. inw.hefboomsarm z	:	MRd	

BELASTING

Trek aan de	:	onderzijde
N_d [kN]	:	0.0
$V_{Rd,c}$	[kN]:	131.5

Wapening balk as E en 5

GEOMETRIE

Elementtype	:	Balk
Betonkwaliteit	:	C20/25
Soort spanningsrekdiagram	:	Parabolisch - rechthoekig diagram
Doorsnede vorm	:	Rechthoek
Afmetingen	:	b=600 h=350
Scheurvorming volgens art	:	7.3.4
Referentieperiode	:	50 jaar

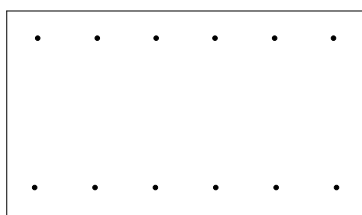

WAPENING

Staalkwaliteit	:	B500B	
Soort spanningsrekdiagram	:	Bi-lineair diagram met klimmende tak	
Beugeldiameter	:	8	
Toevallige inklemming	:	nee	
Toegepaste wapening	:	Boven 6x10	Onder 6x10
Breedte stortsluif	:	50	

Betondekking		Boven	Onder
Milieu	:	XC3	XC3
Gestort tegen bestaand beton	:	Nee	Nee
Element met plaatgeometrie	:	Nee	Nee
Specifieke kwaliteitsbeheersing	:	Nee	Nee
Oneffen beton oppervlak	:	Nee	Nee
Ondergrond	:	Glad / N.v.t.	Oneffen, voorbereid
	:		k1=35
Constructieklasse	:	S4	S4
Grootste korrel	:	31.5	
Hoofdwapening	:	2de laag	2de laag
Nominale dekking	:	30	35
Toegepaste dekking	:	43	48
Gelijkwaardige diameter	:	10	10
$C_{min,b}$ $C_{min,dur}$ ΔC_{dur}	:	10 25 0	10 25 0
C_{min} ΔC_{dev} C_{nom}	:	25 5 30	25 5 35
Beugel / Verdeelwapening	:	1ste laag	1ste laag
Nominale dekking	:	30	35
Toegepaste dekking	:	35	40
Gelijkwaardige diameter	:	8	8
$C_{min,b}$ $C_{min,dur}$ ΔC_{dur}	:	8 25 0	8 25 0
C_{min} ΔC_{dev} C_{nom}	:	25 5 30	25 5 35

BELASTING

RESULTATEN

Nr					Sterkte		Scheurvorming		Opm.
	N_{Ed} [kN]	M_{Ed} [kNm]	$N_{E;freq}$ [kN]	$M_{E;freq}$ [kNm]	M_{Rd} [kNm]	M_{Rd} [kNm]	$M_{R;freq}$ [kNm]	$M_{R;freq}$ [kNm]	
1	0.0	0.0	0.0	0.0	62.4	-60.9	43.5	-42.2	

dwarskracht balk as E en 5

GEOMETRIE

Elementtype : Balk
 Betonkwaliteit : C20/25
 Soort spanningsrekdiagram : Parabolisch - rechthoekig diagram
 Doorsnede vorm : Rechthoek
 Afmetingen : b=600 h=350
 Referentieperiode : 50 jaar

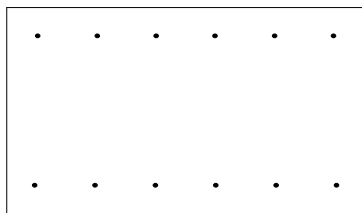

WAPENING

Staalkwaliteit	:	B500B		
Soort spanningsrekdiagram	:	Bi-lineair diagram met klimmende tak		
Toevallige inklemming	:	nee		
			Boven	Onder
Toegepaste wapening	:		6x10	6x10
Breedte stort sleuf	:		50	

Betondekking

			Boven		Onder		
Milieu	:		XC3		XC3		
Gestort tegen bestaand beton	:		Nee		Nee		
Element met plaatgeometrie	:		Nee		Nee		
Specifieke kwaliteitsbeheersing	:		Nee		Nee		
Oneffen beton oppervlak	:		Nee		Nee		
Ondergrond	:		Glad / N.v.t.		Glad / N.v.t.		
Constructieklasse	:		S4		S4		
Grootste korrel	:		31.5				
Hoofdwapening	:		2de laag		2de laag		
Nominale dekking	:		30		30		
Toegepaste dekking	:		43		48		
Gelijkwaardige diameter	:		10		10		
$C_{min,b}$ $C_{min,dur}$ ΔC_{dur}	:	10	25	0	10	25	0
C_{min} ΔC_{dev} C_{nom}	:	25	5	30	25	5	30
Beugel / Verdeelwapening	:		1ste laag		1ste laag		
Nominale dekking	:		30		30		
Toegepaste dekking	:		35		40		
Gelijkwaardige diameter	:		8		8		
$C_{min,b}$ $C_{min,dur}$ ΔC_{dur}	:	8	25	0	8	25	0
C_{min} ΔC_{dev} C_{nom}	:	25	5	30	25	5	30
Minimale beugelafstand	:	50	Theta [graden]	:	21.8		
Uitg.p. inw.hefboomsarm z	:	MRd					

BELASTING

Trek aan de	:	onderzijde
N_d [kN]	:	0.0

Dwarskrachten [kN] bij verschillende beugels en hoh-afstanden

Diameter [mm]	Bgls. /drsn	z [mm]	H.o.h.-afstanden beugels [mm]
8.0	4	228.6	249.80

Diameter [mm]	Bgls. /drsn	$V_{Rd,c}$ [kN]	$V_{Rd,max}$ [kN]
8.0	4	68.52	348.06