

doorsnede A-A

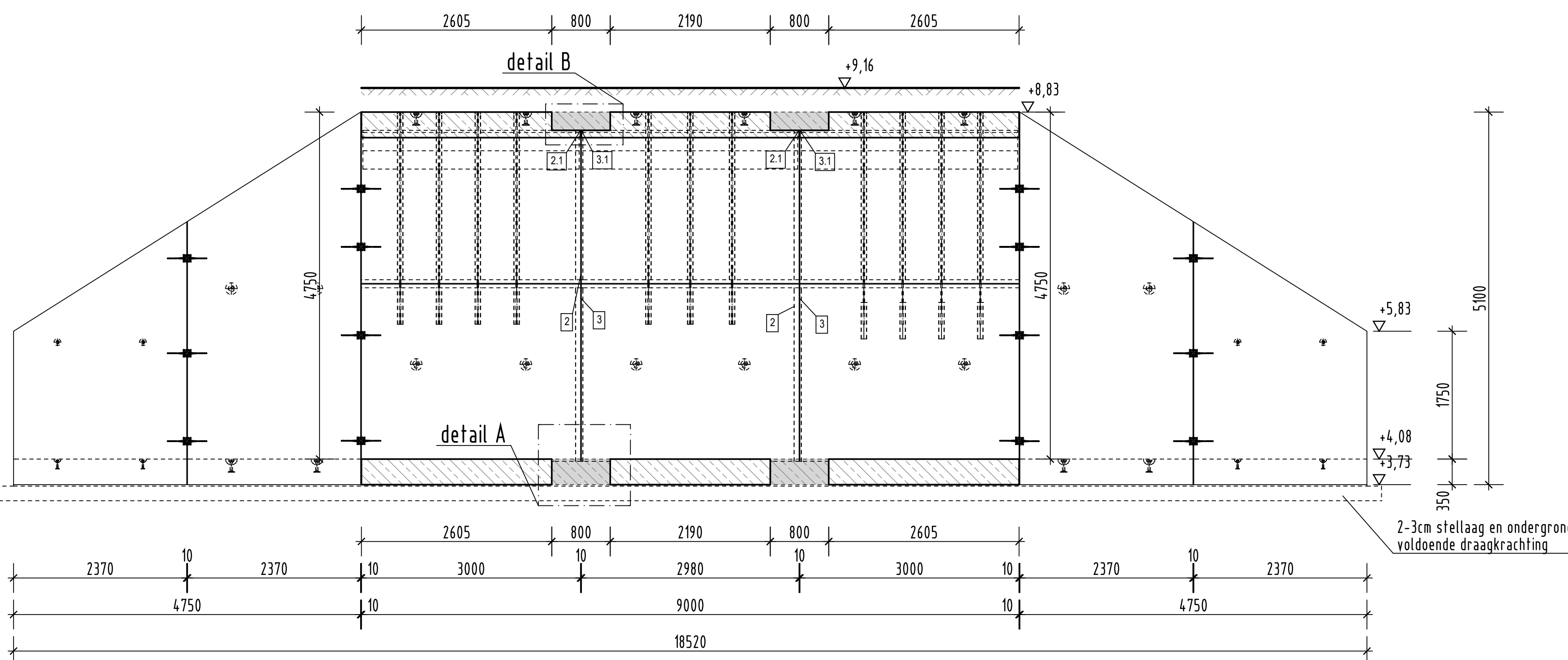

doorsnede B-B

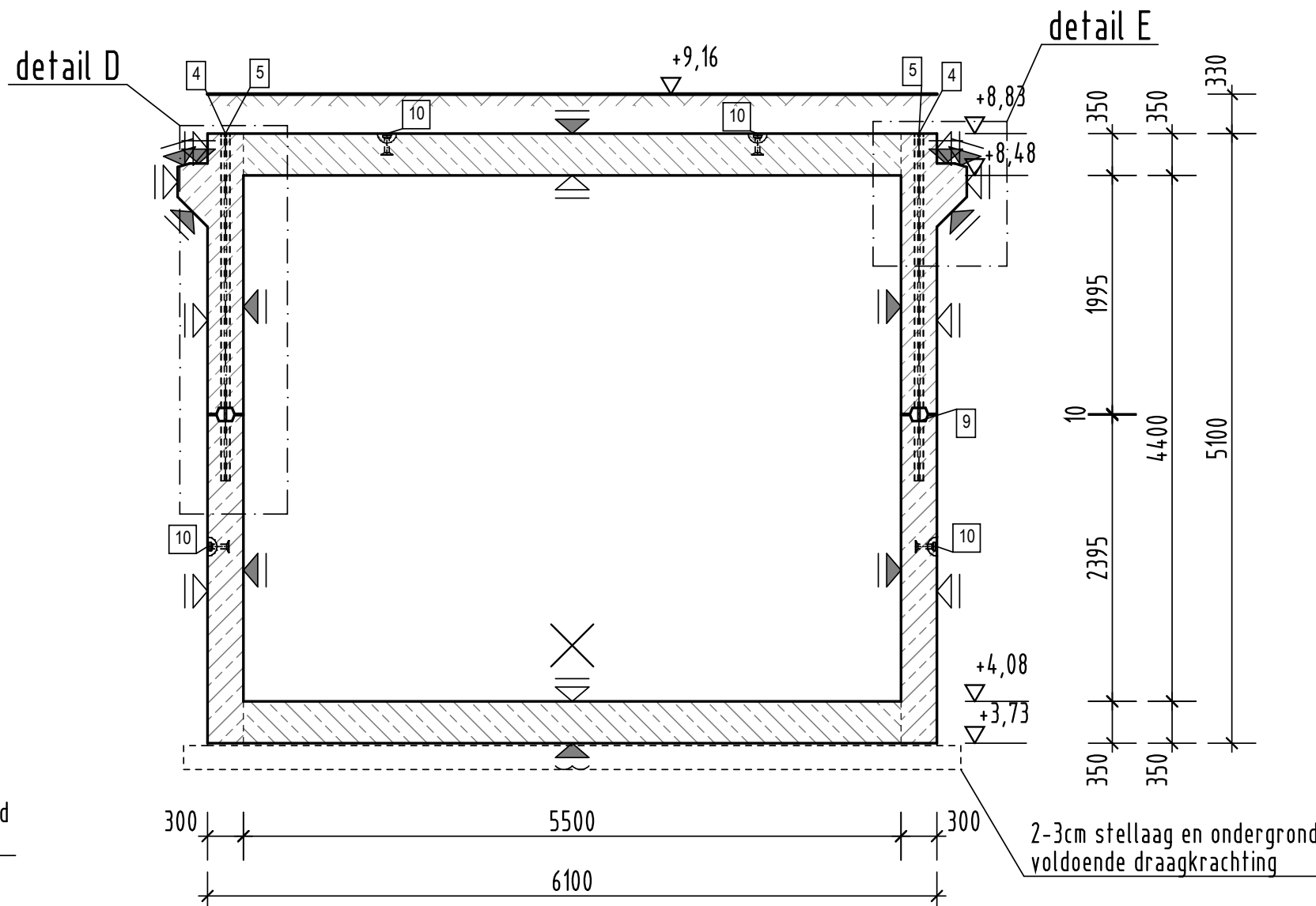

doorsnede C-C

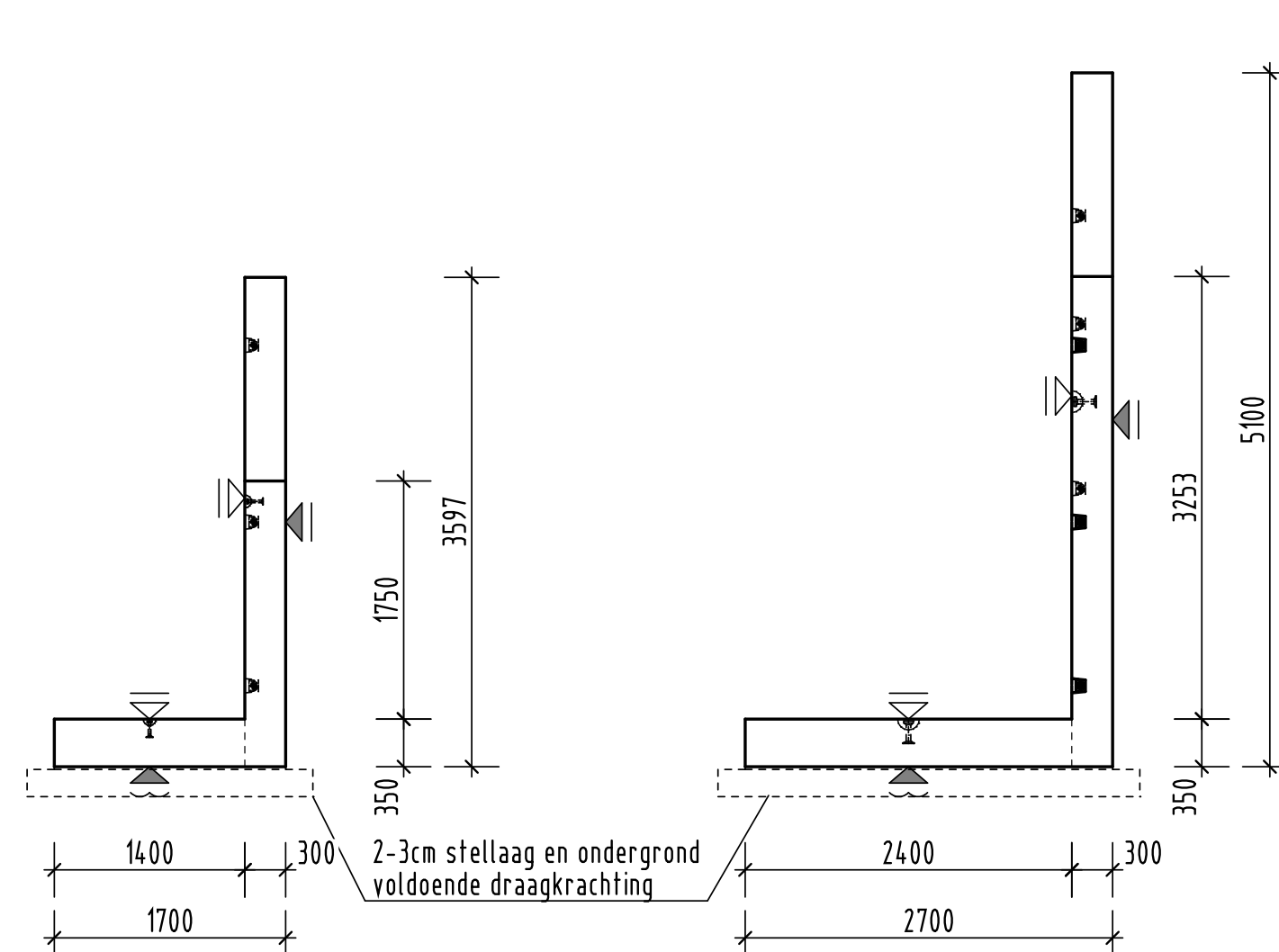

doorsnede D-D

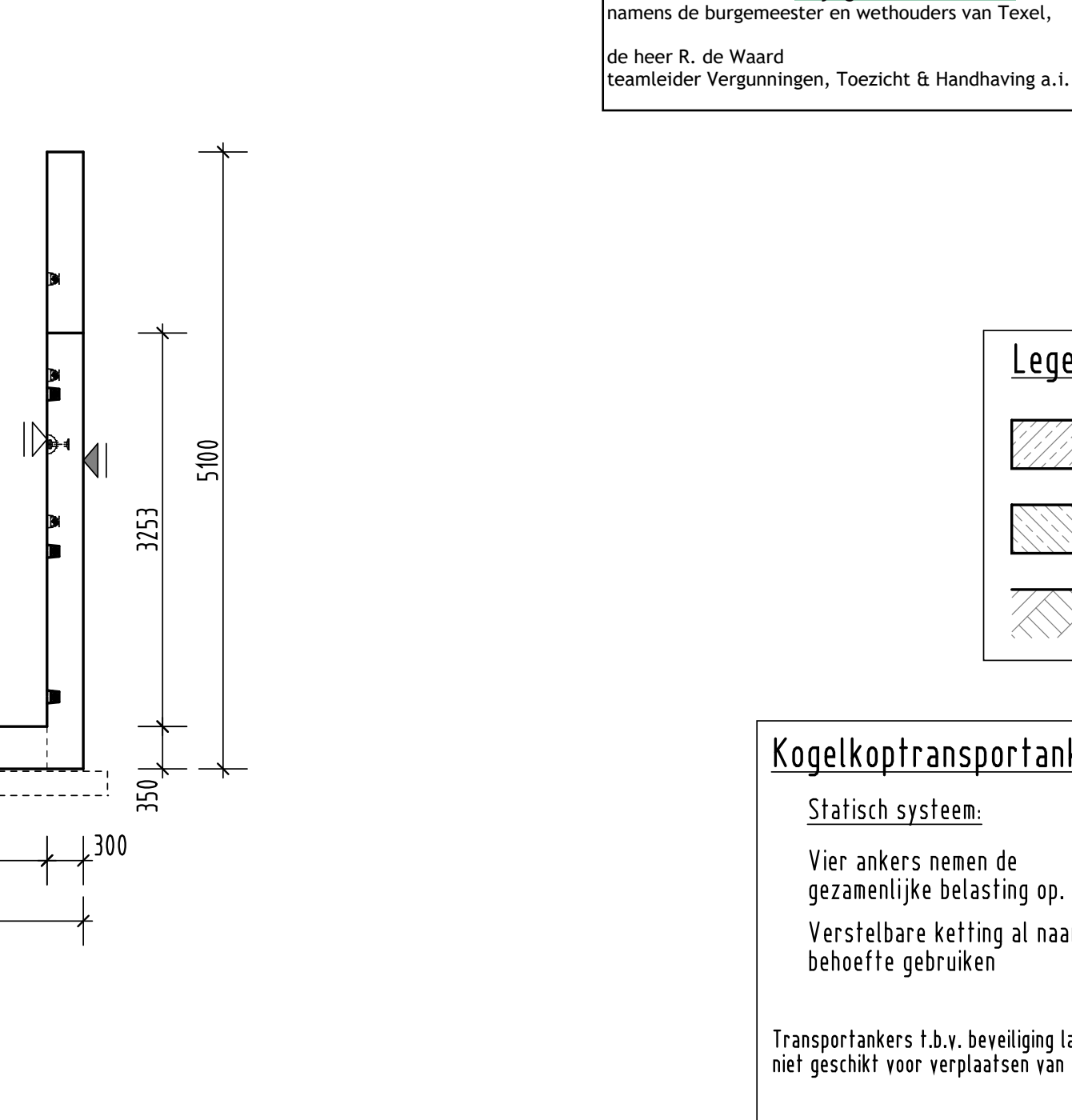

Legenda:

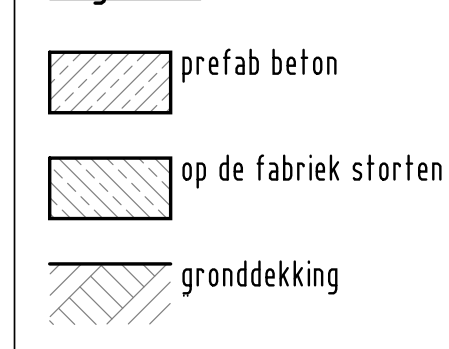

Kogelkoptransportanker

Statisch systeem:
Vier ankers nemen de gezamenlijke belasting op. Verstelbare ketting al naar behoefte gebruiken

Transportankers i.b.v. beveiliging lading zijn niet geschikt voor verplaatsen van prefab-elementen!

bovenaanzicht

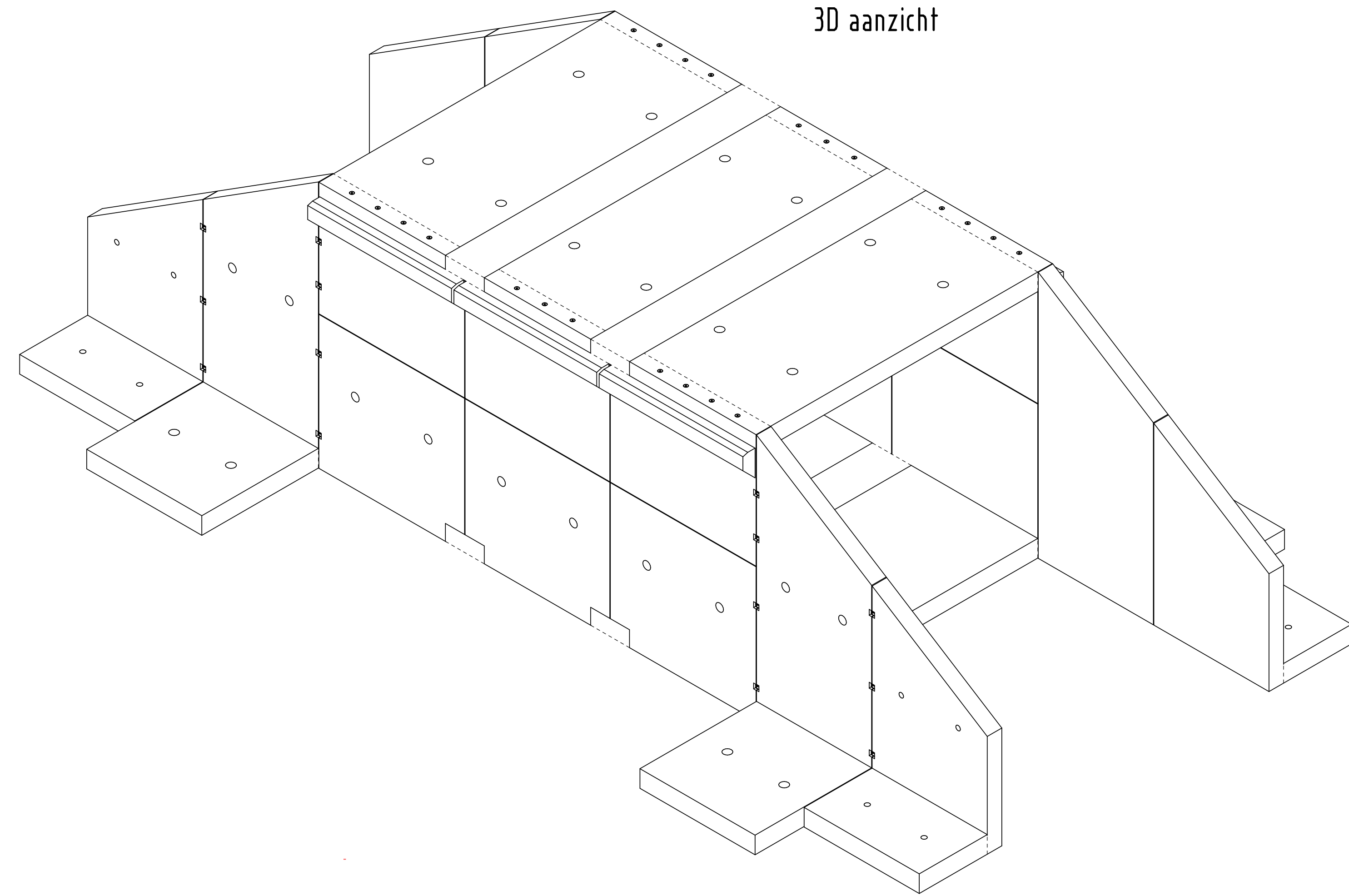
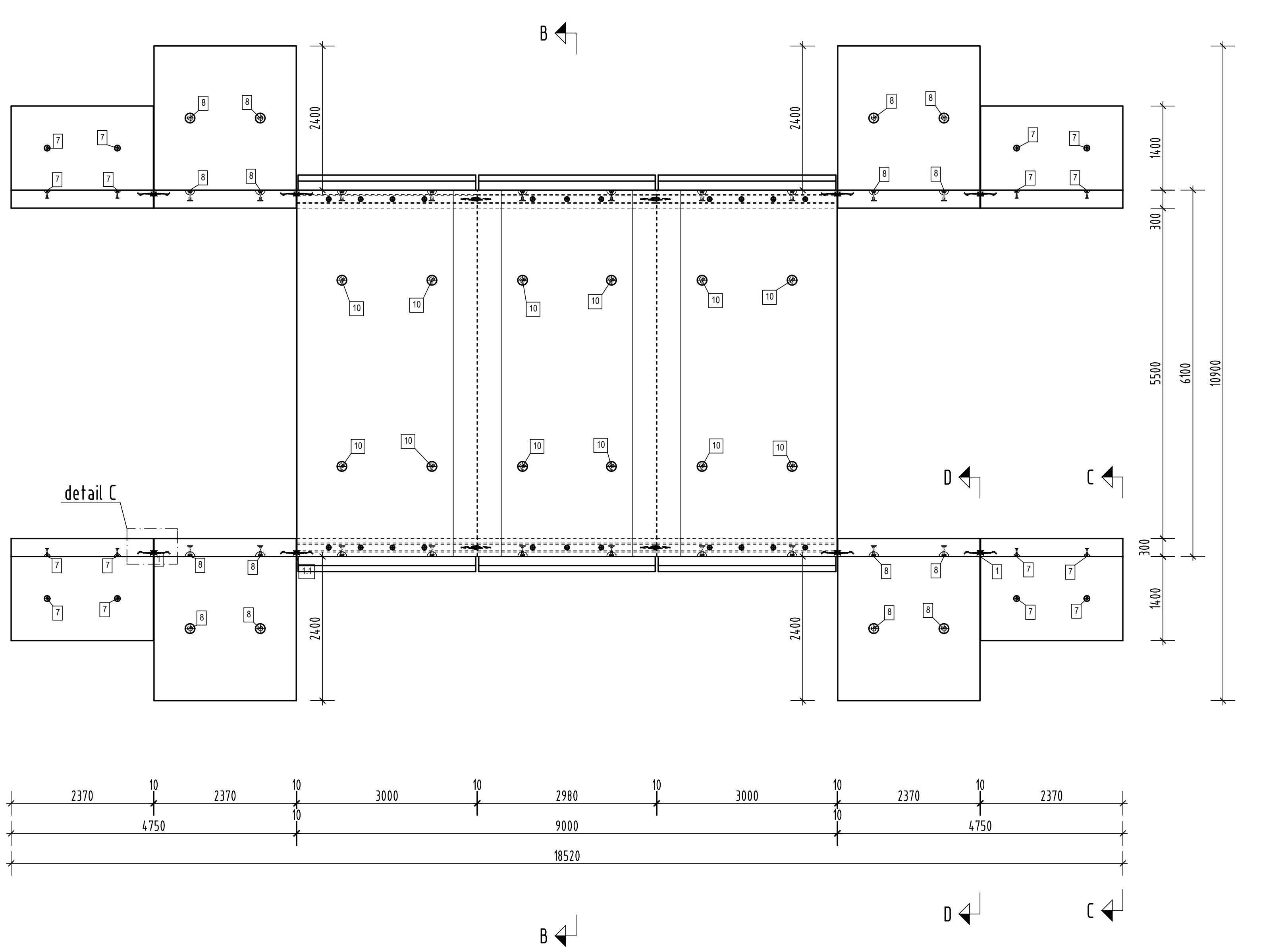

3D aanzicht

Pos.	St	Naam	Gewicht per stuk (t)	Gesamenlijk gewicht (t)	Breedte (cm)	Lengte (cm)	Hoogte (cm)
1	28	Spanstel M16 verzinkt					
2	4	Philipp Power Duo System, lusverbinding, diepte rail, lang ca. 237,5 cm	24,6	24,6	300,0	660,0	234,5
2.1	4	Philipp Power Duo System, lusverbinding, diepte rail, lang ca. 204,5 cm	23,0	23,0	298,0	660,0	234,5
3	4	Philipp Power Duo System, lusverbinding, platte rail, lang ca. 237,5 cm	24,7	24,7	300,0	660,0	234,5
3.1	4	Philipp Power Duo System, lusverbinding, platte rail, lang ca. 204,5 cm	22,7	22,7	297,0	660,0	234,5
4	22	DN 70 Sparringsbus, L=229,5 cm	8,0	15,9	170,0	237,0	359,7
5	22	DN 70 Sparringsbus, L=290,5 cm	12,7	25,4	237,0	270,0	510,0
6	36	PVC-contactplaat 10 mm dik	8,0	15,9	170,0	237,0	359,7
7	16	S.0K Kogelkop-transportanker L=120 mm	12,7	25,4	237,0	270,0	510,0
8	16	S.0K Kogelkop-transportanker L=165 mm	24,5	24,5	300,0	610,0	274,5
9	22	DN 70 Sparringsbus, L=90 cm	22,3	22,3	298,0	610,0	274,5
10	24	20.0 x Kogelkop-transportanker L=165 mm	24,8	24,8	300,0	610,0	274,5

betonoppervlakken prefab	stortzijde:	malzijde:
	onbewerkt	geen eisen
	handgespaand	schoon beton standaard
	glad afgewerkt (gespaand)	schoon beton met verhoogde eisen
	gewassen beton	gewassen beton
	gebeuzeld	gestructureerd
	keek naar speciale eisen	keek naar speciale eisen

Beton:	Xc4, XD3, XF3
Milieuklasse:	4, 0mm
Aan te houden dekking betonstaaf:	B 500 B
Betonstaaf:	C 45/55, CEM III
Sterkteklasse:	BMI/verkeerscategorie 4 /CC2/onwerklevensduur 50 jaar
Belasting:	4b
KOMO-Categorie:	

f	d	c	b	a
w/ijz:				d/atie:
o/n/rijzing:				g/ijf:

project: **Badweg Kogerstrand te DE Koog**

GVB nr.: 24-0035

naam: **Giverbo**

datum: 26.08.2024

handtekening:

sch/af: 1/25

tekening nr.: 22400601

Giverbo LEVERANCIER VOOR WEG- EN WATERBOUW

Postbus 1545
2201 GK Oude Koopstrand
Tel: 0184 43 95 00
Email: info@giverbo.nl