

Rev.	Description	Date	Sign.
A	NEW STAIRS ADDED FROM BARGE DECK TO FIRST DECK	2008-06-19	JO/FS
B	DELIVERY DRAWING	2009-04-01	JO/FS

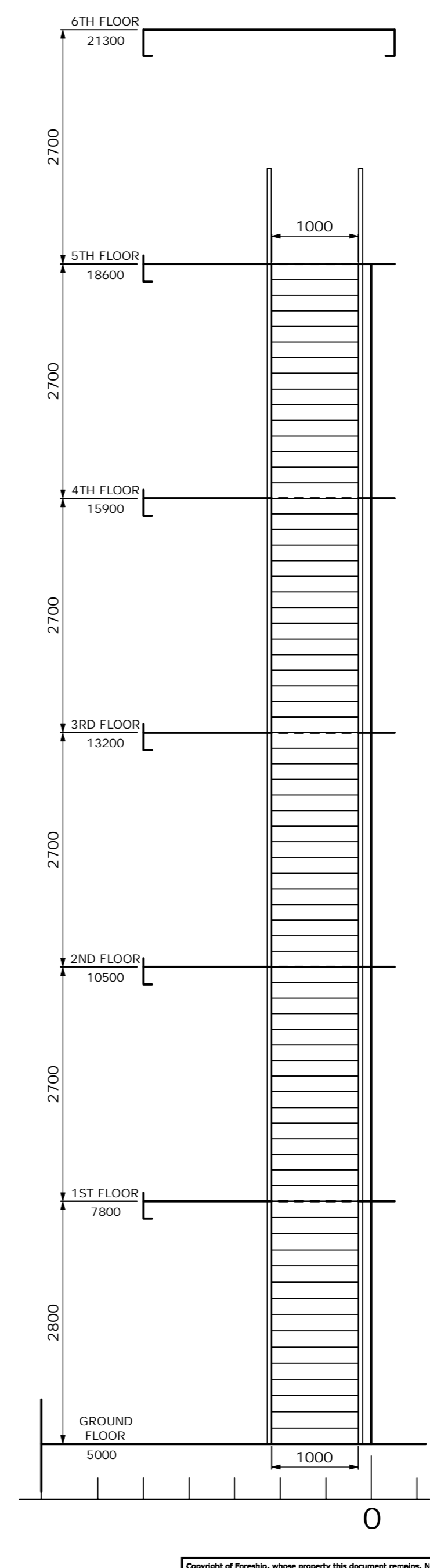
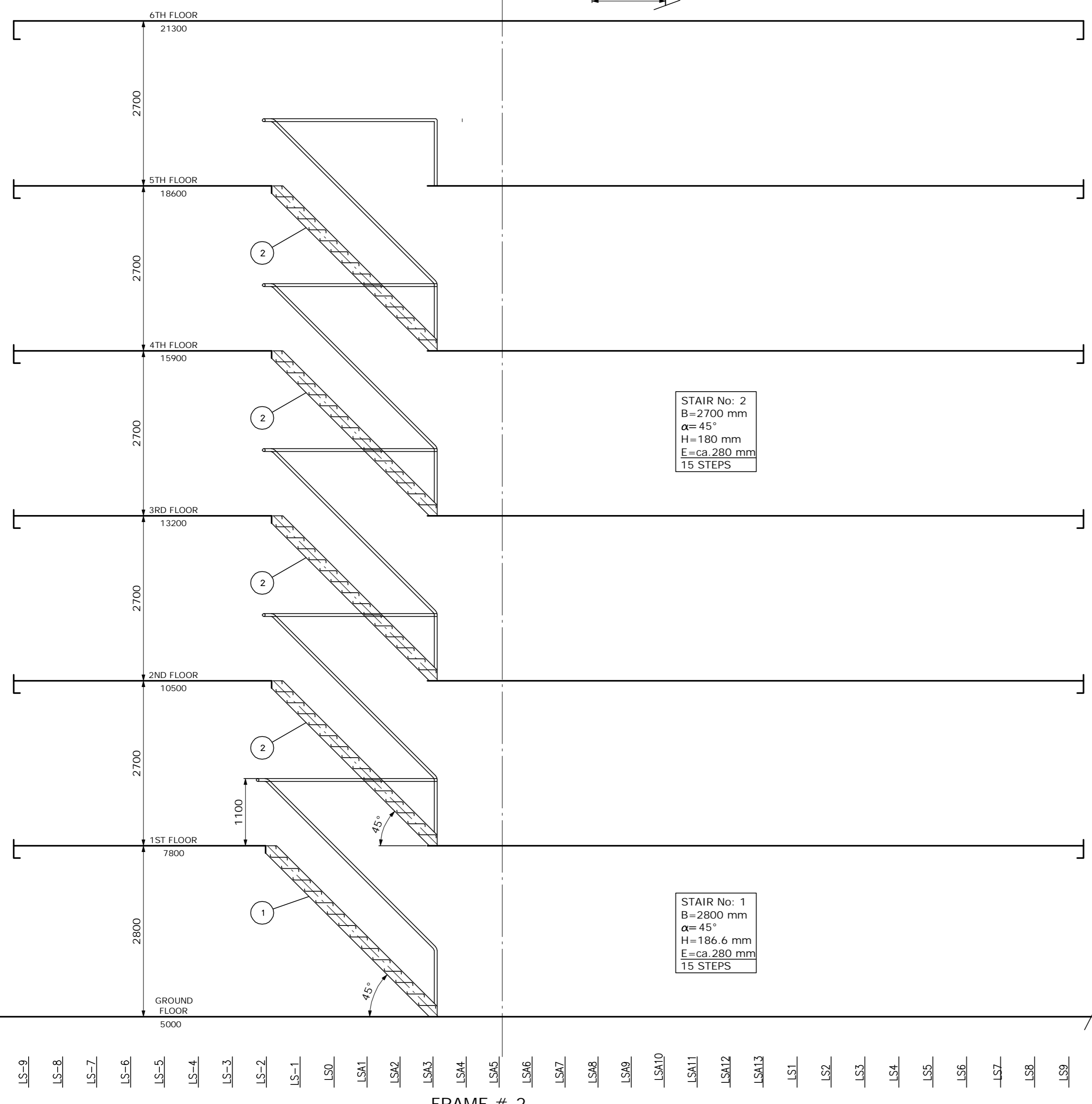
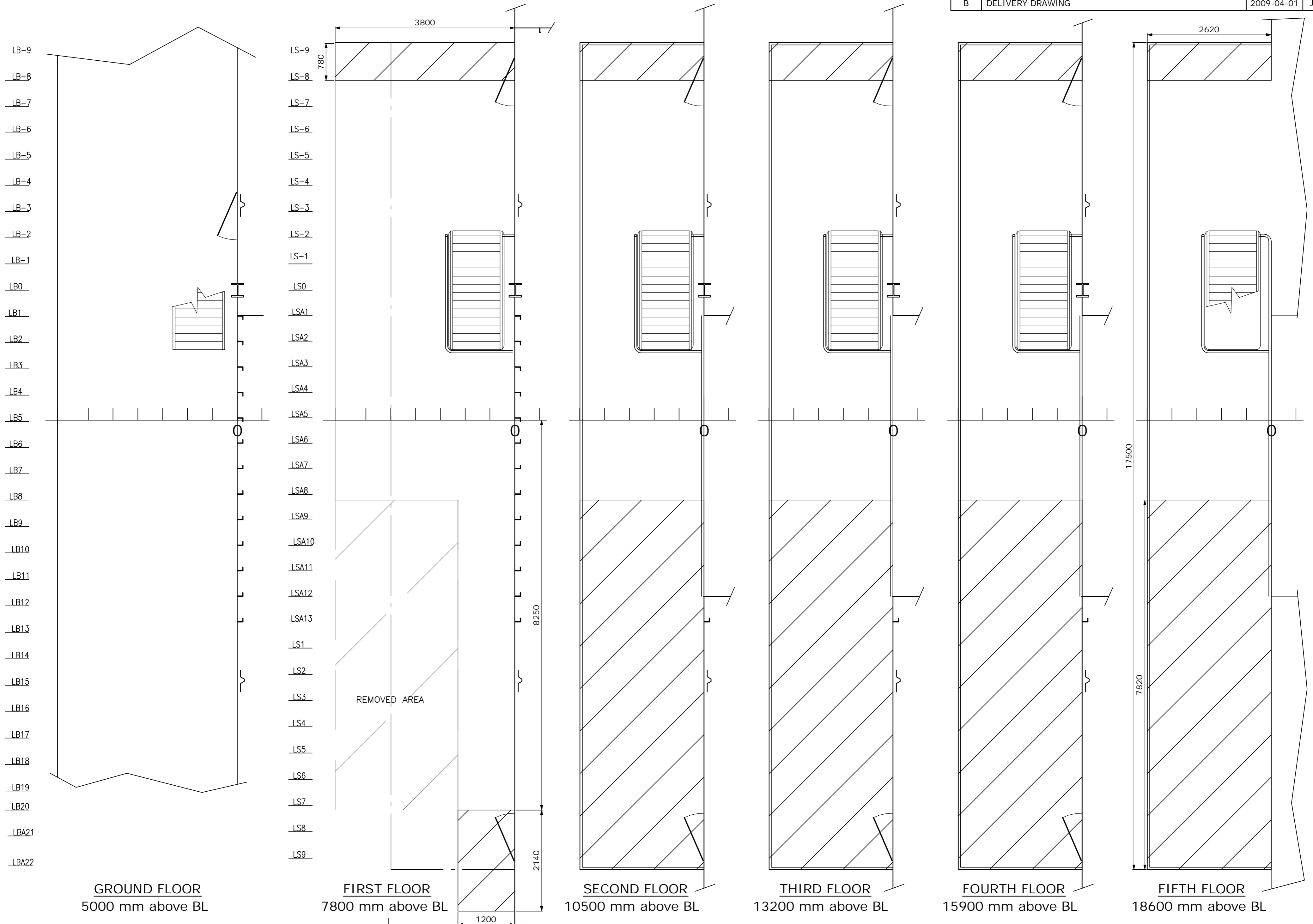

STAIR No: 2  
 B=2700 mm  
 $\alpha=45^\circ$   
 H=180 mm  
 E=ca.280 mm  
 15 STEPS

STAIR No: 1  
 B=2800 mm  
 $\alpha=45^\circ$   
 H=186.6 mm  
 E=ca.280 mm  
 15 STEPS

See also drawing:  
 D.1417.1100.002 ESCAPE STRATEGY PLAN

NOTE:  
 -TRANSVERSE SECTIONS LOOKING FORWARD  
 -HATCHED AREA NEW PLATFORM  
 -EXISTING STAIRS

	Scale:	1:50	
	Designed:	28.03.2008/PH	
Checked:	28.03.2008/JO	Drawing name:	BIBBY RENAISSANCE CONVERSION PROJECT
Project #:	1417	Arrangement of external stairs	Aft stairs
Drawing number:	D.1417.3100.007	Page:	1(2)
Revision:	B	Paper Size:	A1

Rev.	Description	Date	Sign.
A	NEW STAIRS ADDED FROM BARGE DECK TO FIRST DECK	2008-06-19	JO/FS
B	DELIVERY DRAWING	2009-04-01	JO/FS

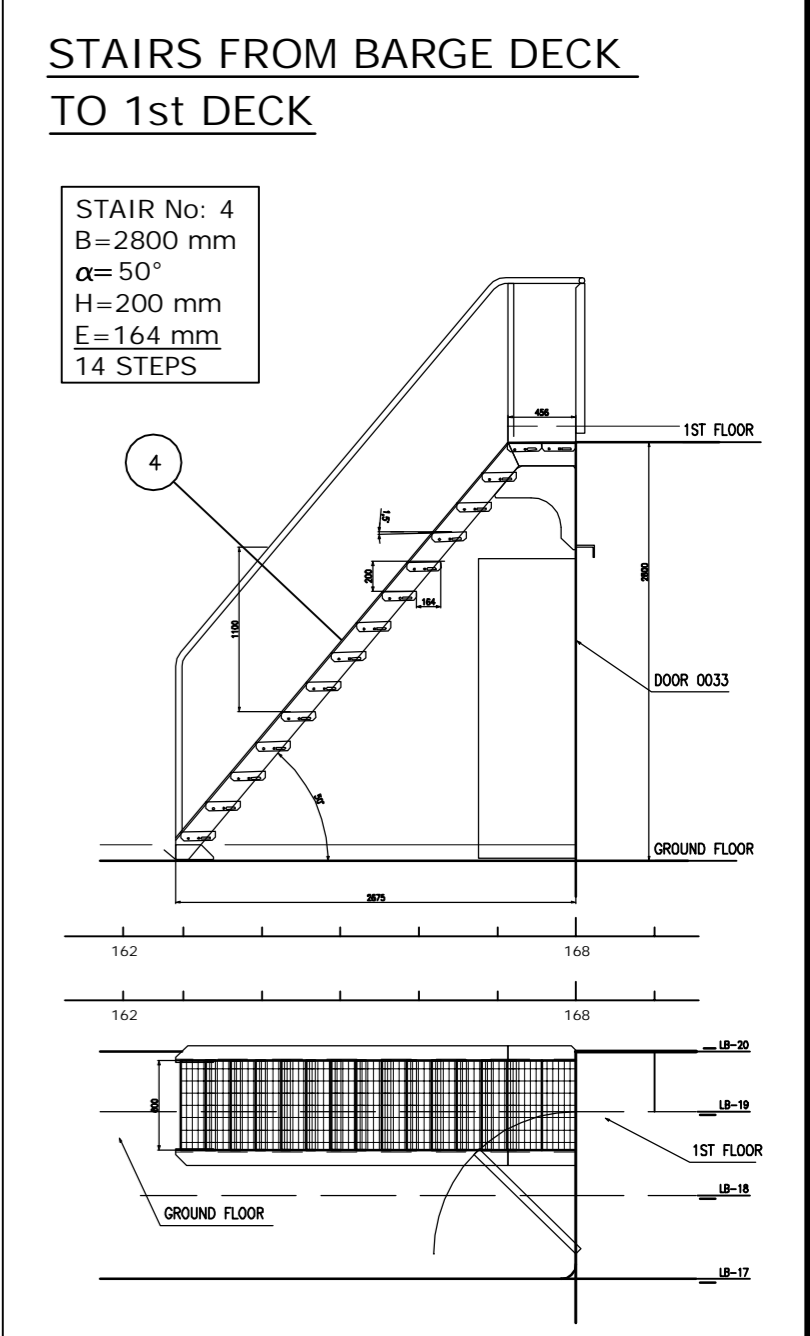
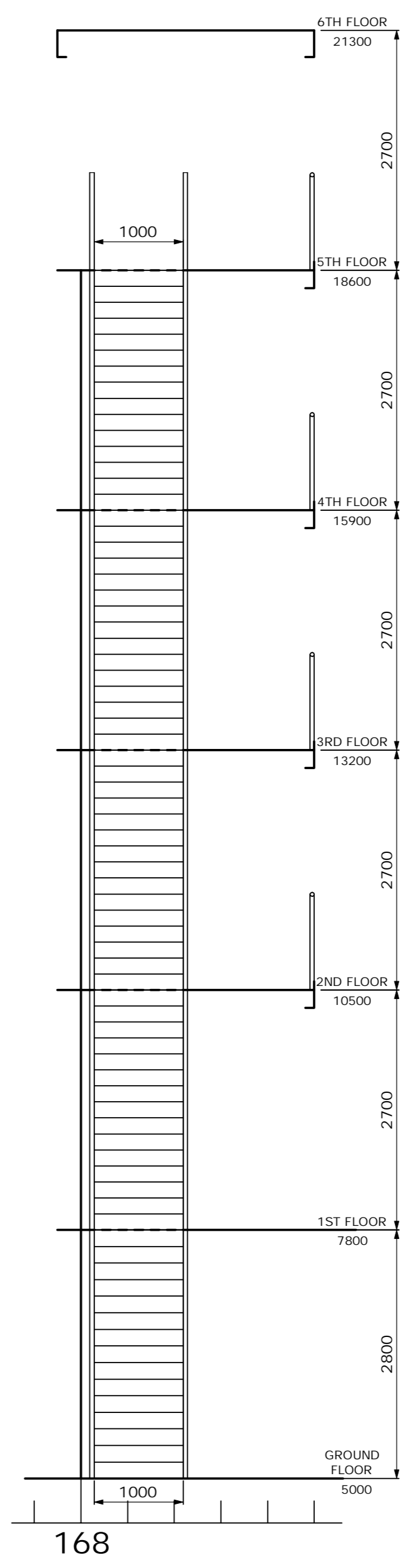
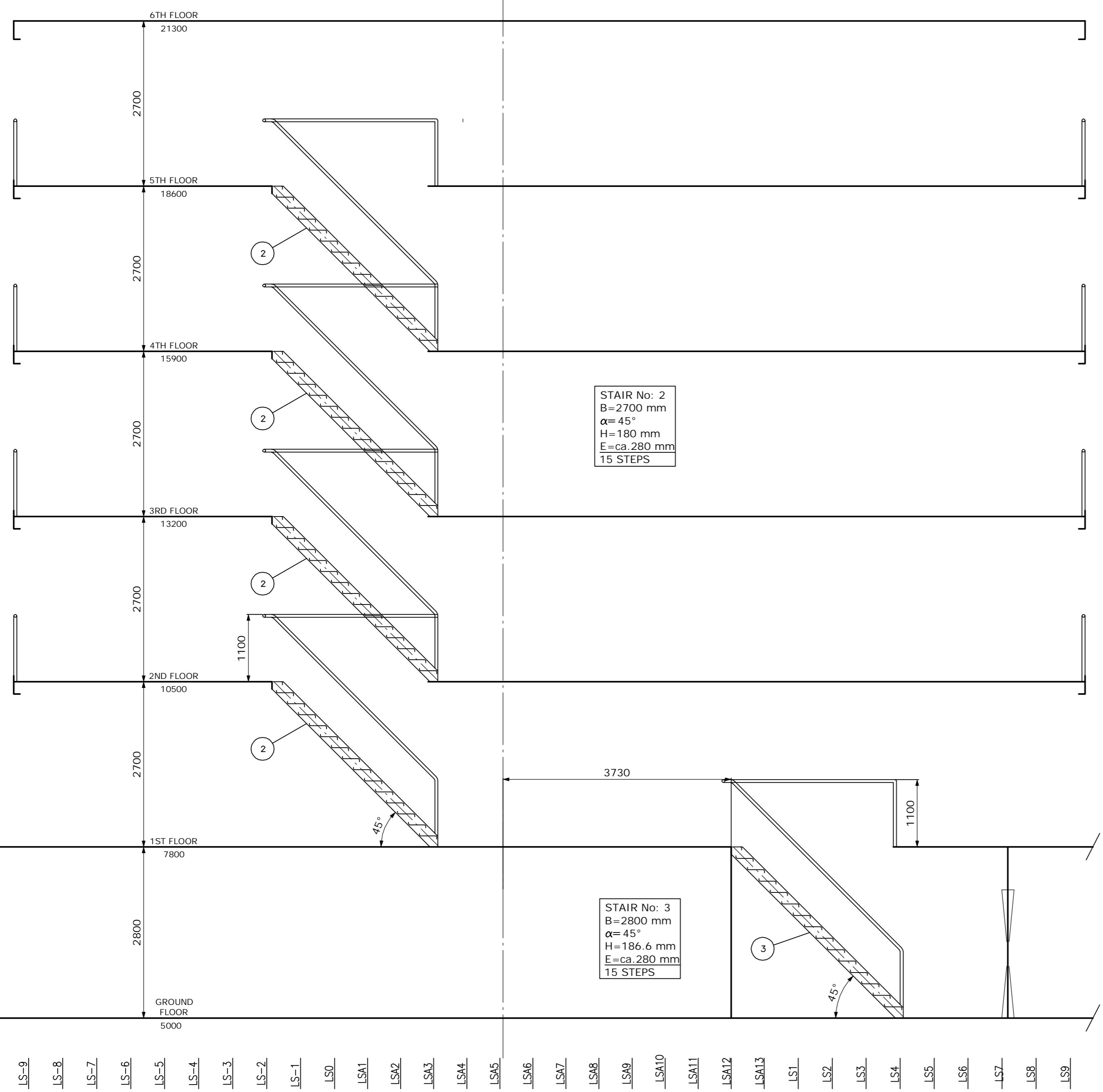
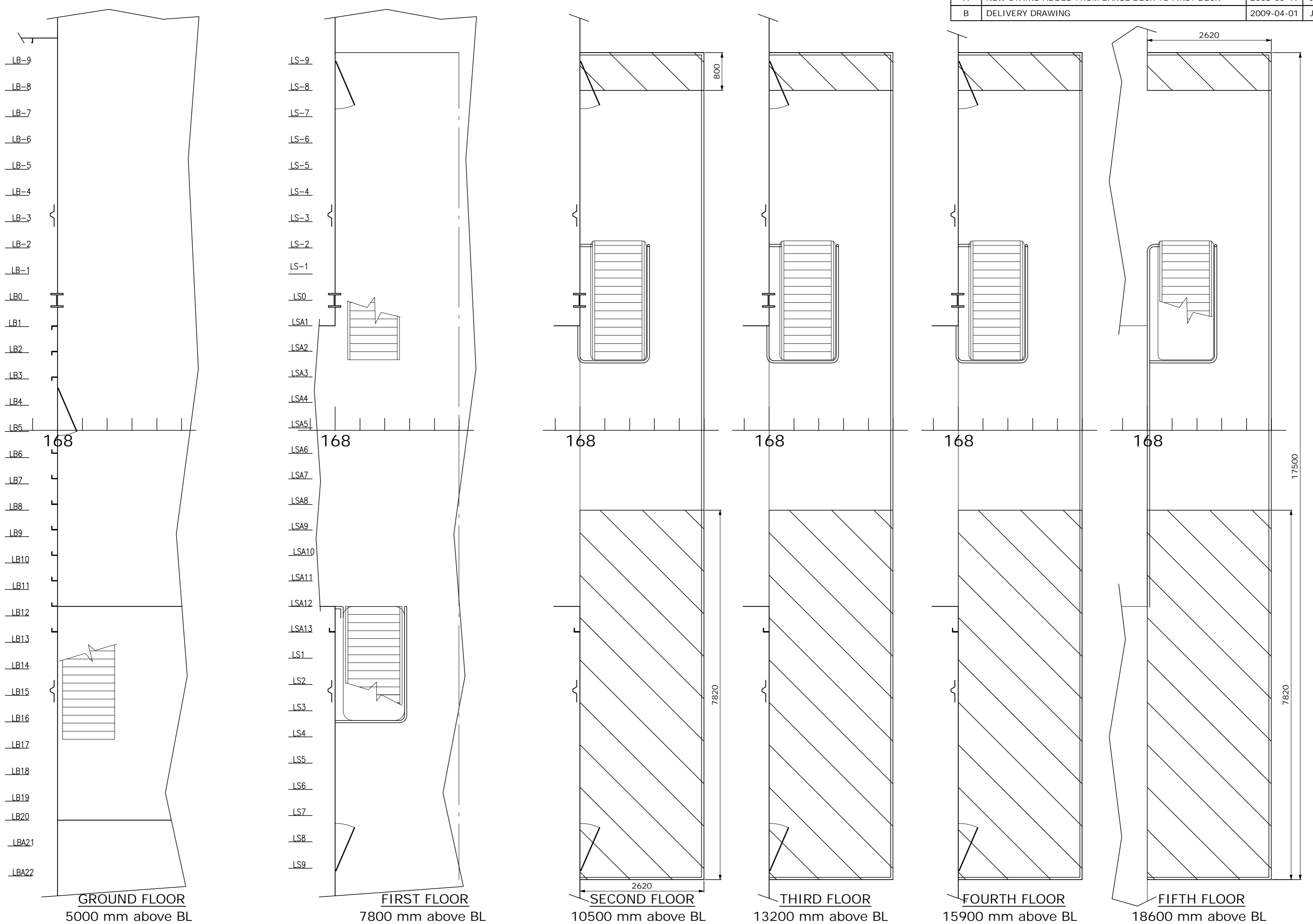

FRAME #169

See also drawing:  
 D.1417.1100.002 ESCAPE STRATEGY PLAN

NOTE:  
 -TRANSVERSE SECTIONS LOOKING FORWARD  
 -HATCHED AREA NEW PLATFORM  
 -EXISTING STAIRS UNLESS OTHERWISE SHOWN

	Scale:	1:50	Owner logo:		
	Designed:	28.03.2008/PH	Drawing name:		Arrangement of external stairs Forward stairs
	Checked:	28.03.2008/JO	Project #:	1417	
	Project #:	1417	Drawing number:	D.1417.3100.007	
		Page:	2(2)	Revision:	B

Paper Size: A1