

Slot klemt onder topring

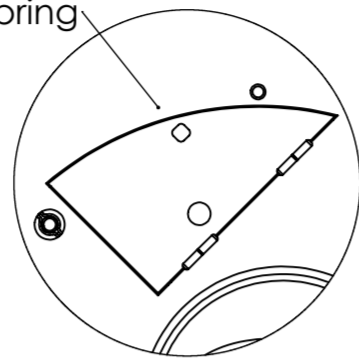

DETAIL C
SCALE 1 : 10

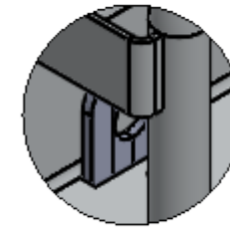

DETAIL D
SCALE 1 : 5

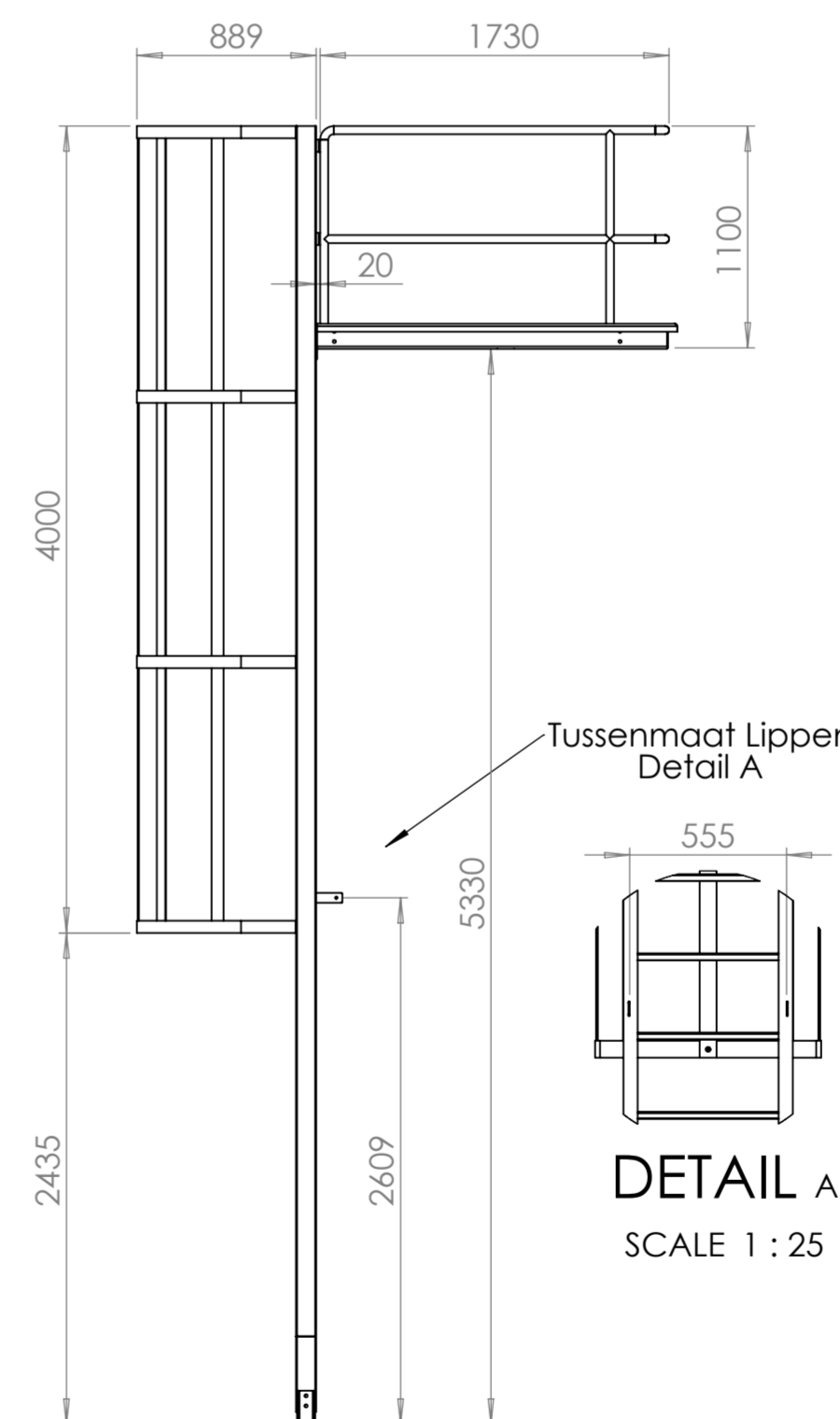
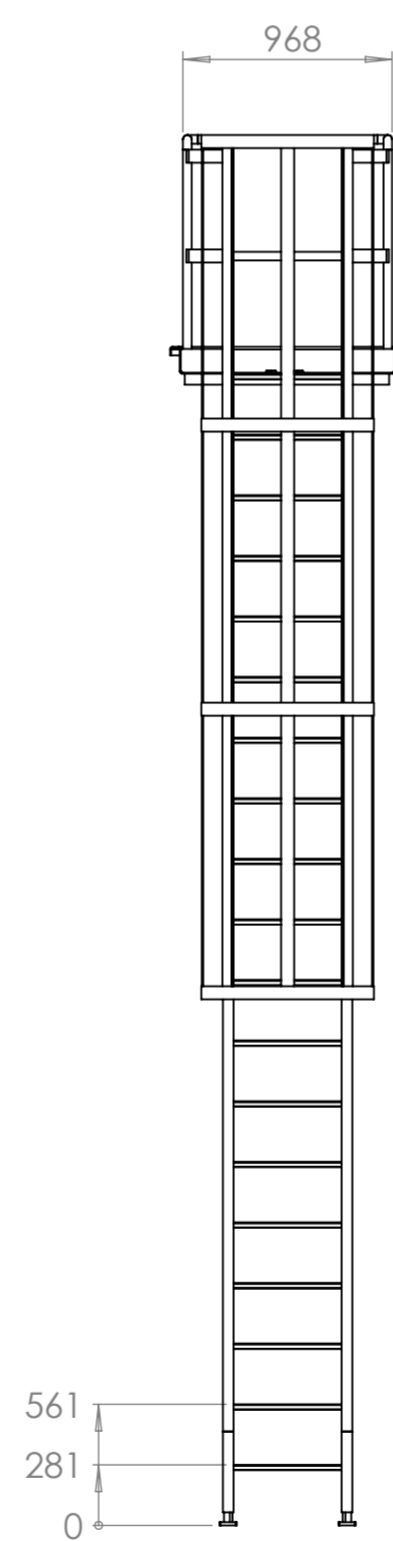
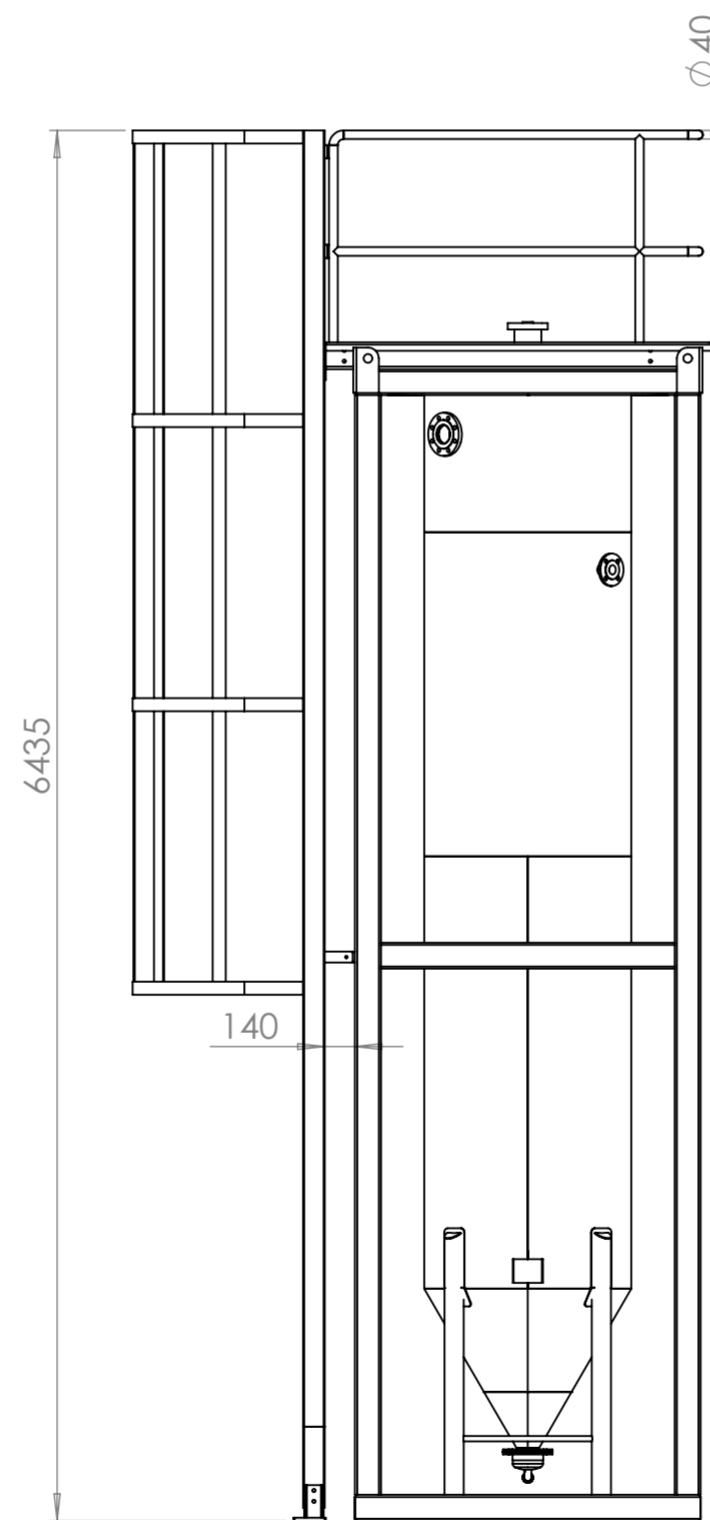
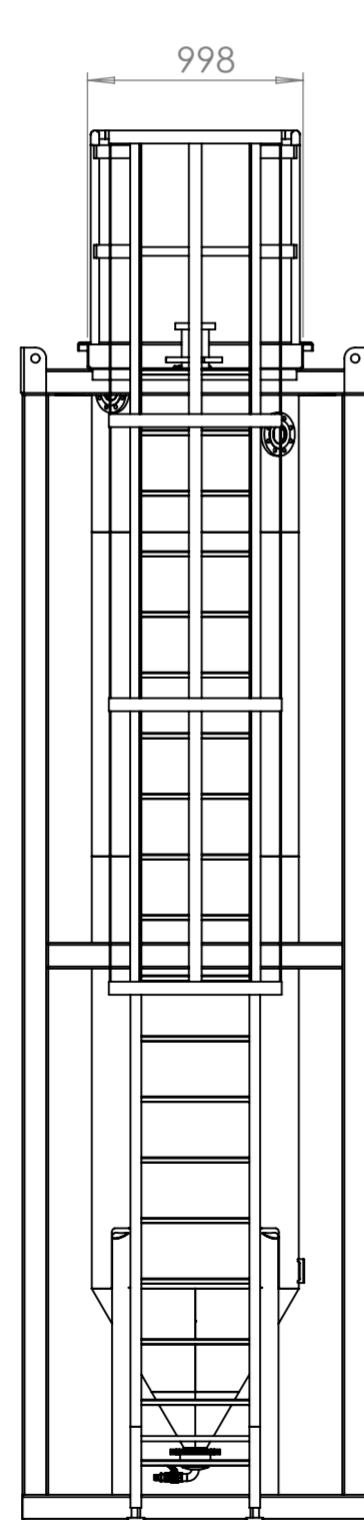

Tussenmaat Lippen
Detail A

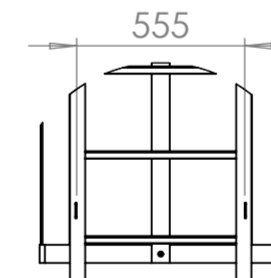

DETAIL A
SCALE 1 : 25

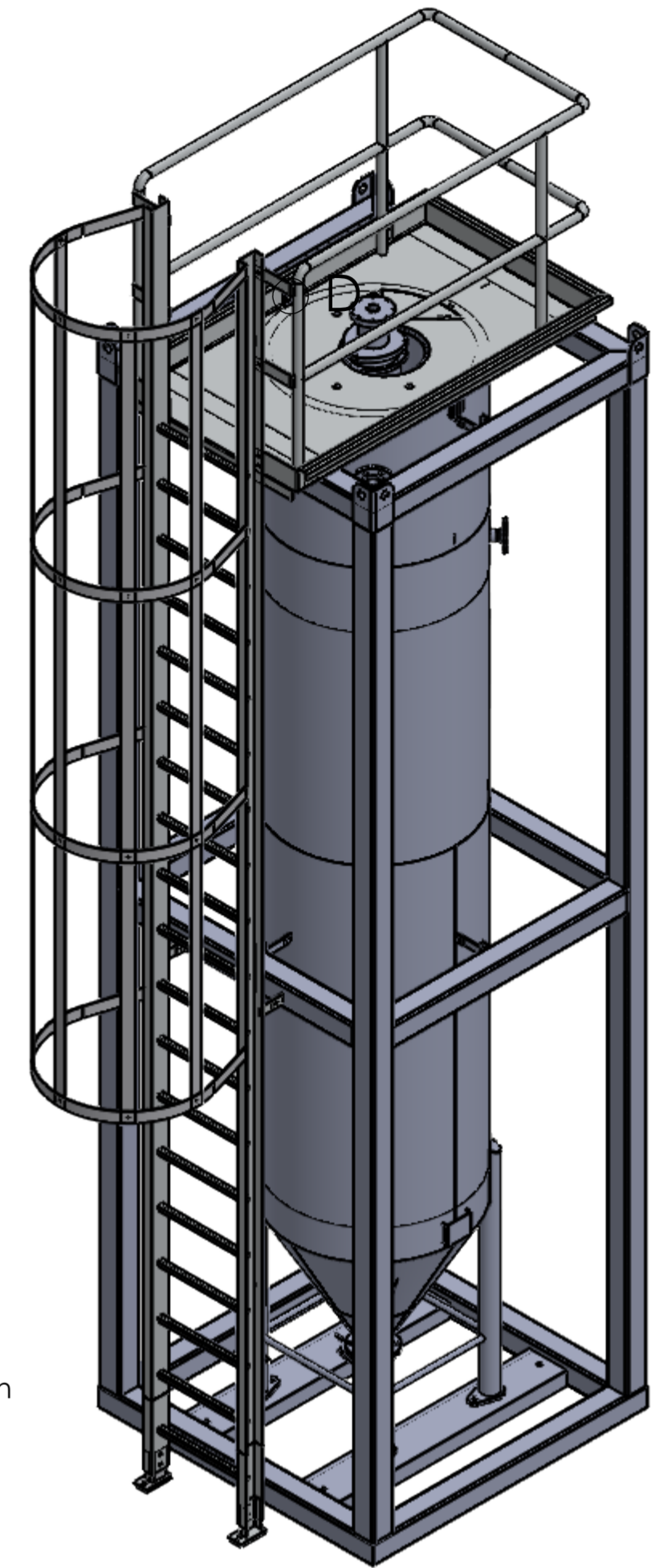

Opgebouwd uit:
Strip 60x6
Buis Ø40x2,5
U-profiel 100x50x5
Tranenplaat 5/6,5
Materiaal AlMg
Geen conservering

F					
E					
D					
C					
B					
A					
REVISIE	WIJZIGING	DATUM	GETEKEND	FORMAAT	TEKENING
				A2	202008 - DWG
GETEKEND			DATUM	OPDRACHTGEVER	BESTEMMING
					ORDERNR.
PROPRIETARY AND CONFIDENTIAL The information contained in this drawing is the sole property of VConsyst. Any reproduction in part or as a whole without the written permission of VConsyst is prohibited.					
GEWICHT kg	TOLERANTIES ISO 2768-mK	EENHEID mm	PROJECTIE ☉	SCHAAL 1:50	SHEET 1 van 1



VConsyst Metaalwerken B.V.
De Klok 3 - 8401 CM Gorredijk
info@vconsyst.com - www.vconsyst.com

BENAMING

FORMAAT A2 **TEKENING** 202008 - DWG **REVISIE**

OPDRACHTGEVER **BESTEMMING** **ORDERNR.**